



MEDICAL

3B Scientific



Printed on paper from
a sustainable forest company

3Bscientific.com

...going one step further

*Anatomy
Childbirth
Gynaecology
Cells & Genetics*

*Health Care
Medical Measures
Surgery
Resuscitation*

*Recovery
Acupuncture
Wall Charts
Software*



Otto H. Gies, Managing Director

Dear Customer!

We prefer building new models and simulators with you. You, our customers came up with important suggestions for the development of our realistic and value-for-money reanimation simulator, "Basic Billy" on page 4, the sclerotherapy simulator on page 6, and the pathological models on pages 7 and 12.

We also get our inspiration however from new technologies, such as for instance, the Micro-CT based teaching models, spongy bone and auditory ossicles, on pages 8 and 9. Our enlargements of these small structures are totally true to the original.

The impetus for innovations may come from anywhere – there is a large number competent people who are working together to provide you with accurate, high-quality, and affordable materials. Let's strengthen the backbone of medicine together: training and advanced studies.

Yours sincerely,

Otto H. Gies



page 7



page 8



page 4



Printed on paper from a sustainable forest company

Copyright © 2011, 3B Scientific GmbH, Hamburg. Unauthorized reproduction and publication of this material is strictly forbidden.

Further 3B Scientific® Catalogues

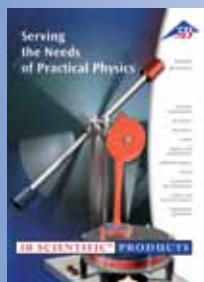

Physics



Acupuncture



Therapy

3B Scientific offers even more great products such as the good, and value for money 3B Scientific® Kinesiology and Acu-Tapes.



Committed to quality



































































3B Scientific provides you with good quality at fair prices. Our sophisticated quality management complies with the ISO 9001:2000 standards and the Worlddidac Quality Charter and is regularly approved by independent experts

That's something you can rely on.





The MEDart™ model in the title can also be found on page 172.

NEW

	New Products	4		Medical Techniques	120
	Anatomy	13		Cricothyrotomy and Tracheotomy	120
	Histology	13		Catheterisation	121
	Microscopes	13		Bedsore Care	122
	Specimens	16		Stoma Care	123
	Skeleton & Bones	25		Stitching Techniques	124
	Skull	31		Amputation/Wound Dressings	125
	Spine	34		Auscultation	126
	Models of Vertebrae	35		Blood Pressure	127
	Spinal Disorders	37		Breast Examination	128
	Pelvis	39		Testicles and Prostate	129
	Joints	42		Otoscopy	130
	Muscular Figure	46		Injection and Puncture	131
	Arm and Leg Muscles	48		Intubation	140
	Torso	56		Surgery	143
	Skin	57		Resuscitation Basic Measures	146
	Head	58		Baby/Child	146
	Teeth	61		Adult	148
	Brain	64		Resuscitation Extended Measures	155
	Nervous System	65		Baby/Child	155
	Eyes	68		Adult	158
	Nose	69		Recovery and Accident Simulation	163
	Ears	71		Rescue Manikins	163
	Larynx	72		Wound Simulation	164
	Lungs	72		Acupuncture	166
	Heart	75		Medart™	169
	Blood Vessels	76		Fun Products	177
	Intestinal Tract	79		Index	179
	Pregnancy	82			
	Childbirth	84			
	Gynaecology	90			
	Cells & Genetics	93			
	Software	95			
	Health Education	98			
	Child	98			
	Contraceptive Methods	99			
	Health Care	100			
	Baby	100			
	Child	102			
	Adult	103			
	Wall Charts	108			

KEY

-  = Extra carriage charges
-  = Self-assembly
-  = Product supplied with product manual
- www.** = Product manual available at www.3bscientific.com
- C = Chinese, D = German, DÁN = Danish, E = English, F = French,
- FIN = Finnish, H = Hungarian, I = Italian, J = Japanese, K = Korean,
- L = Latin, NL = Dutch, NO = Norwegian, P = Portuguese, R = Russian,
- S = Spanish, SE = Swedish

NEW

9 Reasons to Buy 3B Scientific® Products:

1 Three Year Quality Warranty

If you detect material or processing defects despite appropriate handling of a product within 3 years of the invoice date, we will replace the product or remedy the defect.

2 Global Price Guarantee

You will get high quality at low prices. If you obtain a comparable product of the same quality at a lower price from anywhere else on our planet within 14 days, we will take it back and refund the full purchase price.

3 No Risk Buying

If you are dissatisfied with a 3B Scientific® Product for whatever reason, simply return it to us within 14 days for a refund, packed in original cartons and with a copy of the invoice. No questions asked!

4 Prompt Delivery

Most products are shipped from stock. That means that we will generally ship the items you ordered within 2 - 10 days without incurring unreasonable freight or express charges.

5 Special Prices

If you place an order for large numbers of 3B Scientific® Products, you may be eligible for additional savings. Please ask for your special price offer.

6 Custom Orders

We are the world's leading manufacturer of anatomical models. If you have a suggestion for a new item, or require special labelling or packaging, we will do our best to accommodate you.

7 Environment Friendly Paints and Packaging

All models are painted accurately with solvent free paints. Packaging is included in the price and is made of reusable material containing no CFCs. Only special packaging will incur an extra charge.

8 Continuous Improvement

Continual design improvements and product research are carried out in order to ensure that you receive only the very best. As a result, products may differ slightly in form or colour from those depicted here.

9 DIN EN ISO 9001 Certification

The proven quality of our service, products and organisational procedures has been DIN EN ISO 9001:2008 certified since June 2000. This approved quality management system promotes our particular commitment to innovation, product improvement and customer orientation. In addition, since the Worlddidac Quality Charter was introduced in September 2004, we have reached all related quality standards.

Your BLS Simulator for Realistic Training

Basic Billy was developed using the results of a study on depth of force and compression during cardiopulmonary resuscitation. This enabled optimal force and compression values for adults and children to be determined statistically and then precisely implemented in the product design.

- Easy to use
- Realistic and Robust
- Adult and Child



NEW



Basic Life Support Simulator "Basic Billy"

Cardiovascular failure is one of the most common causes of death. The guidelines issued by the AHA (American Heart Association) and ERC (European Resuscitation Council) show that it is not all that difficult to provide help and save lives using the correct cardiac massage and ventilation technique. Of course, Basic Billy fulfils the latest guidelines from the AHA and ERC on cardiopulmonary resuscitation (CPR) and is therefore suitable both for medical training and for first aid training in schools, clubs and first aid courses. You benefit from the following features:

- Torso with shoulders and the necessary anatomical features for finding the ideal pressure point for cardiac massage
- Head with airways for mouth-to-mouth and mouth-to-nose resuscitation
- Head tilt to open the airways
- Mask ventilation is also possible
- Realistic amount of effort and realistic minimum depth of impression with acoustic feedback at 5cm (adult) or 4.5cm (child) using two easy to change springs
- Low priced disposable airways ensure hygienic use and easy care of the mannequin
- The high quality of materials and workmanship guarantee functionality and longevity even under high operational demands
- Developed and manufactured in Germany

Supplied with a transport box (22x61x31 cm³), 2 face masks, 50 disposable airways for adults and children, keycard with adult and child algorithm for the 2010 guidelines and disinfectant.

9985-1012793

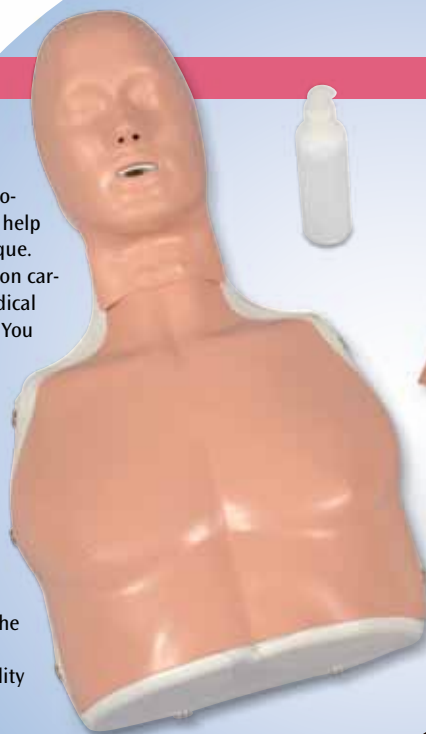

9985-1012793



MADE IN GERMANY



New Products

...going one step further

NEW



9985-1012792

Simulator for Ultrasound Guided Sclerotherapy for Varicose Veins

The current literature indicates that ultrasound guided foam sclerotherapy can be extremely effective even when treating complicated varicose veins [1]. The procedure is minimally invasive, safe and cost-efficient. In order to achieve an optimal result and minimise complications, suitable qualifications are mandatory since the precise positioning of the needle in the desired vein requires good hand-eye coordination as well as expert knowledge and experience. This simulator enables students to cost efficiently acquire the preclinical skills for ultrasound-guided microfoam sclerotherapy for varicose veins. Angiologists, phlebotomists and vascular surgeons can practice under optimal conditions since this unique 3B Scientific® simulator:

- simulates the haptic properties of real soft tissue when performing palpations and giving injections
- has a realistic vena saphena
- shows a tissue like texture and echogenicity on realistic ultrasound images

Training with this simulator enables students to:

- develop their abilities in ultrasound guided sclerotherapy
- recognise the different levels in order to be able to safely perform ultrasound guided sclerotherapy
- considerably improve their skilfulness and hand-eye coordination under optimal conditions
- internalise initial experience in order to be able to perform ultrasound-guided sclerotherapy more quickly, including on patients

The prototype of this simulator was successfully publicly tested for the first time during the scientific session of the 16TH INTERNATIONAL CONGRESS OF THE INTERNATIONAL UNION OF PHLEBOLOGY in Monaco from 31st August to 4th September 2009 [2] and won great approval among the professional audience.

9985-1012792

Literature:

[1] O'Hare A, Parkin D, Vandenbroeck CP, Earnshaw. Mid Term Results of Ultrasound guided Foam Sclerotherapy for Complicated and Uncomplicated Varicose Veins. *Eur J Vasc Endovasc Surg* 2008;36: 109-13

[2] Wulf J, Sica M, Cost-effective-training device for micro foam Ultrasound-Guided-Sclerotherapy [UGS] for varicose veins [Wissenschaftliches Poster]. 16. INTERNATIONALER KONGRESS DER UNION INTERNATIONALE DE PHLEBOLOGIE in Monaco, 31. AUGUST – 04. SEPTEMBER, 2009

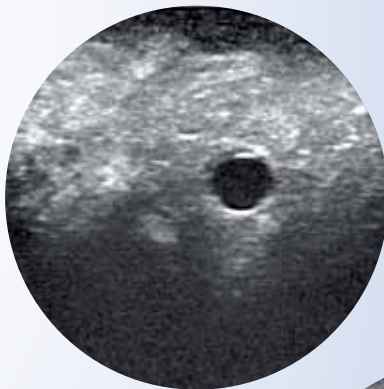

Ultrasound image of the simulated vessel viewed horizontally

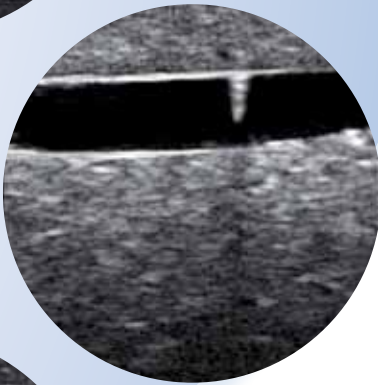

Ultrasound image of a needle point in the lumen of the simulated vessel, longitudinal presentation

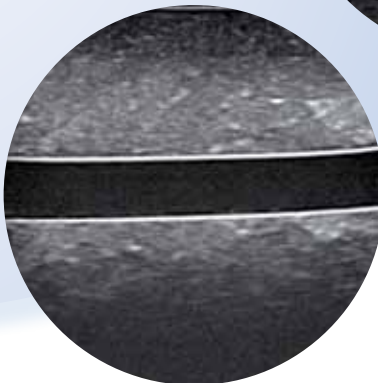

Ultrasound image of the simulated vessel viewed longitudinally

Intramuscular Injection Simulator

This low cost simulator enables you to practice intramuscular injections realistically with fluid up to a puncture depth of 50mm. The highly durable plastic skin can be pierced many hundreds of times and can easily be replaced if required. The container can be emptied quickly and easily after several uses and the foam can be squeezed to enable repetitions at any time.

9985-1010008



9985-1010008



Gastric Band Model

The model was developed based on our existing two-part stomach model to which was added an SAGB Quick Close® gastric band. A gastric band is inserted surgically to treat morbid obesity if conservative treatments are unsuccessful. This model is highly suitable as a tool for explaining the device to patients.

18x16x25 cm, 0.505 kg

L/E/D/S/F/P/I/J

9985-1012797



9985-1012787

Intestinal Diseases

This model shows the usual benign and malignant changes in the colon and rectum. These include diverticula, polyps, haemorrhoids, fistulae, fissures, chronic inflammatory diseases (Crohn's disease and ulcerative colitis), as well as intestinal cancer in various stages.

21x17x27 cm, 0.956 kg

L/E/D/S/F/P/I/J

9985-1008496



9985-1008496

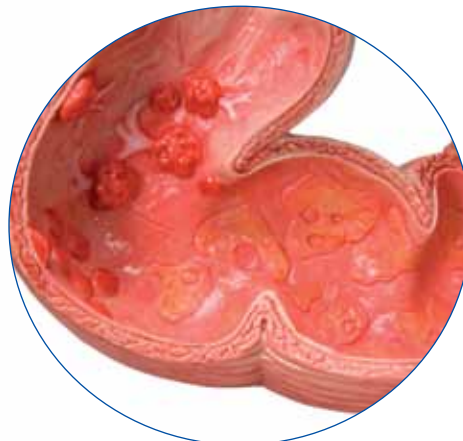

From Micro to Macro

Micro CT based anatomical teaching model by 3B Scientific

For the very first time, high resolution micro-computer tomography has been used to produce exact, enlarged replicas of very tiny structures from micro-anatomical original preparations, such as cancellous bone and human auditory ossicles.

This process supersedes the evaluation of two dimensional histological sections, so that the three dimensional micro-architecture of the scanned object can be reproduced in a non-destructive way.

Once developed to analyze small defects in ceramic materials, the micro CT scanner now has a valuable use in medicine, in particular in research into osteoporosis.

It works in a similar way to a traditional CT scanner, but has a much higher resolution and a longer scan time.

The data reconstructed on the computer during the scanning process has then been used to create this unique teaching model.



NEW
Unique Worldwide

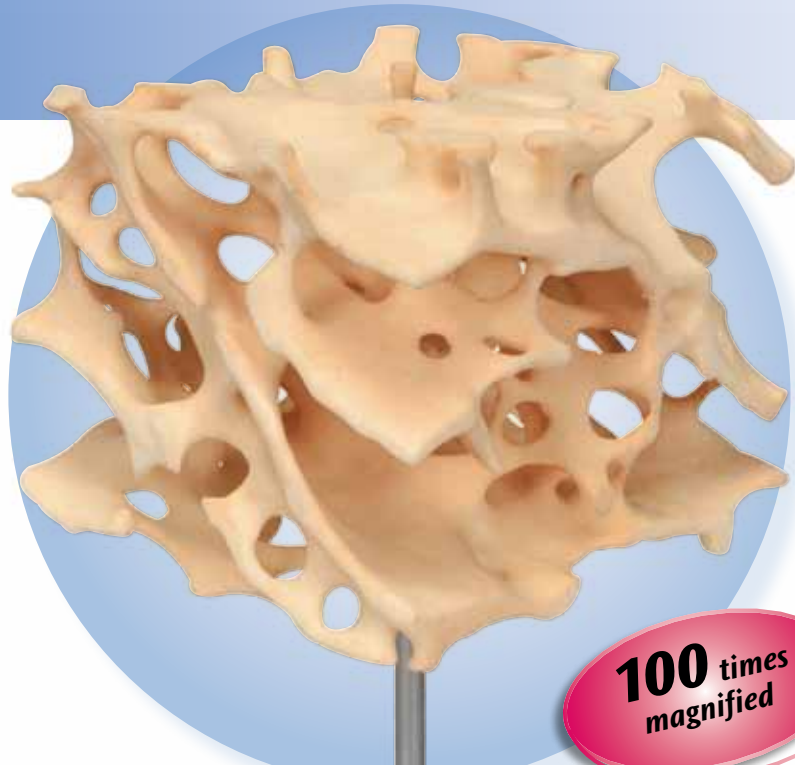

100 times magnified

9985-1009698

Original CT Images

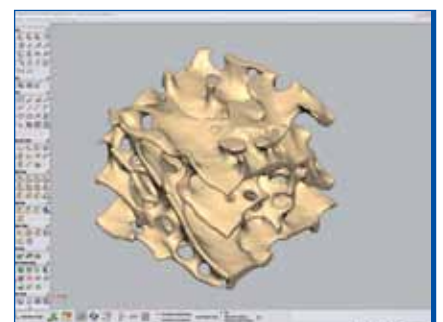
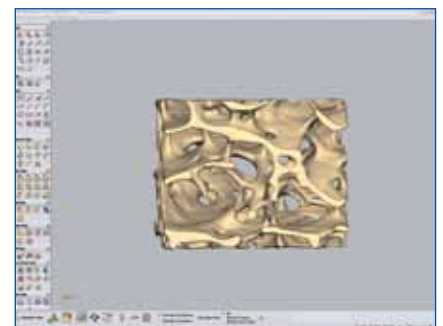
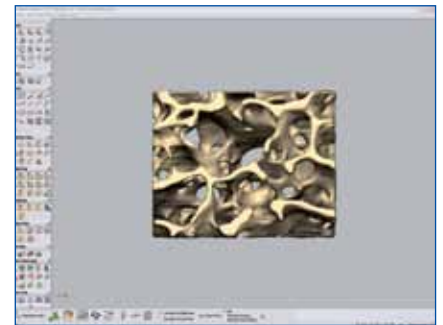

Cancellous Bone

The model shows the spongy bone inside the bone. Its filigree architecture is determined by influences such as pressure, bending and torsion. Using innovative micro CT technology, we have managed to reconstruct an exact three dimensional copy of a piece of cancellous bone from an original and enlarge it 100 times.

12x12x18, 0.238 kg

L/E/D/S/F/P/I/J

9985-1009698

NEW

Ossicles – magnified 20 times

With incomparable accuracy, this three dimensional model shows the human auditory ossicles in their normal state, magnified 20 times. This is possible using a micro-CT that works in a similar way to a large medical computer tomograph. Originals, just a few millimeters in size, of the malleus, incus and stapes were inserted into this device and scanned to produce virtually wafer-thin, high-resolution layers. They were then reproduced three-dimensionally using computer technology. In this way, the micro-architecture can be reproduced without damaging the structures. The result is a fascinating view of the smallest bones in the human body (stapes) and their companions (incus and malleus).

17x12x21 cm, 0.390 kg

L/E/D/S/F/P/I/J

9985-1019697

Ossicles – magnified 20 times BONElike™

17x12x21 cm, 0.285 kg

L/E/D/S/F/P/I/J

9985-1012786



NEW

Unique Worldwide

9985-1012786

Original CT Images

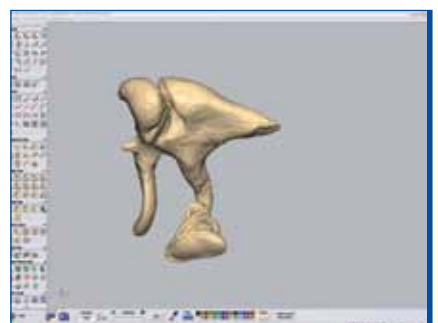
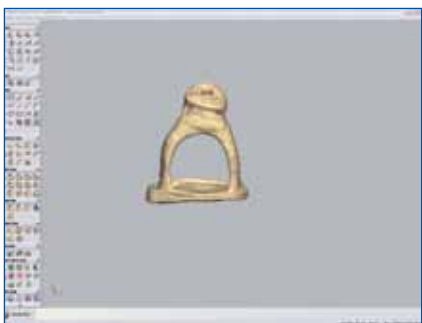
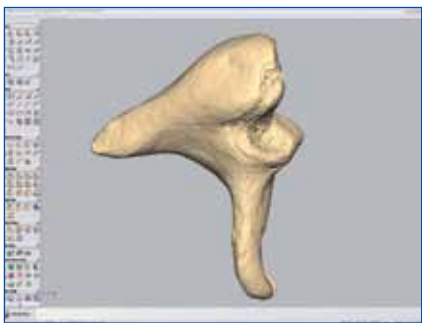

New Products

NEW



9985-1013059

9985-1013060

Infant Ostomy Trainer

The Infant Ostomy Trainer has been created to educate carers and parents on how to give special care to an infant with a stoma. This trainer will help by teaching step-by-step procedures for cleaning and caring for a baby's stoma and changing the pouching system. The anatomy of the colostomies were carefully reproduced to provide lifelike appearance and functions. A soft, pliable material is used for the stomas in order to achieve the most realistic tactile sensation. The syringes included are used to inject simulated stool through ports to the colostomy sites. Consistency of the simulated stool can be thinned by adding water. The colostomy sites can also be irrigated. The simulated stool may be reused. Trainer comes complete with one ostomy bag, a glove, two 3 cc syringes, 1 oz. jar of stool, 1 oz. jar of lubricant, wash bottle for irrigation, instruction manual, and a storage box.

9985-1013059

Infant Male and Female Catheterization Trainer

The Infant Male and Female Catheterization Trainer is an inexpensive 2-in-1 trainer that provides realistic practice of this difficult procedure.

- Practice insertion, position, catheter balloon inflation and deflation
- Feel resistance and pressure as with a real patient
- Urine flows when catheter is in proper position
- Practice both male and female infant catheterization training
- Anatomically realistic with both male and female genitals
- Genitals made of soft, lifelike material
- Replaceable male and female genitals
- Lower half of infant only

Includes: infant manikin, one male and one female genital insert, 2 oz. lubricant, infant Foley catheter, and instruction manual.

9985-1013060

Elderly Pressure Ulcer Foot

Chronic foot ulcers affect the elderly the most, we have designed the Elderly Pressure Ulcer Foot for instruction on care and cleaning of pressure ulcers in various stages. Pressure ulcers are more likely to appear over pressure points such as heels, tips of toes, between toes, or anywhere the bones may protrude and rub against socks, shoes, or bed sheets. This replica contains all four severity stages:

- Stage 1 – Located on the bottom of the toe. Surface of the skin is red.
- Stage 2 – Located on the bottom of the foot just under the toe. Surface of the skin is red and deeper into the skin layers.
- Stage 3 – Located on the side of the foot. Surface of the skin is red, looks more like a crater, and reaches the bottom layer of the skin.
- Stage 4 – Located on the heel of the foot. Surface of the skin is red. A great amount of tissue has been damaged, including muscle, bone, joints, and tendons. The Elderly Pressure Ulcer Foot includes a foot and information key card.

24x10 cm

9985-1013058



9985-1013058



9985-1013057

Diabetic Injection Pad

This pad looks and feels like human skin; ideal for diabetic instruction and injection practice. May be worn on the body in specific locations (stomach, thigh, upper arm) so patients can practice injections. Thick enough to accept all insulin needles. For safety purposes, there is a hard plastic backing to prevent the needle from poking through the pad and into the wearer's skin. 4-1/4" x 6-1/4" oval pad with hard plastic backing and 1" wide nylon strap with adjustable plastic buckle. Needles not included. 10x16 cm, 0.6kg

9985-1013057

Injection Belly

This soft stomach replica will be an invaluable tool for teaching patients how to properly insert and rotate the infusion set for insulin pumps, avoiding the 2" (5 cm) area around the navel, as well as giving self-injections. The replica has lifelike skin with what feels like real stomach tissue underneath. There is a soft plastic backing to keep needles from going through and holes to allow the material to breathe and dry, should you choose to inject liquids. Distilled water may be injected, but the more liquid that is injected into the simulator, the longer the time for evaporation. The injection belly is considered disposable, however, with proper care and treatment it will serve its purpose for a long period of time. Using the smallest needles possible when simulating injections and rotating the insertion points will help prolong the life of the replica. Infusion set and needle not included.

25x5x3 cm

9985-1013056



9985-1013056



9985-1012451



Training Arm for Implantable Hormonal Contraceptives

Representation of an upper left arm with soft foam insert to train insertion and removal of implantable hormonal contraceptives such as Levonorgestrel. Supplied with 10 tubular inserts and 1 extra skin. On base.

9985-1012451

COPD Model

COPD is a chronic lung disease with severe narrowing of the airways. Even administering medication cannot fully cure this narrowing. The model impressively shows the changes to the bronchial tissue (from bottom to top):

- normal condition
- abnormal mucous secretion, thickening of the bronchial mucosa
- permanent damage
- after administration of medication

15x11x8 cm, 0.181 kg

 L/E/D/S/F/P/I/J

9985-1012788



9985-1012788



9985-1012789

Head Section Model

The model shows a three dimensional section through the organ of Corti, the site of the sense of hearing in the inner ear in humans. Special attention has been given to the detailed representation of the individual cellular components and membranes. The overview model in the foreground also shows the exact location of the organ in the cochlea.

15x12x19 cm; 0.454 kg

 L/E/D/S/F/P/I/J

9985-1012789

Organ of Corti

The model shows a three dimensional section through the organ of Corti, the site of the sense of hearing in the inner ear in humans. Special attention has been given to the detailed representation of the individual cellular components and membranes. The overview model in the foreground also shows the exact location of the organ in the cochlea.

26x19x26 cm, 1.0 kg

 L/E/D/S/F/P/I/J

9985-1010005

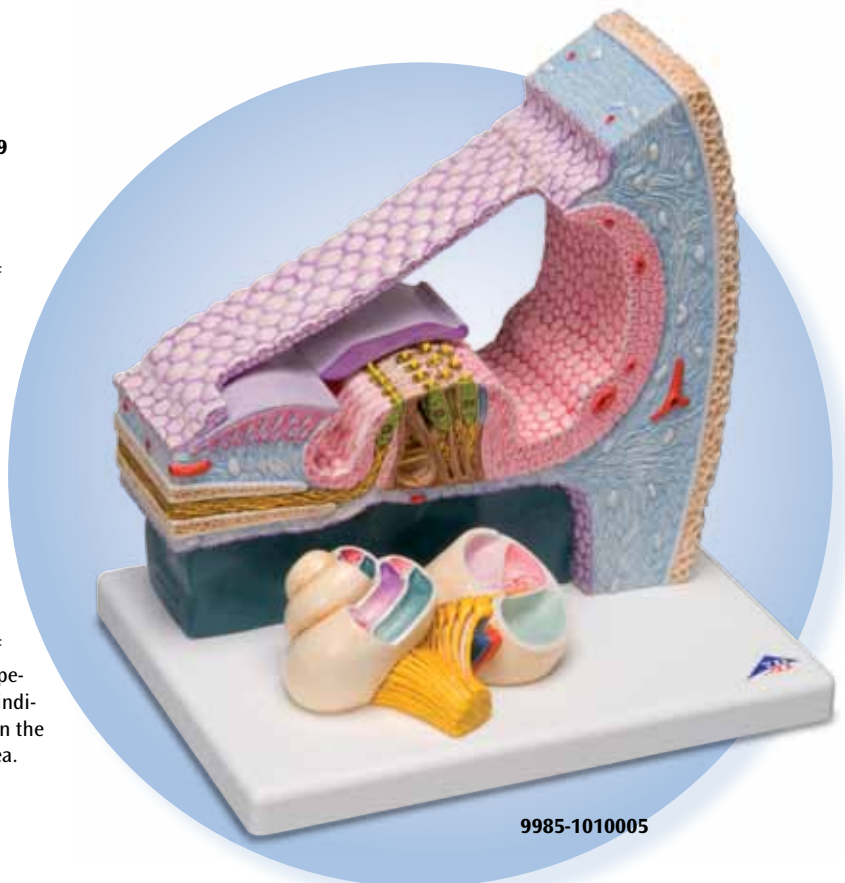

9985-1010005

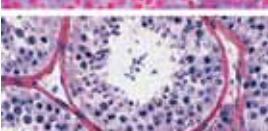
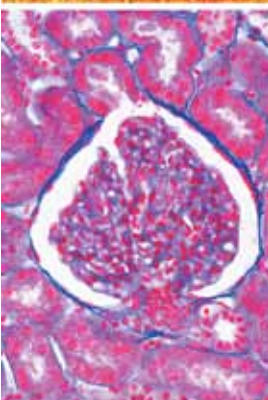
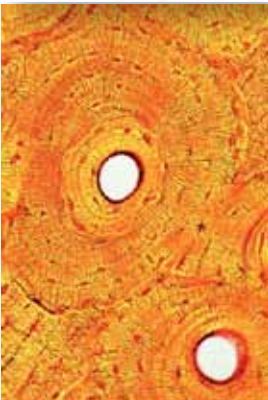
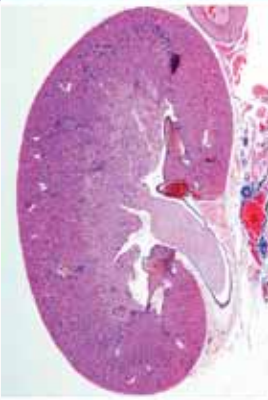
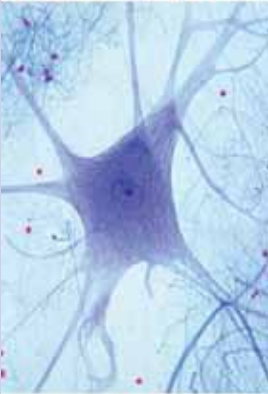
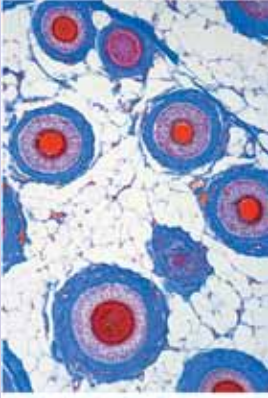

Prepared Microscope Slides "Made in Germany"

LIEDER Premium prepared MICROSCOPE SLIDES are made in our German laboratories under rigorous scientific control. They are the product of long experience combined with the most up to date techniques. The prerequisite for excellent preparations is good material, well preserved and fixed so that the finer structures are retained in as life-like a way as possible. Microtome sections are cut from this material by our highly skilled and experienced staff. They are of a thickness which will finally result in slides from which the maximum resolution of the structural components can be obtained. Particular attention is paid to the staining technique and in each case the selected method for a particular specimen will ensure the best possible differentiation combined with clear definition and permanency of staining. LIEDER prepared microscope slides are delivered on best glasses with fine ground edges of the size 26x76 mm (1x3") and are mailed in solid boxes. We reserve the right to make minor alterations to the sets and compilations.

All sets are furnished with illustrated explanatory brochures (manuals).

Further Details and
Information at
www.3bscientific.co.uk

Prepared microscope slides for histology and human science

60% of these preparations are of human origin, the other 40% are of animal origin (mainly rabbit, cat, rat, cow and pig).

Tissues

15 Microscope Slides

9985-1004237

Respiratory and Circulatory System

10 Microscope Slides

9985-1004238

Digestive System

11 Microscope Slides

9985-1004239

Urinary System

10 Microscope Slides

9985-1004240

Genital System

14 Microscope Slides

9985-1004241

Endocrine System

6 Microscope Slides

9985-1004242

Sensory Organs

10 Microscope Slides

9985-1004243

Nervous System

11 Microscope Slides

9985-1004244

Prepared microscope slide sets for pathology, bacteriology and parasitology

Human Pathology

Basic set
50 Microscope Slides

9985-1004236

General Parasitology

Short set
25 Microscope Slides

9985-1004266

Pathogenic Bacteria

25 Microscope Slides

9985-1004249

BESTSELLER

Histology

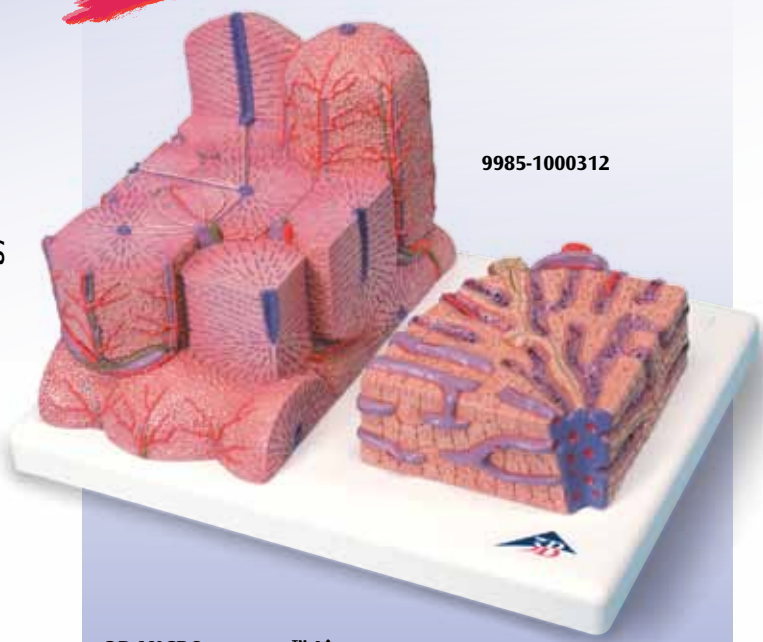

9985-1000312

3B MICROanatomy™ Liver

This 2-part model shows a highly magnified diagrammatic view of a section of the liver. The left part of the model shows a section of the liver that comprises several lobules. The right part of the model is a highly magnified view of the sectioned lobule on the left.

15x26x18.5 cm; 0.7 kg

L/E/D/S/F/P/I/J [www.](http://www.3bscientific.com)

9985-1000312

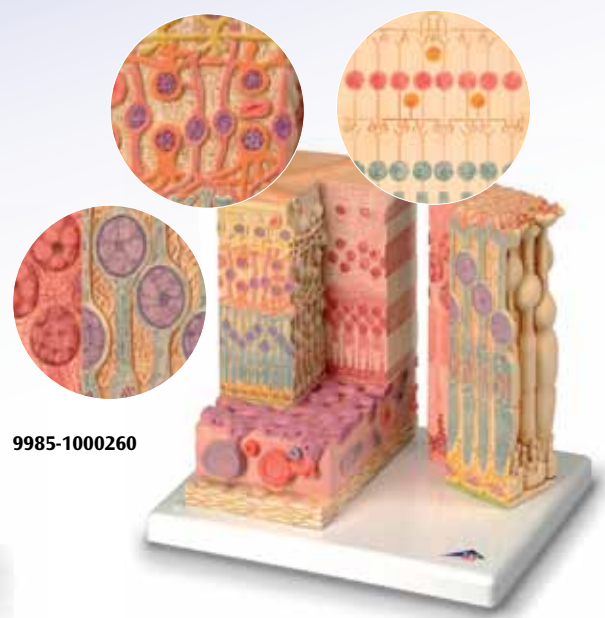

9985-1000260

3B MICROanatomy™ Eye

This model illustrates the microscopic structure of the retina with choroid and sclera. The left block like, layered side of the model side shows the complete structure of the retina including the vascular layer and parts of the sclera from a light microscopic view. The right part of the model is a sectional enlargement. It shows the microscopic structure of the photoreceptors and the cells of the pigmented layer.

25x23x18.5 cm; 1.2 kg

L/D/E/F/S/P/I/J [www.](http://www.3bscientific.com)

9985-1000260



9985-1000247

3B MICROanatomy™ Tongue

The latest model in our 3B MICROanatomy™ series, the tongue, is fascinating because it combines enlargements of various different parts of the tongue in one model. It comprises a macroscopic view of the tongue in life size (dorsal view) and microscopic views of the various papillae of the tongue (10-20x life size) and of a taste bud (approx. 450x life size). All views are mounted on a base that also features an overview of the sensory and sensitive innervation of the tongue. A unique model for an intensive study of the tongue.

14.5x32.5x20 cm, 0.8 kg

L/D/E/F/I/S/P/J/R/C [www.](http://www.3bscientific.com)

9985-1000247



9985-1000311

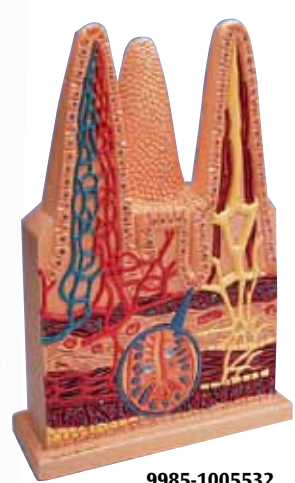

9985-1005532

3B MICROanatomy™ Digestive System

The model illustrates the structure of the fine tissues of four characteristic sections of the digestive system: oesophagus, stomach, small intestine, large intestine. The front of the model, from top to bottom, shows a magnified view in histological section of the individual sections of the digestive system and their fine tissue structures. On the back of the model, highly magnified views of didactically interesting areas of each of the digestive system sections shown on the front are emphasized.

29.5x26x18.5 cm; 1.5 kg

L/E/D/S/F/P/I/J [www.](http://www.3bscientific.com)

9985-1000311

Intestinal Villi, 100 times life-size

This model consists of one entire villus, one longitudinally sectioned villus showing the arterioles and venules and one sectioned villus to show the lymphatic vessels. Also includes a longitudinal section of Lieberkühn's crypt. On base.

43x28x10 cm; 2.5 kg

9985-1005532

Anatomy



9985-1000301

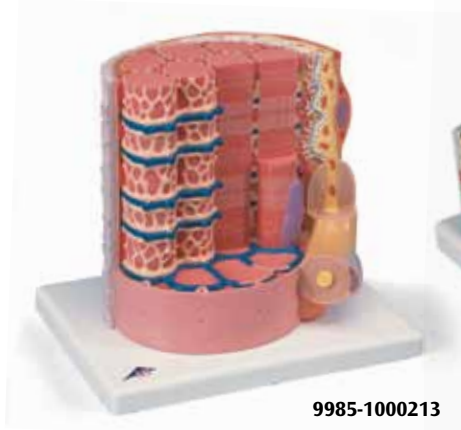

9985-1000213

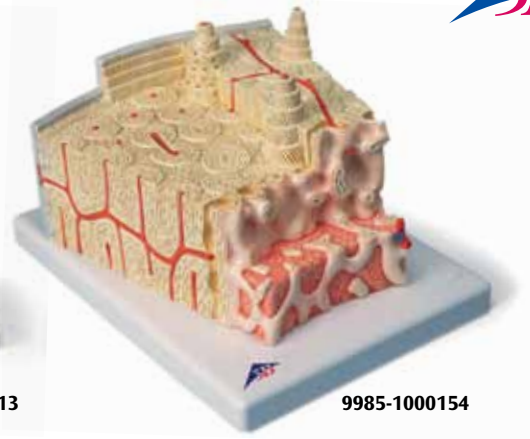

9985-1000154

3B MICROanatomy™ Kidney

This extremely detailed model shows the morphologic / functional units of the kidney greatly magnified. Six model zones illustrate the following fine-tissue structures that serve the production of urine:

- Longitudinal section of a kidney
- Section of renal cortex and renal medulla
- Wedge-shaped section of a kidney lobe with a diagrammatic depiction of three nephrons with Henle's loops of different lengths and diagrammatic depiction of the vascular supply
- Diagrammatic illustration of a nephron with a short Henle's loop and didactic / diagrammatic illustration of the vascular supply
- Diagrammatic illustration of an opened renal corpuscle with nephron and light-microscopic transverse sections of the proximal, attenuated and distal segments of a renal tubule
- Diagrammatic / didactic illustration of an opened renal corpuscle

Mounted on a base.

23.5x25.5x19 cm; 1.3 kg

L/E/D/S/F/P/I/J [www.](http://www.3b.com)

9985-1000301

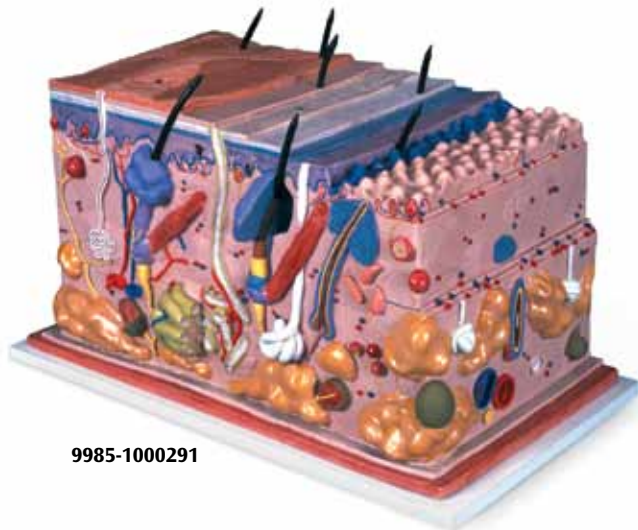

9985-1000291

Skin, Block Model, 70 times full-size

This unique model shows a section of human skin in three dimensional form. Individual skin layers are differentiated, and important structures such as hair, sebaceous and sweat glands, receptors, nerves and vessels are shown in detail. Mounted on baseboard.

44x24x23 cm; 3.6 kg

L/E/D/S/F/P/I/J [www.](http://www.3b.com)

9985-1000291



9985-1000289

3B MICROanatomy™ Bone Structure

This extremely detailed model depicts a three-dimensional section of a lamellar bone, showing the typical structure of a tubular bone enlarged 80 times. Various planes are shown in cross and longitudinal section through all levels of the bone, as well as a 2-plane section through the inner structure of the bone marrow. The typical elements of a lamellar bone are easily identified and help to understand its structure and function with the characteristic osteons, also referred to as Haversian systems. This model allows a graphic illustration of the interplay of the individual components, such as spongy and compact substance, endosteum, cortical substance, osteocytes, Volkmann and Haversian canals.

Supplied on base.

26x19x14.5 cm; 0.8 kg

E/D/S/F/P/J [www.](http://www.3b.com)

9985-1000154

3B MICROanatomy™ Muscle Fibre

The model illustrates a section of a skeletal muscle fibre and its neuromuscular end plate magnified approx. 10.000 times. The muscle fibre is the basic element of the diagonally striped skeletal muscle.

23.5x26x18.5 cm; 1.1 kg

L/E/D/S/F/P/I/J

9985-1000213

9985-1000290

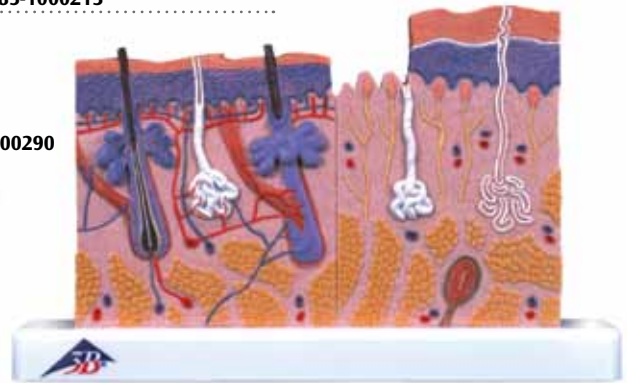

Skin Section, 70 times full-size

This relief model shows a section through the three layers of the hair-covered skin of the head. Delivered on base it shows:

- Representation of hair follicles with sebaceous glands
- Sweat glands
- Receptors
- Nerves
- Vessels

26x33x5 cm; 1.0 kg

L/E/D/S/F/P/I/J [www.](http://www.3b.com)

9985-1000289

Skin Section, 40 times full-size

The two halves of this relief model show the three layers of hairy and hairless skin in order to make the differences clear. In detail with hair follicles, sebaceous glands, sweat glands, receptor, nerves and vessels. Delivered on base.

24x15x3.5 cm; 0.2 kg

L/E/D/S/F/P/I/J [www.](http://www.3b.com)

9985-1000290

3B Scientific® Skeletons – Value for Money

When choosing a skeleton model, you are bound to find considerable differences with regard to quality and price. A cheap skeleton may seem appealing to your budget, but does it also offer you reliable quality and attention to anatomical detail? Is it free of chemicals to ensure that you and your pupils, students, staff or patients are not subjected to any hazardous substances? Will it serve you well for many, many years or will you need to buy a replacement after only a few months?

Before making your purchase decision, please consider the following points:

- All 200+ bones are represented, even the hyoid and the styloid process
- A natural cast with true to original surface structure
- The arms and legs can be easily removed and reattached
- The skull can be disassembled and reassembled with ease
- Includes all subcranial openings
- The eye sockets are naturally shaped and the optic canal is portrayed
- The cartilage of the ribcage is hard wearing and robust
- The ribcage is assembled robustly and will not collapse in itself
- The materials used are high quality and durable
- All metal parts are made of stainless steel
- The model is safe and toxicologically harmless

Our range of true-to-original 3B Scientific® skeletons made of unbreakable plastic fulfils all of these demands. We grant you a three year warranty for that and the promise that every one of our skeletons is a high quality product with an outstanding price performance ratio. 3B Scientific not only promises quality on paper, but has made it the measure of all actions – ISO 9001:2008 certified and tested by independent auditors.

Classic Skeleton Stan, on 5-foot Roller Stand

This classic model (we call him Stan) has been the standard of quality in hospitals, schools, universities, and laboratories for over 50 years. Choose from 5 models to suit your individual preference – of course each one has all standard benefits of a 3B Scientific® skeleton.

170 cm; 7.6 kg

9985-1000010

BESTSELLER

Classic Skeleton Stan, on Hanging 5-foot Roller Stand with Brake

186 cm; 8.3 kg

9985-1000028



Detail of 9985-1000028

9985-1000010

All 5-leg roller stands have brakes

The Standard Benefits of a 3B Scientific® Skeleton:

- Excellent value for money
- 3-year warranty
- First-class natural cast “Made in Germany”
- Manual final assembly
- Made of durable, unbreakable plastic
- Almost natural weight for the approx. 200 bones
- Life-size
- 3-part mounted skull
- Limbs are quick and easy to remove
- Stand and transparent dust cover included
- All 5-leg roller stands have brakes

Details of the additional features of each individual model is provided in the product descriptions.



All 5-leg roller stands have brakes

9985-1000029

Classic Skeleton Max, on 5-foot Roller Stand with Brake

This version contains all standard benefits of a 3B Scientific® skeleton but additionally offers representations of the structural interaction between bones and muscles. It depicts over 600 structures of medical / anatomical significance including muscle origins (red) and insertions (blue) on the left side as well as hand-numbered bones, fissures and foramina on the right side.

170 cm; 8.0 kg

L/E www.3bscientific.com

9985-1000029

Classic Skeleton Leo, on 5-foot Roller Stand with Brake

In addition to the standard benefits of a 3B Scientific® skeleton, Leo provides representations of the structural interaction between bones and ligaments. Its elastic ligaments on the major appendicular joints (shoulder, elbow, hip and knee) are mounted on the right side.

170 cm; 8.2 kg

9985-1000031

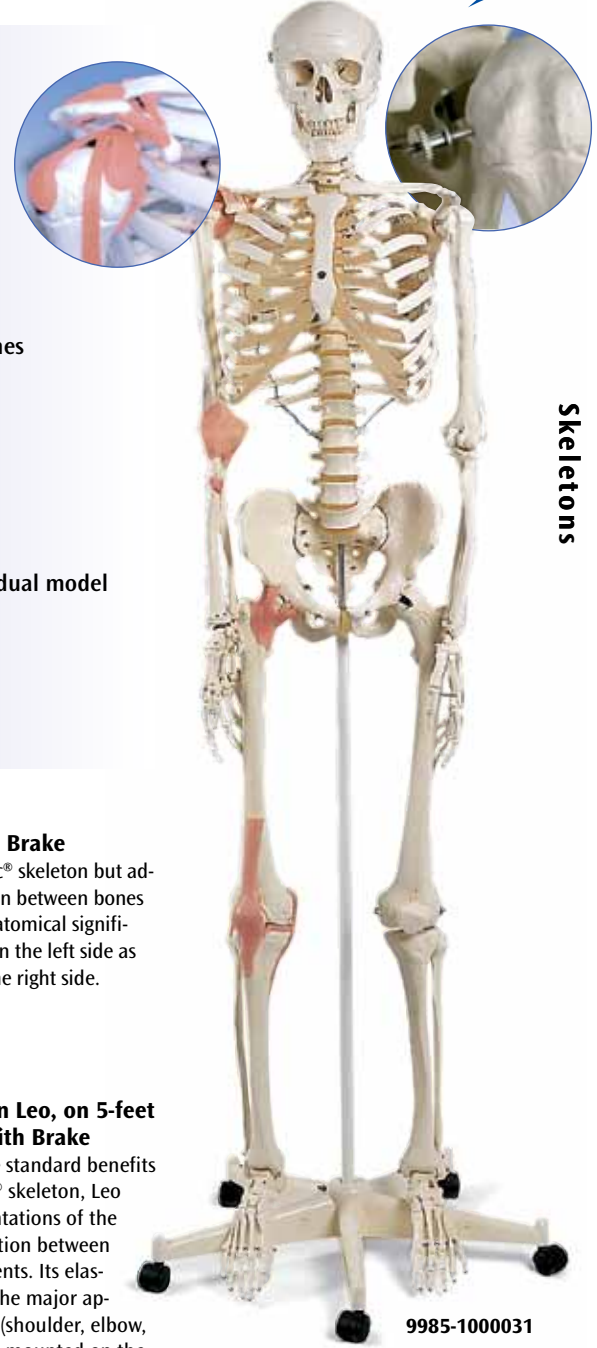

9985-1000031

You will find our large selection of Charts starting on page 108.

Classic Skeleton Max Showing Muscles, on Hanging Stand with Brake

186 cm; 8.3 kg

L

9985-1000030

9985-1000030



Heavy Duty Dust Cover for Skeletons

Protect your investment with our heavy duty protective cover. Suitable for all skeletons and stand versions. Black with transparent window.

9985-1005468

9985-1005468



9985-4006732
9985-1001630

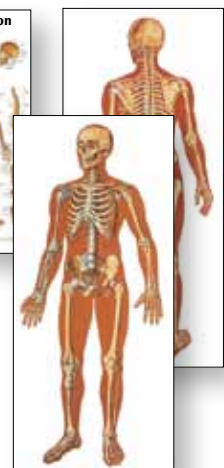

9985-4006512 – 9985-4006513 –
9985-1001146 + 9985-1000012 +

BESTSELLER

Skeletons

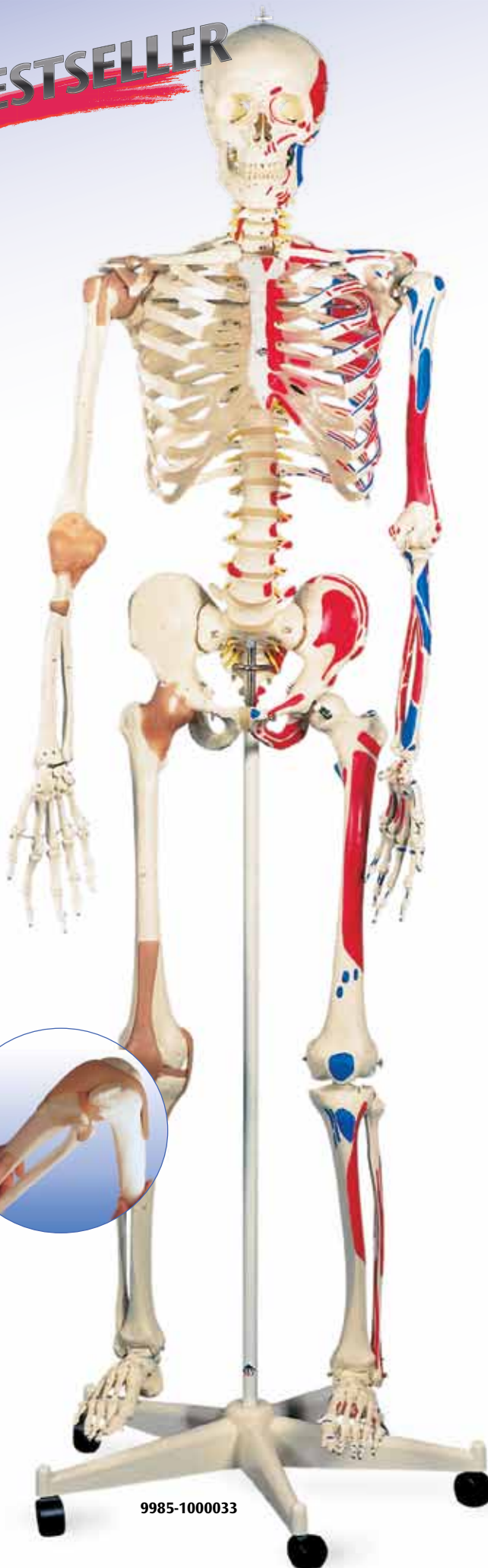

9985-100033



Sam Deluxe Skeleton, on 5-foot roller stand with brake

Of course this top-of-the-range version contains all the benefits you have come to expect in our high quality 3B Scientific® standard skeletons. Sam additionally allows you to demonstrate the movements of the skull and head joints as well as all natural human postures due to the fully flexible vertebral column. The unique combination of flexible vertebral column, muscle origins and insertions, numbered bones, flexible joint ligaments and a disc prolapse between the 3rd and 4th lumbar vertebrae display over 600 structures of medical /anatomical interest in this top model.

To sum it up:

- All standard benefits of a 3B Scientific® Skeleton (see page 17)
- Over 600 hand-numbered and identified details
- Hand-painted muscle origins and insertions
- Flexible joint ligaments
- Flexible vertebral column
- Emerging spinal nerves and vertebral arteries
- Disc prolapse between L3 and L4

170 cm; 8.2 kg

L/E [www.](http://www.3bscientific.com)

9985-100033

Sam Deluxe Skeleton, on hanging stand with brake

186 cm; 8.5 kg

L/E [www.](http://www.3bscientific.com)

9985-100034

Anatomy

Fred Deluxe Skeleton, on 5-foot roller stand with brake

Introducing Fred the flexible skeleton. Fred's spine can bend to mimic any natural human movement. Once flexed, it will remain fixed in position to demonstrate correct and incorrect posture or various pathological conditions. In addition, all skull and neck movements can be demonstrated. Spinal nerve exits and vertebral arteries are shown as is a dorso-lateral disc prolapse between the 3rd and 4th lumbar vertebrae. Of course Fred also provides all standard benefits of a 3B Scientific® skeleton (see page 17). 170 cm; 8.0 kg

9985-1000035

Fred Deluxe Skeleton (1 hand and 1 foot flexible), on 5-foot roller stand with brake (not shown)

Same as 9985-1000035, in addition 1 hand and 1 foot are flexibly mounted.

9985-1000036

Physiological Skeleton Phil, on hanging roller stand with brake

This skeleton is unique in its nearly life like representation of the joint mechanisms. It allows you to demonstrate the inward and outward rotation of the arms and legs and the extension and flexion of the knee and elbow joints. The flexible spine allows for natural movement (lateral inclination, movement and extension, rotation). The bones of the hands are mounted on wire to demonstrate their natural positions. The foot bones are mounted flexibly to enable movement. The shoulder blades rotate when the arms are raised. Even the restricted mobility of the iliosacral joint and the sacrococcygeal joint can be demonstrated. Of course Phil has all the standard benefits of a 3B Scientific® skeleton

186 cm; 8.5 kg

E/D/S/F/P/J [www.](http://www.3bscientific.com)

9985-1000037

Functional Skeleton Model "Frank", flexible, on hanging roller stand with brake

As 9985-1000037, however with all large joints flexibly mounted. Developed with the assistance of John Chester M.D. (advisor to the Feldenkrais Guild N.A.), this unique model allows you to perform individual movements in a nearly lifelike way. You can even demonstrate the complex motions of the upper extremity with this functional human skeleton. A great help in clearly demonstrating the Feldenkrais methods!

9985-1000038

Physical Therapy Skeleton

- Removable skullcap for studies of the internal skull base
- Breakaway maxilla revealing paranasal sinuses
- Spring mounted, detachable mandible
- Skeleton disarticulates into 8 pieces (both arms and legs, 4-part skull)
- Hand-painted and hand lettered muscle origins (red) and insertions (blue)
- Left hip removable
- With brachial plexus
- Flexible vertebral column
- One knee demonstrates "bucket handle" deformity
- Muscles of mastication for TMJ demonstration
- Normal heart and lobar lung
- Supplied with deluxe stand

172 cm; 11.5 kg

E

9985-1005859

Orthopaedic Skeleton

(not shown)

As 9985-1005859, but not including the masticatory muscles, heart and lung.

172 cm, 9.0 kg

9985-1005858

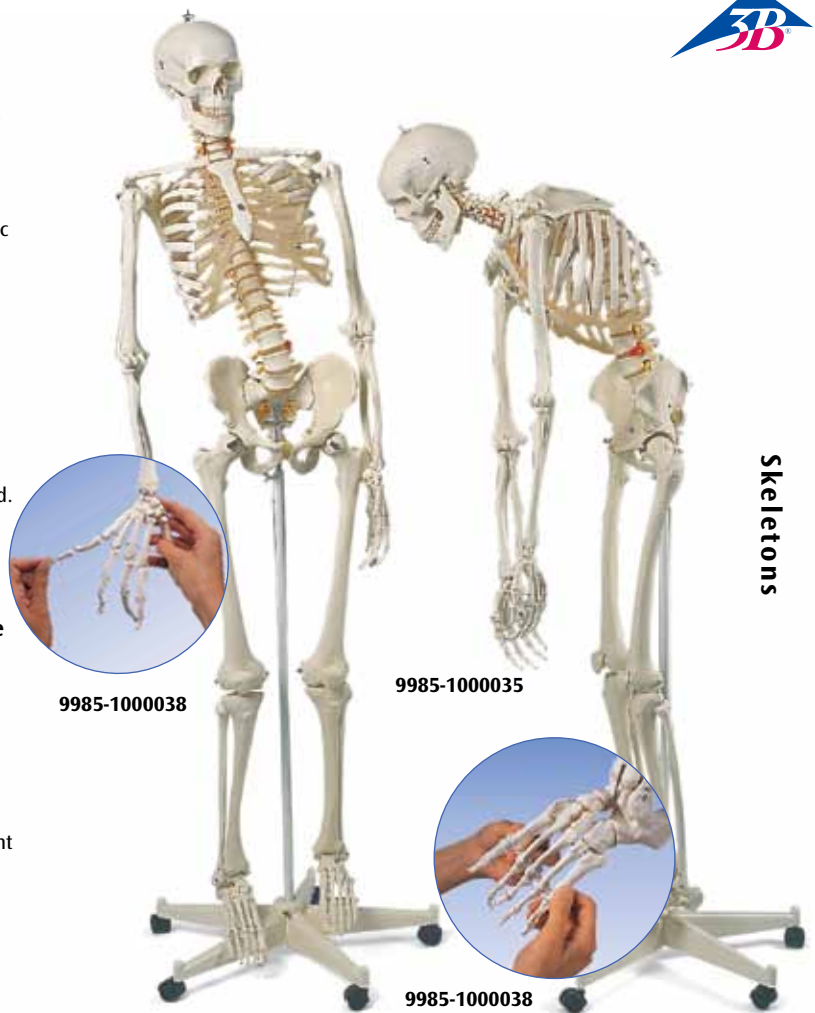

Skeletons

FELDENKRAIS

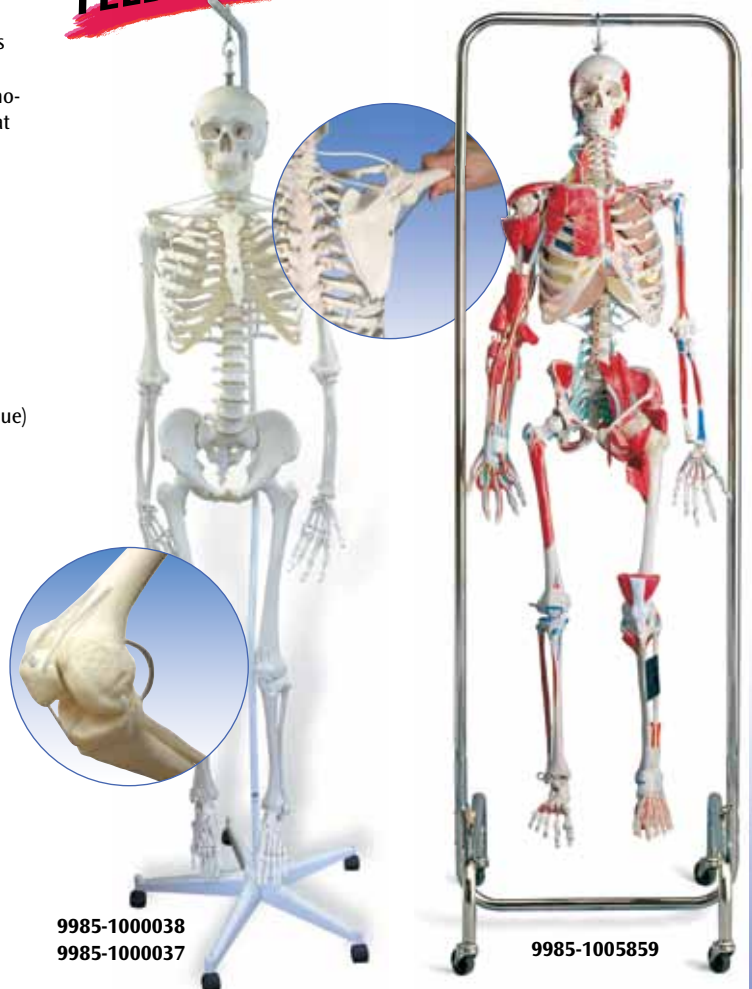

Anatomy



9985-1000039

Mini Skeleton “Shorty”, mounted on a base

Top of the range mini skeleton. Skillful 3B engineers using powerful hardware and software optimized the process of reproducing miniatures in order to keep all anatomical details and structures even at half natural size (80 cm). The skull can be removed and disassembled into three parts (skull-cap, base of skull, mandible) and the arms and legs are removable. The hip joints are specially mounted so their natural rotation can be demonstrated. 88 cm; 1.5 kg

9985-1000039

Mini Skeleton “Shorty”, on hanging stand (not shown)

This model is the same as the 9985-1000039 Mini Skeleton, but with a hanging stand. The stand can be either placed on the floor or attached to a wall.

94 cm; 1.7 kg

9985-1000040



9985-1000045

Mini Skeleton “Shorty” with Painted Muscles, on base (not shown)

As 9985-1000039, but with coloured portrayal of the muscle origins (red) and insertions (blue) on the left half. The muscles are numbered.

L/D/E/F/I/S/P/J www.

9985-1000044

Mini Skeleton “Shorty” with Painted Muscles, on hanging stand

As 9985-1000044, but with hanging stand.

The stand can be either placed on the floor or be suspended from the wall.

94 cm; 1.7 kg

L/D/E/F/I/S/P/J www.

9985-1000045

Desktop Skeleton

This model shows the basic bony locomotive apparatus and, in addition, the emerging spinal nerves, vertebral arteries and one prolapsed disc. Arms and legs mounted flexibly. Supplied with a stand. 84 cm; 2.7 kg

9985-1005457



9985-1005457

Disarticulated Half Skeleton

Complete with mounted skull, sternum, hyoid and spinal column. Hand and foot on wire. Supplied in a sturdy partitioned storage box. 49x43x26.5 cm; 4 kg

9985-1000023



Disarticulated Half Skeleton, with loosely articulated hand and foot (not shown)

Complete with mounted skull, sternum, hyoid and spinal column. Hand and foot loosely articulated on nylon cord. Supplied in a sturdy partitioned storage box. 48.5x27x42.5 cm; 4 kg

9985-1000024



Sternum with Rib Cartilage (not shown)

9985-1000136

Ribs, 12 of one side (not shown)

9985-1000137

Disarticulated Full Skeleton, with 3 part skull (not shown)

One hand and foot on wire, one loosely articulated. Supplied in a sturdy partitioned storage box. 48.5x27x42.5 cm; 4.8 kg

9985-1000025



Disarticulated Painted Full Skeleton, showing muscles with 3-part skull

This special version is hand painted and numbered to show muscle origins in red and muscle insertions in blue on the left side. All bones and bony structures such as fissures, foramina and processes are hand numbered on the right side. The skull separates into 3 parts. One hand and foot on wire, one set of arms and leg loosely. Comes with a multilingual product manual to identify over 600 numbered anatomical structures. Supplied in a sturdy partitioned storage box. 48.5x27x42.5 cm; 6 kg

L/E www.3b.com

9985-1000026

9985-1000026

Intervertebral Discs on Nylon, 23 pieces (not shown)

All human cartilaginous discs loosely threaded on nylon in their correct sequence.

9985-1000027

Hyoid bone on stand

9985-1000143

9985-1000143



3B MICROanatomy™ Bone Structure

This extremely detailed model depicts a three dimensional section of a lamellar bone, showing the typical structure of a tubular bone enlarged 80 times. Various planes are shown in cross and longitudinal section through all levels of the bone, as well as a 2-plane section through the inner structure of the bone marrow. The typical elements of a lamellar bone are easily identified and help to understand its structure and function with the characteristic osteons, also referred to as Haversian systems. This model gives a clear illustration of the interplay of the individual components, such as spongy and compact substance, endosteum, cortical substance, osteocytes, Volkmann and Haversian canals. Supplied on base. 26x19x14.5 cm; 0.8 kg

E/D/S/F/P/J www.3b.com

9985-1000154

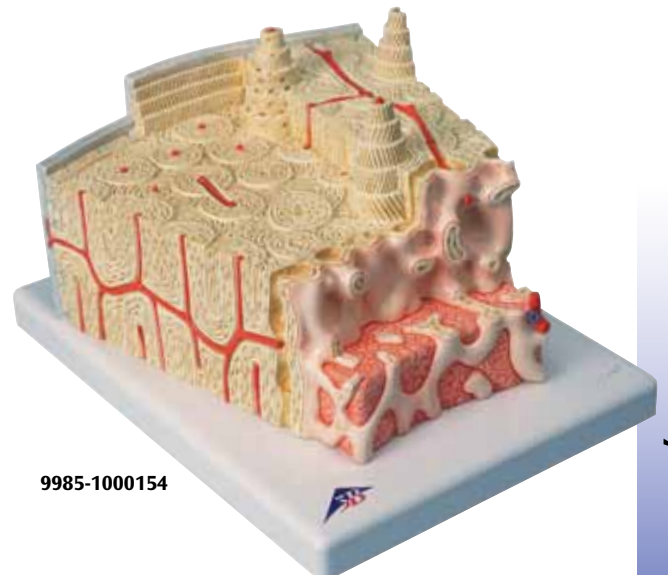

9985-1000154

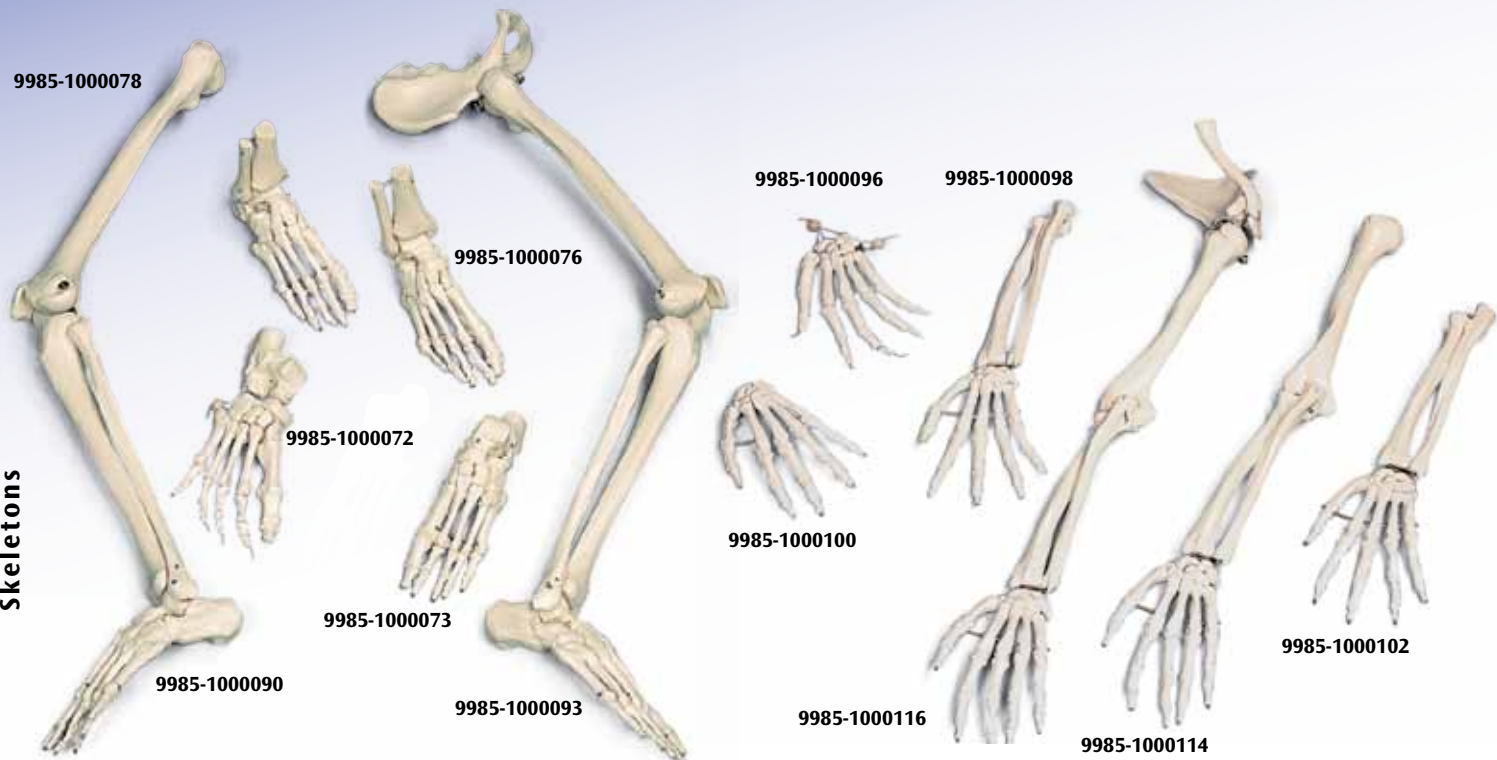

Art. No.	Skeleton Components	Art. No.	Skeleton Components
9985-1000073	Foot Skeleton mounted on wire, left	9985-1000100	Hand Skeleton wire mounted, left
9985-1000074	Foot Skeleton mounted on wire, right	9985-1000101	Hand Skeleton wire mounted, right
9985-1000071	Foot Skeleton loosely threaded on nylon, left	9985-1000096	Hand Skeleton loosely threaded on nylon, left
9985-1000072	Foot Skeleton loosely threaded on nylon, right	9985-1000097	Hand Skeleton loosely threaded on nylon, right
9985-1000077	Foot Skeleton with portions of tibia and fibula, wire mounted, left	9985-1000098	Hand Skeleton with portions of ulna and radius, flexibly mounted, left
9985-1000078	Foot Skeleton with portions of tibia and fibula, wire mounted, right	9985-1000099	Hand Skeleton with portions of ulna and radius, flexibly mounted, right
9985-1000075	Foot Skeleton with portions of tibia and fibula, flexibly mounted, left	9985-1000102	Hand Skeleton with portions of ulna and radius, wire mounted, left
9985-1000076	Foot Skeleton with portions of tibia and fibula, flexibly mounted, right	9985-1000103	Hand Skeleton with portions of ulna and radius, wire mounted, right
9985-1000090	Leg Skeleton, left	9985-1000114	Arm Skeleton, left
9985-1000091	Leg Skeleton, right	9985-1000115	Arm Skeleton, right
9985-1000079	Femur, left	9985-1000104	Humerus, left
9985-1000080	Femur, right	9985-1000105	Humerus, right
9985-1000081	Patella, left	9985-1000106	Ulna, left
9985-1000082	Patella, right	9985-1000107	Ulna, right
9985-1000083	Tibia, left	9985-1000108	Radius, left
9985-1000084	Tibia, right	9985-1000109	Radius, right
9985-1000085	Fibula, left	9985-1000110	Scapula, left
9985-1000086	Fibula, right	9985-1000111	Scapula, right
9985-1000087	Hip Bone, left	9985-1000112	Clavicle, left
9985-1000088	Hip Bone, right	9985-1000113	Clavicle, right
9985-1000089	Femur Heads, 1 pair	9985-1000116	Arm Skeleton with scapula and clavicle, left
9985-1000092	Leg Skeleton with Hip Bone, left	9985-1000117	Arm Skeleton with scapula and clavicle, right
9985-1000093	Leg Skeleton with Hip Bone, right		

Hand Skeleton Model with Ligaments and Muscles

The bones, muscles, tendons, ligaments, nerves, arteries, and veins are all featured in this high quality 4 part model of the hand and lower forearm. The dorsal side shows the extensor muscles as well as portions of the tendons at the wrist as they pass under the extensor retinaculum. The palmar face of the hand is represented in three layers, the first two removable to allow detailed study of the deeper anatomical layer. In addition clinically important structures such as the median nerve and superficial palmar arterial arch can be examined in detail. The deepest anatomical layer allows for study of the intrinsic muscles and deep palmar arterial arch in addition to other details.

33x12x12 cm, 0,4 kg

L/D/E/F/I/S/P/J/R/C [www.](http://www.3b.com)

9985-1000358

Hand Skeleton Model with Ligaments and Carpal Tunnel

This 3 part hand model shows the anatomical details of the ligaments and tendons found in the hand, wrist, and lower forearm. The interosseous membrane between the radius and ulna is shown along with the bones of the hand. The flexor retinaculum is removable and in addition there is a removable portion that can be fitted onto the back of the model. This portion features the clinically important structures of the carpal tunnel such as the flexor retinaculum, median nerve, and tendons.

30x14x10 cm, 0,3 kg

L/D/E/F/I/S/P/J/R/C [www.](http://www.3b.com)

9985-1000357

Internal Hand Structure Model, 3-part

Full size hand model showing the superficial and internal structures of the hand, including bones, muscle, tendons, ligaments, nerves, and arteries (superficial and deep palmar arches). The palmar aponeurosis and plate of the superficial tendons are removable.

28.5x13x6.5 cm; 1.2 kg

L/D/E/S/F/P/I/J [www.](http://www.3b.com)

9985-1000349

Internal Finger Structure Model

This full size model shows the bones, muscles and tendons of the human index finger. Supplied on stand.

19.5x13x19 cm; 0.5 kg

L/D/E/S/F/P/I/J [www.](http://www.3b.com)

9985-1000350

Deluxe Hand and Wrist

- Cast from natural bone specimen
- Articulated bones of hand and wrist
- Interosseous muscles depicted
- Shows median, ulnar and radial nerve
- Tendons, ligaments and arteries simulated
- Palmar and thenar space simulated
- Transverse ligament can be cut to show carpal tunnel syndrome
- Stand included.

6x18x18 cm; 0.3 kg

E

9985-1002388

Deluxe Foot and Ankle

- Cast from natural bone specimen
- Bones of foot and ankle
- Lower half of tibia and fibula
- Depicts all major muscles, nerves, arteries and tendons
- Stand included.

22x18x18 cm; 0.5 kg

E

9985-1002391





9985-1000359

Foot Skeleton Model with Ligaments

This detailed model displays numerous important ligaments and tendons including the achilles and peroneus longus tendons of the ankle. The model consists of the bones of the foot and lower portions of the tibia and fibula, including the introsseous membrane found between them. All the anatomically important ligaments and tendons are shown.

23x18x30 cm, 0.6 kg
 L/D/E/F/I/S/P/J/R/C www.

9985-1000359

Foot Skeleton Model with Ligaments and Muscles

This model is the best of its kind for quality and value. This anatomically detailed model of the foot and lower leg can be disassembled into 6 removable parts for detailed study. The model features not only the bones but also muscles, tendons, ligaments, nerves, arteries, and veins. The frontal view features the extensor muscles of the lower leg. The tendons can be followed on their passage under the transverse and crucial crural ligaments all the way to their insertion points. In addition all tendon sheaths are visible. On the dorsal portion of the model the gastrocnemius muscle is removable to reveal deeper anatomical elements. The sole of the foot is represented in three layers; the first layer displaying the flexor digitorum brevis. This muscle can be removed revealing the quadratus plantae, the tendon of the flexor digitorum longus, and the flexor hallucis muscle. This second layer is in turn removable to display even deeper anatomical details.

23x26x19 cm, 1.1kg
 L/D/E/F/I/S/P/J/R/C www.

9985-1000360



9985-1000360

Normal Foot

Superficial structures as well as internal bones, muscles, ligaments and nerves are represented.

13x24x9 cm; 0.4 kg
 L/D/E/F

9985-1000354

Flat Foot (Pes Planus)

Superficial structures as well as internal bones, muscles, ligaments and nerves are represented.

12x24x10 cm; 0.4 kg
 L/D/E/F

9985-1000355

Hollow Foot (Pes Cavus)

Superficial structures as well as internal bones, muscles, ligaments and nerves are represented.

13x23x10 cm; 0.4 kg
 L/D/E/F

9985-1000356



9985-4006659
 9985-1001484

9985-4006662
 9985-1001490

You will find our large selection of Charts starting on page 108.



9985-1000356

9985-1000354

9985-1000355

Diversity of 3B Scientific® Skulls

Take advantage of the largest selection of human skull models. Whether it's the world's best-selling, our inexpensive classic skulls, the Beauchene skull or our incredibly realistic BONElike™ skulls, on the following pages you will surely discover the model you've always wanted. Let your requirements decide for you – you'll find what you're looking for here!



9985-1000046

Classic Skull, 3-part

Our Classic Skulls combine quality and value. Each of the 8 classic versions available are designed to show exceptional detail at an affordable price. The 3-part standard version A20 is a first choice for basic anatomical studies or an attractive present. Alternatively, choose one of the more advanced versions exhibiting additional anatomical structures such as muscle origins/insertions, hand-numbered bones and structures or a supplementary complete 5-part brain.

20x13.5x15.5 cm; 0.6 kg

9985-1000046



9985-1000051

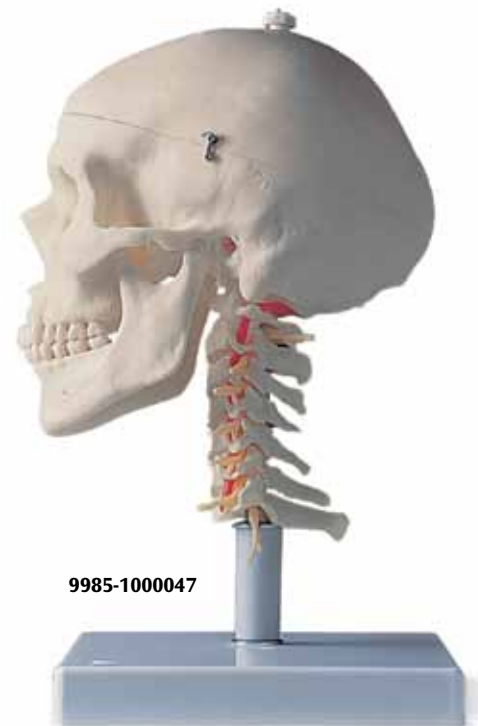

9985-1000047

Skull on Cervical Spine, 4-part

This flexibly mounted version on a stand with a cervical spine. Also represented are the hindbrain, spinal cord, cervical nerves, vertebral arteries, basilar artery and rear cerebral arteries. On stand.

20x13.5x15.5 cm; 1.4 kg

9985-1000047

Classic Skull, transparent, 3-part

Use this unique skull to study internal structures that are otherwise only visible using x-ray images.

20x13.5x15.5 cm; 0.6 kg

9985-1000051



9985-1000055



9985-1000054



9985-1000052



9985-1003625



Classic Skull, Painted, 3-part

The muscle origins (red) and insertions (blue) are shown in colour on the left side of the skull. Cranial bones and structures are numbered on the right side. This skull shows over 140 anatomical details.

20x13.5x15.5 cm; 0.7 kg

L/E [www.](#)

9985-1000055

Numbered Classic Skull, 3-part

Numbered skull with skull sutures drawn in colour.

20x13.5x15.5 cm; 0.7 kg

L/D/E/S/F/P/I [www.](#)

9985-1000052

Classic Skull with Opened Lower Jaw, painted, 3-part

Muscle origins (red) and insertions (blue) are represented on the left side of this model.

20x13.5x15.5 cm; 0.7 kg

L/D/E/S/F/P/I [www.](#)

9985-1000054

Skull with Teeth for Extraction, 4-part

The teeth with fully formed roots of upper and lower jaw can be extracted and replaced individually. A bone flap on the right mandible can be opened to view the dental roots, spongiosa, nerve canal and an impacted wisdom tooth.

22x13.5x17 cm; 0.8 kg

9985-1003625

Classic Skull with Opened Lower Jaw, 3-part

This dental skull with opened mandible exposes the dental roots with vessels and nerves. The cranial bones, bone components, fissures, foramina and other structures are numbered. The cranial sutures are shown in colour, as are the meningeal vessels and venous sinuses.

20x13.5x15.5 cm; 0.7 kg

L/D/E/S/F/P/I [www.](#)

9985-1000053



9985-1000053

Functional Skull with Masticator Muscles, 2-part

The masticatory muscles (masseter, temporal, medial and lateral pterygoid muscles) are represented using elastic bands. This model is suitable for demonstrating the function of the masticator muscles with jaw occlusion, the initial stage of jaw opening and the movements of the mandible to the side and front. The skullcap is removable.

20x13.5x15.5 cm; 0.7 kg

9985-1000056



9985-1000056

Classic Skull with Brain, 8-part

This skull can be disassembled into

- Skull Cap
- Base of Skull
- Mandible

The midsagittally divided brain (C18) is cast from an original anatomical specimen.

The components of its left half are:

- Frontal and parietal lobe
- Temporal and occipital lobe
- Encephalic trunk
- Cerebellum

20x13.5x15.5 cm; 1.1 kg

L/E/D/S/F/J

9985-1000049



9985-1000049



9985-1000226





9985-1000059



Deluxe Demonstration Skull, 10-part

This replica of the human skull is of an exceptional quality. The skullcap is removable and the base of skull is mid-sagittally divided. The frontal sinus, perpendicular lamina and vomer are fitted with flaps which can be opened to view the lateral nose wall and sphenoidal sinus. On the left half, the temporal bone can be removed and folded up in the area of the tympanic membrane. Maxilla and mandible are opened to reveal the alveolar nerves. On the right side the temporal bone is opened to reveal the sigmoid sinus, the facial nerve canal and the semicircular ducts. Additional flaps are located at the maxillary sinus and the right half of the mandible, so that the dental roots of the premolars and molars of the lower jaw can also be viewed. The natural occlusion and the individual removal and replacement of each tooth also make this skull especially interesting for dentists. 28x22.5x18.5 cm; 1.5 kg

9985-1000059

Didactic Skull on Cervical Spine, 4-part

This model uses 19 didactic colours to demonstrate the shapes and relationships of the various bone plates of the skull. Flexibly mounted on the cervical spine (C1, C2 and C7 are coloured), this model also shows the hind-brain, spinal cord, spinal nerves of the cervical spine, vertebral arteries, basilar artery and rear cerebral arteries. Mounted on a stand. 18x18x30 cm; 1.4 kg

 E/D/S/F/P/J [www.](http://www.worlddidac.com)

9985-1000048



9985-1000065

Microcephalic Skull

Skull of a young male. This one-part microcephalic skull has an alveolar abscess of the right maxilla with the canine tooth suspended in the abscess. The molars exhibit severe attrition. 27 teeth. Natural cast. 23x16.5x17 cm; 0.8 kg

9985-1000065



9985-1000060

Deluxe Demonstration Skull with Display Case

48x39x36 cm; 4.8 kg

9985-1000060



9985-1000066

Hydrocephalic Skull

The enlarged cerebral cranium is typical of this severe malformation. The skullcap of the one part skull is partially covered by bone skin. The lower right canine and the right molar are decayed. Natural cast. 28x23x19.5 cm; 0.8 kg

9985-1000066



9985-1000067

Skull with Cleft Jaw and Plate

Male. Severe malformation of the left skull half. The one part skull has 29 teeth. Natural cast. 28x23x19.5 cm; 0.8 kg

9985-1000067

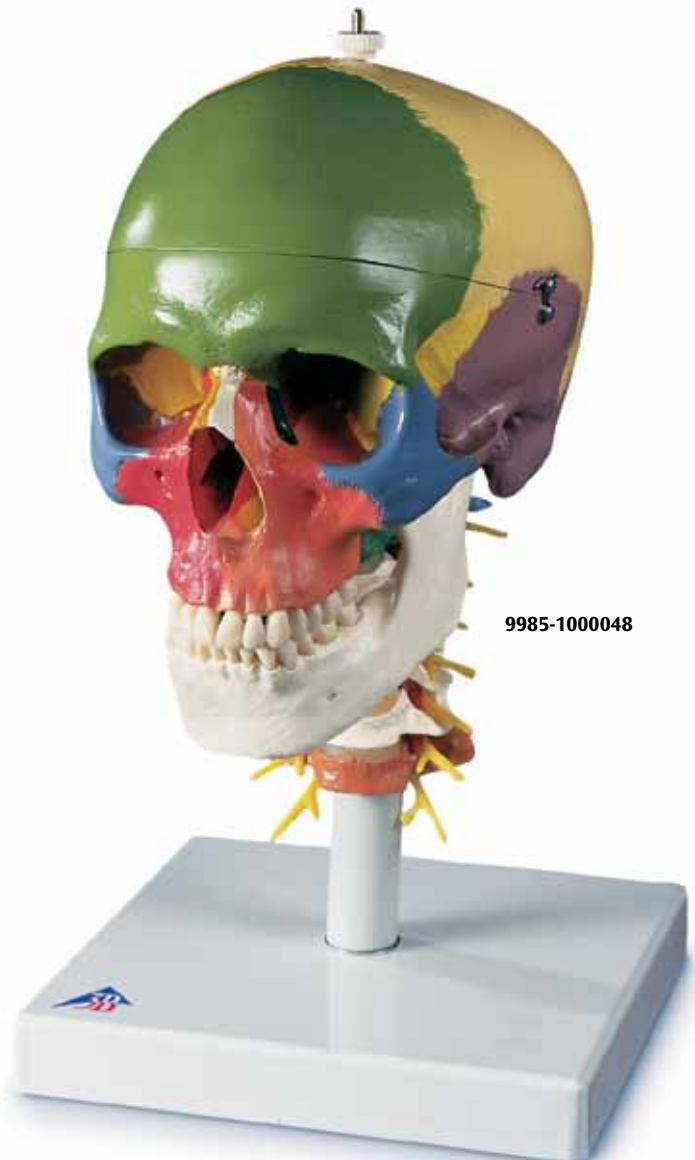

9985-1000048

BESTSELLER

Skulls



9985-1000068



9985-1000069



3B Scientific® Beauchene Skull, 22-part, Didactic Coloured Version

This high quality natural cast made of durable, dimensionally stable plastic reveals the complex structure of the human skull in an exceptionally clear way. The 22 individual bones can be firmly and precisely assembled at the well defined skull sutures using robust inconspicuous connectors. This means that the skull can be handled without falling apart, which differentiates it from alternative wobbly models with magnetic connectors. The perfectly interlocked sutures illustrate the adhesion of a genuine human skull very realistically. The bones are didactically dyed in nine lasting colours for ease of identifying the various skull sections. Pairs of bone plates are the same colour.

The skull consists of the following individual bones:

- Parietal bone (left and right)
- Occipital bone
- Frontal bone
- Temporal bone (left and right)
- Sphenoid bone
- Ethmoid bone
- Vomer bone
- Zygomatic bone (left and right)
- Upper jaw (maxilla) with teeth (left and right)
- Palatine bone (left and right)
- Nasal concha (left and right)
- Lacrimal bone (left and right)
- Nasal bone (left and right)
- Lower jaw (mandible) with teeth

This popular model is produced using accurate casts of the individual bones of a genuine "exploded" skull of European origin and is ideally suited for training osteopaths as well as other professionals.

21x14x16 cm; 0.7 kg

E/D/S/F/P/I/J www.3b.com

9985-1000069

3B Scientific® Skull Kit – Anatomical Version, 22-part as A291, but not coloured

9985-1000068

Neurovascular Skull

A life-size adult skull with seven cervical vertebrae mounted on a stand. The arteries are shown on one side and nerves on the other.

Removing the vault exposes the main nerves and arteries on the floor of the cranium. The 12 cranial nerves and the distribution of their branches is also shown.

29x21x18.5 cm; 1.3 kg

E

9985-1005108

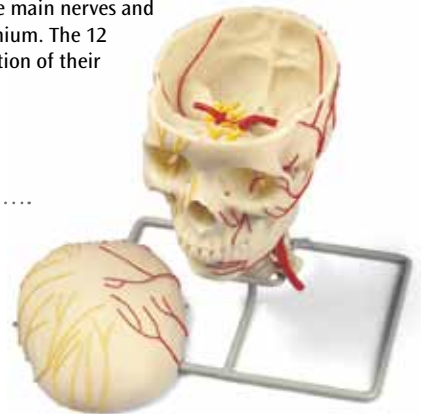

9985-1005108

Foetal Skull, on Stand

Cast of a natural bone foetal head in the 30th week of pregnancy.

18.5x14.5x14 cm; 0.2 kg

9985-1000058

Foetal Skull (not shown)

as A26, but without stand

14x9x9 cm; 0.15 kg

9985-1000057

9985-1000058



Mini Skull, 3-part (not shown)

Our mini skull, which precisely depicts all the anatomical structures, can be disassembled into skullcap, base of skull and mandible.

10x8x8 cm; 0.10 kg

9985-1000041

Anatomy

Unique Worldwide

The starting point for our absolutely realistic 3B Scientific® Systematic Skull was the accurate cast of a perfect original. Specialised production processes and materials guarantee the precise replication of even the minutest anatomical structures. 3B BONElike™ bones look real, feel absolutely natural and weigh the same as natural bones. If you want the world's best skull, our 3B BONElike™ models are just the thing for you! (Please also read the endorsements for 3B BONElike™ bones on page 33.)



9985-1000064

3B BONElike™ System Skull – Didactic Deluxe Skull, 7-part

This unique and high quality model will leave no questions in the study of skull anatomy unanswered! The ability to transfer the structures visible on the transparent half to the bony half give this skull a special didactic value. On the right, transparent skull half the paranasal sinuses can be easily located even from the outside, since these are marked in different colours: maxillary sinus (yellow), ethmoidal cells (orange), frontal sinus (green), sphenoidal sinus (purple). The cranial sinuses and the neck and face arteries are also shown in colour: sinuses of dura mater (blue), common carotid artery, external and internal carotid artery and the branches of the meningeal artery (red). One brain half, which is also visible through the skullcap, allows visualization of the position of the brain and the course of the sinuses. The periodontal pockets and tooth roots can be seen through the transparent jaw. The lower jaw is mounted flexibly to demonstrate the masticator movements. The skull is mounted on a cervical spine and can be disassembled into both halves of the skullcap, the left half of the base of skull, the nasal septum, the complete mandible and a brain half.

35x18x18 cm; 1.0 kg
 E/D/S/F/P/J [www.](http://www.3bscientific.com)

9985-1000064



3B BONElike™ System Skull – Bony Skull Half, 4-part

The left bony half skull has been designed especially for the student's budget. The half skull can be disassembled into skullcap, base of skull, mandible and nasal septum. An affordable first class model to study all anatomical structures.

16x7x21 cm; 0.25 kg
 E/D/S/F/P/J [www.](http://www.3bscientific.com)

9985-1000061

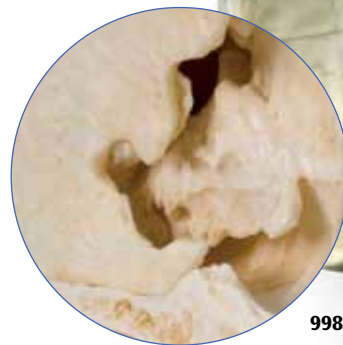

9985-1000061



3B BONElike™ System Skull – Bony Skull, 6-part

This unrivalled, detailed natural cast shows a complete midsagittally sectioned skull. It can be disassembled into both halves of the skullcap and the base of skull, the nasal septum and the complete mandible. To demonstrate masticatory movement, the lower jaw is mounted flexibly. An excellent skull to study the bony structure and complicated anatomy of the human skull. Manufactured from 3B BONElike™, this is the world's best series made skull replica.

16x14x21 cm; 0.5 kg

📖 E/D/S/F/P/J [www.](http://www.3bscientific.com)

9985-1000062



9985-1000062



3B BONElike™ System Skull – Combined Transparent / Bony Skull, 8-part

By combining one transparent and one bony skull half this is the first model to allow teachers of anatomy a topographical juxtaposition of the structures that cannot be seen in other skull versions. The right, transparent skull half allows the study of important anatomical details, such as the location of the paranasal sinuses. Therefore, in combination with the left, bony skull half, a direct transfer of the otherwise invisible structures becomes easy and uncomplicated. The transparency of the jaw allows an exceptional view onto the periodontal pockets and roots. The teeth are removable for detailed studies. In addition, the external masticator muscles (masseter and temporal muscles) are represented on the bony skull half. To demonstrate masticator movement, the lower jaw is mounted flexibly. These features also make the skull especially useful for dentists. The skull can be disassembled into both halves of the skullcap and base of skull, the nasal septum, the complete mandible and both masticator muscles.

16x14x21 cm; 0.54 kg

📖 E/D/S/F/P/J [www.](http://www.3bscientific.com)

9985-1000063



9985-1000063

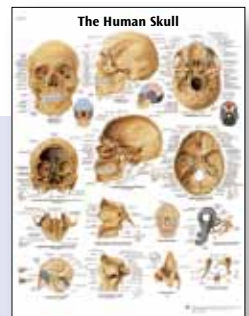

You will find our large selection of Charts starting on page 108.

9985-4006656 *
9985-1001478 **



9985-1000126



9985-1000127



9985-1000131



9985-1008545

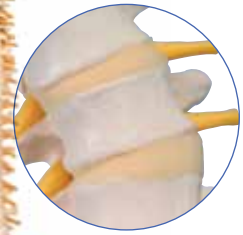

Deluxe Flexible Spine with Femur Heads

All other features as 9985-1000125.
83 cm; 2.1 kg

9985-1000126

Deluxe Flexible Spine with Femur Heads and Painted Muscles

Painted spines add a new dimension to demonstrations. Muscle origins (red) and insertions (blue) are painted on left innominate, femur and vertebrae. For further information see 9985-1000125.

83 cm; 2.1 kg

L/D/E/F/S/P/I/J www.3b.com

9985-1000127

Flexible Spine with Soft Intervertebral Discs

Soft Discs for greater realism.

This unique spine shows how the discs deform during normal and abnormal positioning. Use it to demonstrate any number of pathological conditions such as scoliosis, lordosis, kyphosis or subluxations. Herniation can be demonstrated with compression. In addition, the special mounting allows unobstructed vision viewing during demonstration and display. Includes dura mater of spinal cord and spinal nerves. Supplied on removable stand.

105 cm; 5.0 kg

9985-1008545



9985-1000043

Durable Flexible Spine

Probably the last spine you will ever need! With male pelvis, occipital plate, vertebral artery, spinal nerve exits and a dorsalateral disc prolapse between the 3rd and 4th lumbar vertebrae. Specially mounted on a flexible hose adding extra stability. Ideal for regular active use, such as in schools. Stand is not included, please see 9985-1000132.

74 cm; 1.4 kg

9985-1000130

Durable Flexible Spine with Femur Heads

All other features as 9985-1000130
83 cm; 2.3 kg

9985-1000131

Didactic Flexible Spine with Femur Heads

All other features as 9985-1000128.
82 cm; 2.1 kg

9985-1000129

Mini Vertebral Column, elastic, on stand

Model with squama occipitalis and pelvis. The vertebral column is mounted flexibly to demonstrate natural movements and pathological changes. On a detachable stand.

44 cm; 0.35 kg

9985-1000043

Mini Vertebral Column, elastic

As 9985-1000043, but without stand.

40 cm; 0.25 kg

9985-1000042

Didactic Flexible Spine

This superb new didactically painted spinal column has the same anatomical features as the 9985-1000132. The five different sections of the spinal column are differentiated by colour:

- 7 cervical vertebrae
- 12 thoracic vertebrae
- 5 lumbar vertebrae
- Sacrum
- Coccyx

Use this spinal column for simplified patient education or for lessons in a classroom environment where the didactical colours help to immediately reinforce the explanation, even from a distance.

Stand is not included, please see 9985-1000132 (page 32).

74 cm; 1.9 kg

9985-1000128

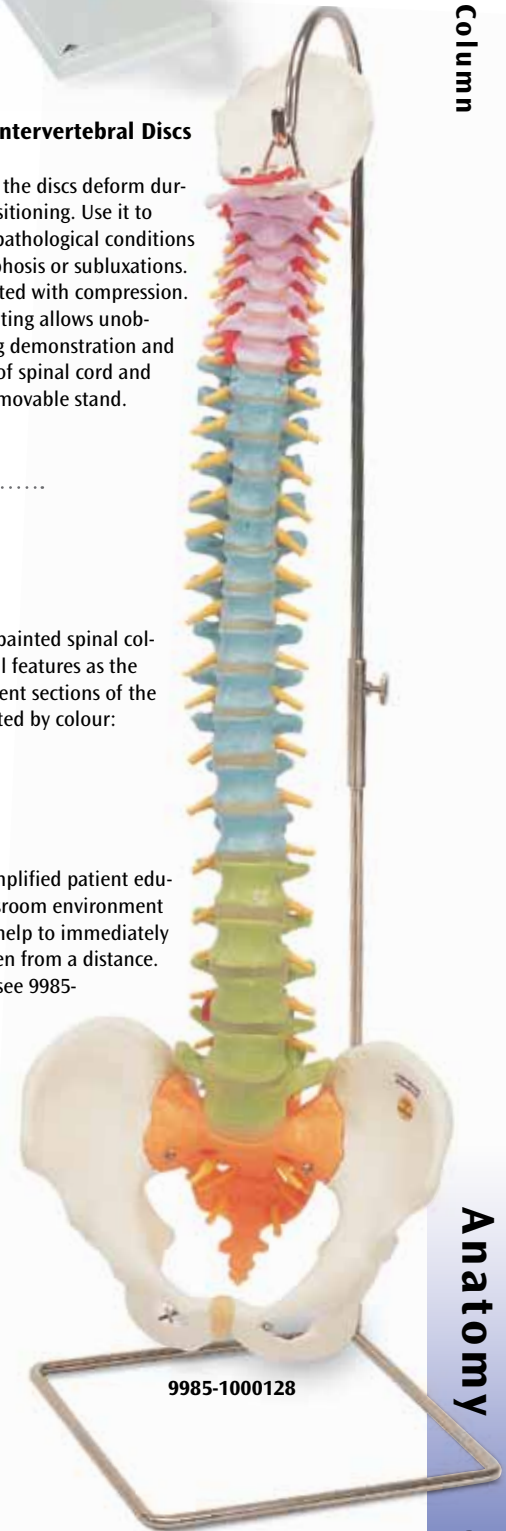

9985-1000128

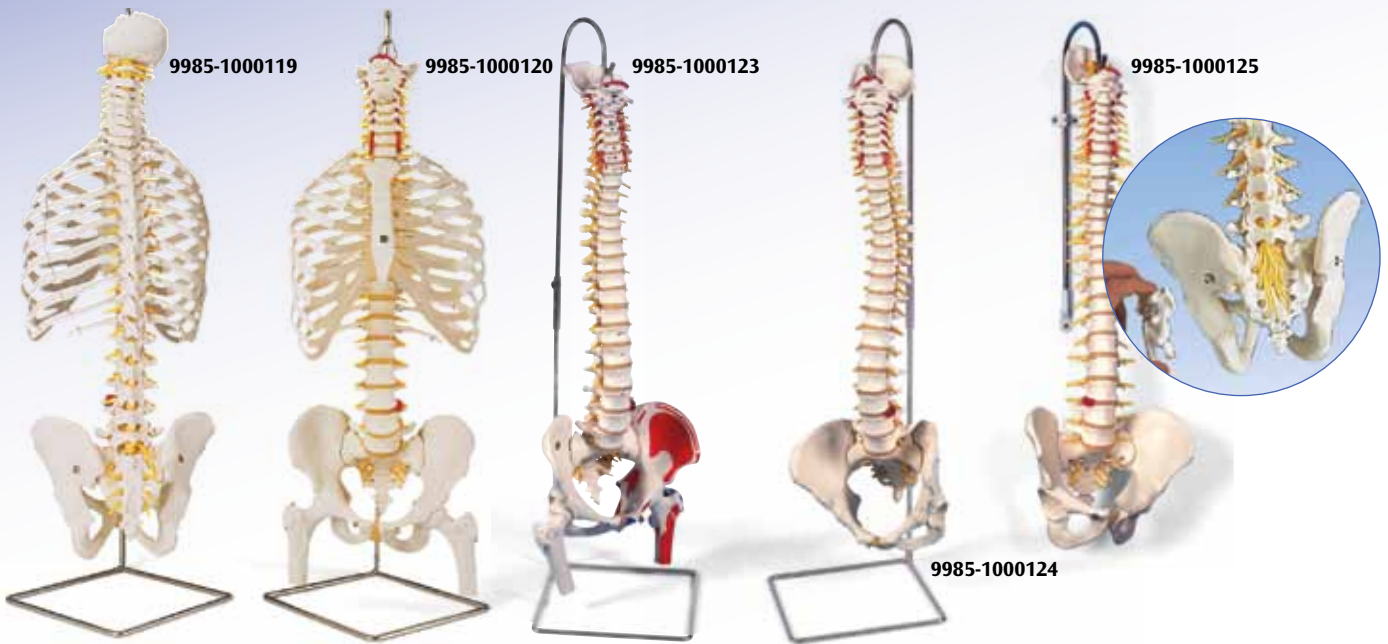

BESTSELLER



9985-1000132

Classic Flexible Spine with Ribs

Flexible spine with ribs shows the interaction of the ribs, spine and associated structures. Contains the following features:

- Extremely good value and durable.
- Full pelvis and occipital plate
- Fully flexible mounting
- L3-L4 disc prolapsed
- Spinal nerve exits
- Cervical vertebral artery
- Male pelvis

Stand is not included, please see 9985-1000132.
74 cm; 2.8 kg

9985-1000119

Classic Flexible Spine with Ribs and Femur Heads

All other features as 9985-1000119.
83 cm; 3.0 kg

9985-1000120

Classic Flexible Spine with Femur Heads and Painted Muscles

Painted spines add a new dimension to demonstrations. Muscle origins (red) and insertions (blue) are painted on left innominate, femur and vertebrae. Same features as 9985-1000132. Stand is not included, please see 9985-1000132.

83 cm; 2.1 kg
L/D/E/F/S/P/I/J [www.](http://www.3BScientific.com)

9985-1000123

Classic Flexible Spine with Female Pelvis

All other features as 9985-1000132.
74 cm; 1.8 kg

9985-1000124

Deluxe Flexible Spine

Additionally to all features of the Classic Spine Series our Deluxe Spine has a sacral opening and exposed brainstem for advanced studies. Other features are:

- Full pelvis and occipital plate
- Fully flexible mounting
- L3-L4 disc prolapsed
- Spinal nerve exits
- Cervical vertebral artery
- Male pelvis
- Cauda equine

Stand is not included, please see 9985-1000132.
74 cm; 1.8 kg

9985-1000125

Multifunctional Spinal Column Stand, 3-part

Unique worldwide:
• Can be placed on the floor
• Mounted on a wall!
• Made of nickel-plated steel

9985-1000132

3B BONElike™ Vertebral column

See 9985-1000157 on page 33.



9985-1000122

Classic Flexible Spine

Our most popular spine for patient education is also our most affordable. Fully flexible and designed for hands-on demonstrations. Contains these features:

- Full pelvis and occipital plate
- Fully flexible mounting
- L3-L4 disc prolapsed
- Spinal nerve exits
- Cervical vertebral artery
- Male pelvis

Stand is not included, please see 9985-1000132.
74 cm; 1.8 kg

9985-1000121

Classic Flexible Spine with Femur Heads

Same features as 9985-1000132, additionally with femur heads.
83 cm; 2.1 kg

9985-1000122

Pelvic Skeleton, female

See A61 on page 37.

9985-1000121

3B BONElike™ Vertebrae

Cast from natural bone human vertebrae giving precise replication of even the finest anatomical details.

- Feels and looks like real bones.
- Realistic weight.
- Excellent real bone substitutes for medical teaching and patient consultation.
- Each vertebra is marked for identification (C1-7, T1-12 and L1-5).

3B BONElike™ Vertebral Column

Flexible, mounted, true to life model of the human vertebral column in excellent BONElike™ quality with exact reproduction of all anatomical details, based on real weight. Consists of the male pelvis and occipital bone. Occipital bone and atlas can be detached individually. Without stand, see 9985-1000132, page 32. 85 cm; 1.5 kg

9985-1000157

Set of 24 BONElike™ Vertebrae

This set includes the 7 cervical, 12 thoracic and 5 lumbar vertebrae. Each vertebra is labeled for identification purposes (C1-7, T1-12 and L1-5). Supplied in a transport and storage case with individual compartments for all 24 vertebrae. 41x40x12 cm; 2.4 kg

9985-1000156

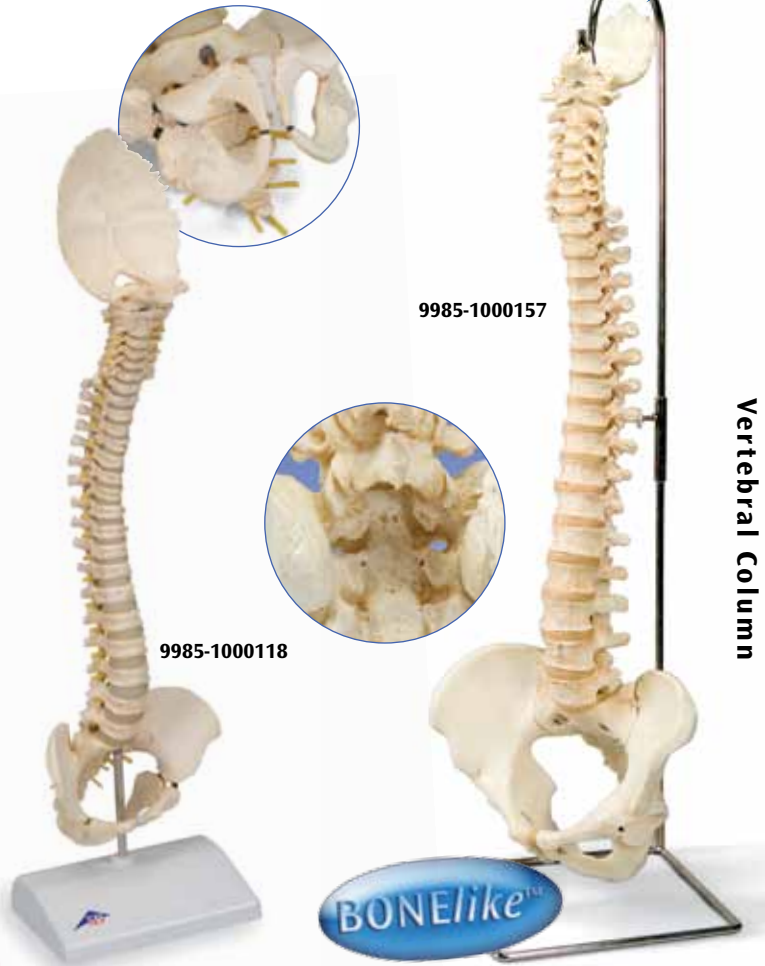

Vertebral Column



9985-1000156

3B BONElike™ Human Child Vertebral Column

This true to life model of the vertebral column of a child of about 5 years old is particularly interesting for those working in anatomy, paediatrics, orthopaedics and paediatric radiology. The unique material of the model makes it almost indistinguishable visually from a real vertebral column. This flexible, movable vertebral column including occipital bone, pelvis and sacrococcyx is mounted on a stand. Within the spinal canal, the spinal cord with cauda equina and exiting nerve roots are represented with flexible material. This model is particularly useful for studying the phase of bone growth characteristic for the developmental stage of a 5 year old. This includes:

- Vertebrae – still partially incomplete development of vertebral bodies and vertebral arches.
- Sacrum – as yet incomplete fusion of individual sacral vertebrae. This commences at around the age of 15.
- Pelvis – still open Y cartilage as main growth plate of the acetabulum. The hip, pubic and ischial bone parts are not yet connected (didactically fixed with brackets in the model). These fuse around the age of 14-16.

14x9x51cm; 0,5 kg

9985-1000118



“It is a unique reproduction of a bone that cannot be distinguished from a real one. One of my staff members, a world renowned bone specialist, was not able to distinguish the vertebra from a real one. I wish your company much success with your excellent artificial preparations.” (Prof. Dr. Dr. h.c. Horst Erich König, Director of the Institute for Anatomy at the University of Veterinary Medicine, Vienna)

“In the first moment, I actually believed it was real bone! My compliments, the material has excellent tactile feel.” (Dr. med. Yvonne Kammerer, Institute of Anatomy of the University of Regensburg, Germany)

I am convinced that you have developed the best bone ever created by man.” (Professor Vladimir Ovcharov, MD, DSc Rector of Medical University – Sofia)





Cervical Spinal Column

Consisting of, occipital plate, the 7 cervical vertebrae with intervertebral discs, cervical nerves, vertebral arteries and spinal cord. On flexible stand. 19 cm; 0.3 kg

9985-1000144

Thoracic Spinal Column

Consisting of the 12 thoracic vertebrae with intervertebral discs, thoracic nerves and spinal cord. On flexible stand. 32 cm; 0.5 kg

9985-1000145

Lumbar Spinal Column

Consisting of the 5 lumbar vertebrae with intervertebral discs, sacrum with flap, coccyx, spinal nerves and dura mater of spinal cord. On flexible stand. 34 cm; 0.6 kg

9985-1000146



Atlas and Axis, with Occipital Plate

Assembled, on removable stand.

9985-1000142



Atlas and Axis

Assembled, on removable stand.

9985-1000141



Sacrum and Coccyx

Assembled.

9985-1000139

3 Lumbar Vertebrae, Flexibly Mounted

Anatomically correct in every single detail. Flexibly mounted with spinal nerves and dura mater of spinal cord.

11 cm; 0.15 kg

9985-1000151



6 Mounted Vertebrae

Consisting of atlas, axis, another cervical vertebra, two thoracic vertebrae with intervertebral discs and one lumbar vertebra. On removable stand. 22 cm; 0.3 kg

9985-1000147

5 Vertebrae (not shown)
Atlas, axis, cervical, thoracic and lumbar vertebrae. Loosely threaded on nylon.

9985-1000148

Atlas and Axis (not shown)
Assembled, no stand.

9985-1000140

Lifting Demonstration Figure

Clearly demonstrates the effects of correct and incorrect lifting techniques on the spinal column.

28x21x21.5 cm; 1.4 kg

E

9985-1005101



Set of 7 3B BONElike™ Cervical Vertebrae

Supplied on a base. 30x21x6 cm; 0.3 kg

9985-1000021

Set of 5 3B BONElike™ Lumbar Vertebrae

Supplied on a base. 30x21x6 cm; 0.3 kg

9985-1000155



9985-1000158

Stages of Disc Prolapse and Vertebral Degeneration

This model gives a very clear illustration of lumbar vertebrae with intervertebral discs, comparing healthy and a degenerative condition. Both disc prolapse and protrusion, with associated changes to the vertebra are depicted. The model can be disassembled into its components (vertebral bodies, intervertebral discs and spinal nerves).

22 cm; 0.5 kg
 L/E/D/F/S/P/I/J

9985-1000158

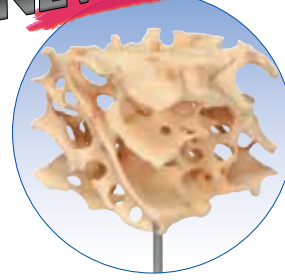

9985-1000152

2 Lumbar Vertebrae with Prolapsed Disc, Flexibly Mounted

With spinal nerves and dura mater of spinal cord.
 7.4 cm; 0.15 kg

9985-1000152

9985-1000150

Lumbar Spinal Column with Dorso-lateral Prolapsed Intervertebral Disc

Between the 3rd and 4th lumbar vertebrae. On stand, removable.
 34 cm; 0.55 kg

9985-1000150



Spinal disorders



9985-1000149

Lumbar Spinal Column with Prolapsed Intervertebral Disc

2 lumbar vertebrae with spinal nerves, dura mater of spinal cord and 2 replaceable dorso-lateral prolapsed discs between the 4th and 5th lumbar vertebrae. On stand, removable.
 13 cm; 0.27 kg

9985-1000149



9985-1000153

Deluxe Osteoporosis Model (3 Vertebrae)

Consisting of 3 medially divided lumbar vertebrae with intervertebral discs. For comparison, the upper section shows healthy bone structure, the middle section osteoporotic bone structure and the lower section advanced osteoporotic bone structure with flattened plates, deformation and decreased mass. For detailed study the vertebrae can be removed from the stand.
 16 cm; 0.25 kg

9985-1000153



You will find our large selection of Charts starting on page 108.

9985-4006657 *
 9985-1001480 **

...going one step further

UNIQUE!

Spinal disorders



9985-1000182



Osteoporosis Model

Impressive didactic model for comparing osteoporotic and normal thoracic vertebrae. Ideal for medical studies and patient education. The 11th and 12th thoracic vertebrae are shown. Reproductions of sequential osteoporotic thoracic vertebrae with narrower intervertebral disc are located on the left of the stand. The upper vertebra is divided in the middle. The magnetically attached vertebral half can be removed easily to show the cut surfaces. This allows clear visualisation of the fractured upper part of the vertebral body caused by sintering, i.e. collapse of the bony substance in the course and as a result of osteoporosis. Degenerative changes in the bone, manifested as osteophytes, are also identifiable. For comparison, reproductions of two corresponding healthy vertebrae with intervertebral disc are provided on the right side. One half of the upper vertebral body is also magnetically attached and can be removed. Each set of vertebrae also has a sticker on the stand showing two 3D micro CT images obtained from bone biopsies. These illustrate the microarchitecture of the osteoporotic bone, which has a lower bone density compared to healthy bone.

14x9x10 cm; 0.2 kg
 L/D/E/F/I/S/P/J/R/C www.

9985-1000182

Herniated Disc Simulator

This innovative model shows the injured mechanism of a herniated disc. The simulator demonstrates how the intervertebral disc prolapses when flexing the vertebrae, reproducing what happens in real life when we bend or twist our trunk. Since vertebral disorders are widespread, therapists should have this model to make people aware of the importance of gentle movements and behaviours for the spinal column. This model will be of great assistance in medicine, physiotherapy, medical surgeries and clinics, moving and handling, ergonomics, physical education and other fields. The model consists of two vertebrae with an elastic intervertebral disc, spinal cord and nerves.

Size: 12x11.5x9 cm; weight 0.6 kg

9985-1005326

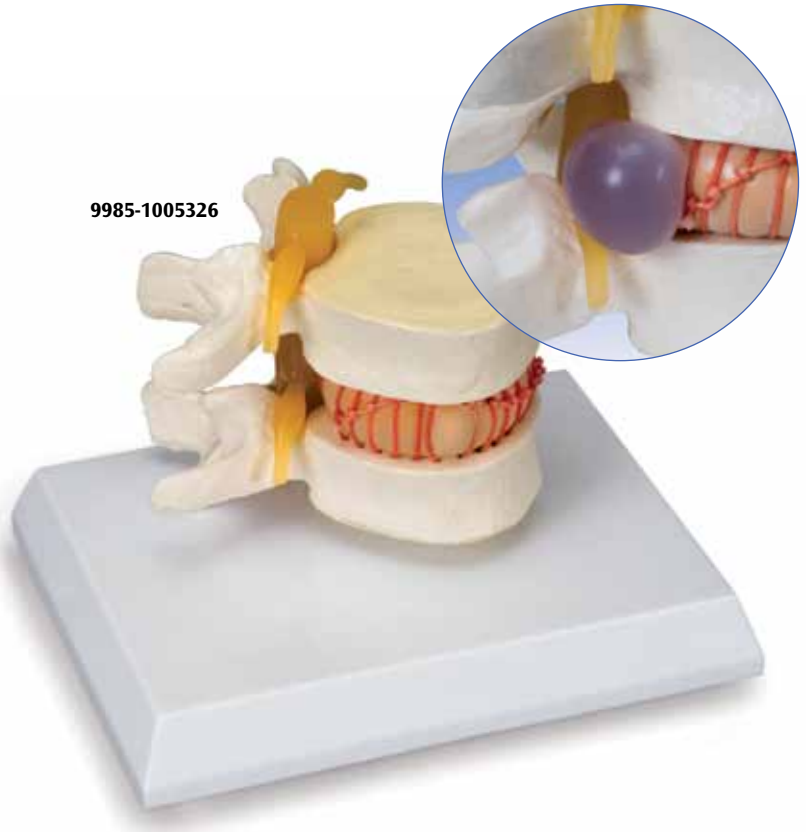

9985-1005326



9985-1005866

4-Stage Degenerative Lumbar Set

An exceptional model demonstrating bone and disc degeneration. The vertebrae pairs (L4, L5) demonstrate from left to right: a normal disc and bone; Facet Syndrome and a herniated disc; thinning disc and the beginning of bone spurring; a seriously degenerated disc with bone fusing.

Mounted on base.
 8.5 cm, 0.5 kg

E

9985-1005866

You will find our large selection of Charts starting on page 108.



9985-4006653 *
 9985-1001472 **

Anatomy



9985-1000133



9985-1000135



9985-1005110

Pelvis with Ligaments, Nerves and Floor Muscles

A life size bony female pelvis showing the ligaments and the main nerves, with a removable 2-part pelvic floor.
27x20x18 cm; 1.0 kg

Pelvis



9985-1000134

Pelvic Skeleton, Male

Consisting of hip bone, sacrum with coccyx and 2 lumbar vertebrae.
18x28x23 cm; 0.8 kg

9985-1000133

Pelvic Skeleton, Female, with Movable Femur Heads

Consisting of hip bone, sacrum with coccyx and 2 lumbar vertebrae as well as movable symphysis.
30x30x20 cm; 1.2 kg

9985-1000135

Pelvic Skeleton, Female

Consisting of hip bone, sacrum with coccyx and 2 lumbar vertebrae as well as movable symphysis.
19x25x24 cm; 0.9 kg

9985-1000134

9985-1005110

Ligamented Female Pelvis

This life-size, one-piece teaching aid is fitted with synthetic pelvic ligaments which in life hold the bones of the pelvic girdle together.
27x20x18 cm; 0.9 kg

9985-1005106



9985-1005106



9985-1000285

Female Pelvis, 3-part

Three part model representing an original cast of a bony female pelvis, shows all the details of anatomical structures: Two hip bones, the pubic symphysis, the sacrum and the coccyx, the fifth lumbar vertebra with intervertebral disc. A midsagittal section through the fifth lumbar vertebra, sacrum and coccyx, allow both halves of the pelvis to be disassembled revealing a part of the cauda equina in the vertebral canal. The left half of the fifth lumbar vertebral body is removable.

19x27x19 cm, 0,9 kg

L/D/E/F/I/S/P/J/R/C www.3b-bone.com

9985-1000285



9985-1005112

Female Pelvis and Pelvic Floor, 5-part

A pelvis of synthetic bone-like material with a highly detailed and dissectible pelvic floor in carefully coloured flexible material, comprising genitalia and associated muscles.

27x20x18 cm; 1.0 kg

E

9985-1005112

Female Pelvis Skeleton with Genital Organs, 3-part

It consists of female pelvis with a movable symphysis, hip bone, sacrum, coccyx, 2 lumbar vertebrae and a female genital insert with rectum. Womb and bladder can be removed. Delivered on base.

33x26x18 cm; 2 kg

9985-1000335



9985-1000335





9985-1000286

Female Pelvis with Ligaments, 3-part

This three part model represents an original cast of a bony female pelvis, which shows all details of anatomical structures. Two hip bones, the pubic symphysis, the sacrum and the coccyx, the fifth lumbar vertebra with intervertebral disc. A midsagittal section through the fifth lumbar vertebra, sacrum and coccyx, allow both halves of the pelvis to be disassembled revealing a part of the cauda equina in the vertebral canal. The left half of the fifth lumbar vertebra is removable. The right half of the model shows following pelvic ligaments: inguinal ligament, sacrotuberous ligament, sacrospinous ligament, anterior sacroiliac ligaments, iliolumbar ligament, anterior longitudinal ligament, interosseous sacroiliac ligament, posterior sacroiliac ligament and obturator membrane.

19x27x19 cm, 1,0 kg

L/D/E/F/I/S/P/J/R/C [www.](http://www.3BScientific.com)

9985-1000286

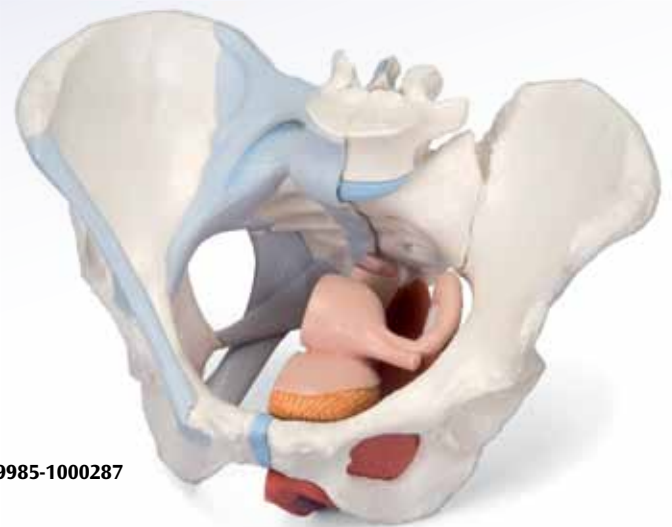

9985-1000287

Female Pelvis with Ligaments, Midsagittally Sectioned through Pelvic Floor Muscles and Organs, 4-part

This four part model of a female pelvis represents detailed information about the topography of bones, ligaments, pelvic floor muscles and female pelvic organs. The right half shows the bones with pelvic ligaments.

In addition, the left half of the pelvis contains the muscles of the pelvic floor including levator ani, ischiocavernosus, deep and superficial transverse perineal, external anal sphincter, external urethral sphincter. A partially removable bulbospongiosus demonstrates the vestibular bulb and Bartholin gland. The removable midsagittal section through the urinary bladder, vagina, uterus and rectum demonstrates the relationship of the muscles of the pelvic floor to the openings for urethra, vagina and rectum.

19x27x19 cm, 1,3 kg

L/D/E/F/I/S/P/J/R/C [www.](http://www.3BScientific.com)

9985-1000287

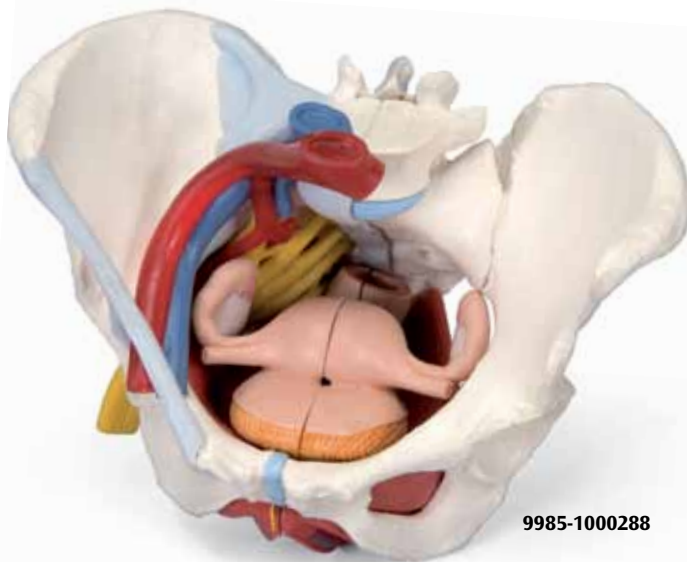

9985-1000288

Female Pelvis with Ligaments, Vessels, Nerves, Pelvic Floor and Organs, 6-part

This six part model of a female pelvis represents detailed information about the topography of bones, ligaments, vessels, nerves, pelvic floor muscles and female pelvic organs. It presents the whole pelvic floor with partially removable midsagittally sectioned external anal sphincter, external urethral sphincter, deep and superficial transverse perineal and bulbospongiosus.

Rectum, uterus with fallopian tubes ovaries and vagina are also removable and can be disassembled into 2 halves by midsagittal section. The right pelvic half demonstrates the divisions and topographical anatomy of the common iliac artery, the external and internal artery and also of the common iliac vein and the external iliac vein. The right sacral plexus, right sciatic nerve and right pudendal nerve are also shown. Bones and ligaments presented: Two hip bones, the pubic symphysis, the sacrum and the coccyx, the fifth lumbar vertebra with intervertebral disc. A midsagittal section through the fifth lumbar vertebra, sacrum and coccyx, allow both halves of the pelvis to be disassembled revealing a part of the cauda equina in the vertebral canal. The left half of the fifth lumbar vertebral body is removable. The right half of the model shows following pelvic ligaments: inguinal ligament, sacrotuberous ligament, sacrospinous ligament, anterior sacroiliac ligaments, iliolumbar ligament, anterior longitudinal ligament, interosseous sacroiliac ligament, posterior sacroiliac ligament and obturator.

19x27x19 cm, 1,6 kg

L/D/E/F/I/S/P/J/R/C [www.](http://www.3BScientific.com)

9985-1000288

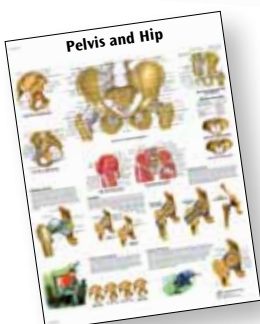

You will find our large selection of Charts starting on page 108.

9985-4006660 *
9985-1001486 **

The High-Quality 3B Scientific® Joint Collection

This unique series is designed to allow clear understanding of the functional movement and anatomy of large joints. A “preparative” demonstration of topographical anatomy from the surface to the joint leaves a lasting impression through dismantling and re-joining of the muscles which are involved in joint movement. This means a lot of anatomy for relatively low cost!

9985-1000176

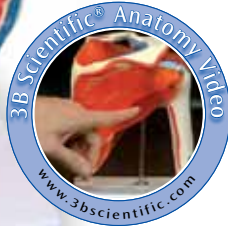

Shoulder Joint with Rotator Cuff, 5-part

This model comprises the upper half of the humerus, the clavicle and the shoulder blade. The muscles of the rotator cuff are displayed and the sites of origin and insertion of the shoulder muscles are highlighted in colour (origin = red; insertion = blue). By removing the individual muscles, all movements of the shoulder joint can be performed. Mounted on a stand. 18x18x24 cm; 0.85 kg

L/E/D/S/F/P/I/J [www.](http://www.3bscientific.com)

9985-1000176

Hip Joint, 7 part

The model shows the right hip joint of a male with the individual muscles as well as the muscle origins and insertions on the femur and the hip bone. For educational purposes, the origin and insertion areas of the muscles have been raised and presented in colour (muscle origin = red; muscle insertion = blue). The hip muscles have been mounted on their corresponding regions of origin and insertion and are thus removable. 18x32x18 cm; 1.5 kg

L/E/D/S/F/P/I/J/R/C [www.](http://www.3bscientific.com)

9985-1000177



9985-1000177

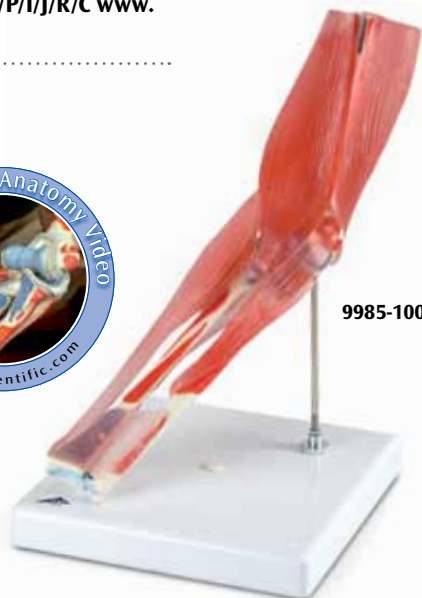

9985-1000179

Elbow Joint, 8-part

This model shows the right elbow of a male with individual muscles and the muscular origins and insertions on humerus, radius and ulna. For didactic reasons, the areas of the muscular origins and insertions are raised and colour coded (origin = red, insertion = blue). The muscles can be attached to and removed from the corresponding areas of origin and insertion. 25x41x25 cm; 1.2 kg

E/D/S/F/P/I/J [www.](http://www.3bscientific.com)

9985-1000179

Knee Joint, 12-part

Completing our set of joints and their muscles, we are proud to introduce this 12-part knee model. It shows different removable muscles and muscle portions of the knee area. Colour coded and raised areas indicate the muscle origin and insertion points on the femur, tibia, and fibula. In addition parts of the fibular and tibial collateral ligaments are represented. All the muscles of the leg are easily removable to permit study of the deeper anatomical layers. 33x17x17 cm; 0,9 kg

L/D/E/F/I/S/P/J/R/C [www.](http://www.3bscientific.com)

9985-1000178

9985-1000178





9985-1000175

Femoral Fracture and Hip Osteoarthritis

This model was developed to provide patients with understandable information, e.g. before surgery. It shows the right hip joint of an elderly person in half natural size. In addition, a frontal section through the femoral neck is shown in relief on the base. The model shows the femoral fractures that occur most commonly as well as typical wear and tear symptoms of the hip joint. The following fractures are shown: medial femoral neck fracture, lateral femoral neck fracture, fracture through the trochanteric region, fracture below the trochanters, femoral shaft fracture, femoral head fracture, fracture of the greater trochanter, fracture or avulsion of the lesser trochanter. Mounted on base. 14x10x22 cm; 0.3 kg

E/D/S/F/P/J [www.](http://www.3bscientific.com)

9985-1000175



9985-1000003

Sports Shoulder

Includes upper half of humerus, clavicle and scapula. Articulated to show normal movement. Depicts the following:

- M. supraspinatus
- Long head tendon
- Glenoid labrum
- Rotator cuff

Stand included. 23x17x12 cm; 0.4 kg

E

9985-1000003



9985-1002390

Deluxe Knee

Distal half of femur attached to tibia, fibula and patella. Depicts all major muscles of the knee. Cruciate/collateral ligaments simulated with triple springs. Simulated "Bucket Handle" tear in medial meniscus. Patellar tendon simulated. Stand included.

33x12x12 cm; 0.7 kg

E

9985-1002390



9985-1000180

Sectional Knee Joint Model, 3-part

This model can be used to demonstrate various disorders of the human knee joint and their respective therapies in a graphic way. The model shows a natural sized, healthy right knee joint in upright position, including parts of the femur, tibia and fibula as well as the ligament system and the patella with part of the femoral tendon. The patella and attached tendon and the front half of the model (which is frontally sectioned) can be detached. Mounted on base.

12x12x24 cm; 0.5 kg

L/E/D/S/F/P/I/J [www.](http://www.3bscientific.com)

9985-1000180



9985-1005100

Sectional Knee Joint

Longitudinal section of the human knee joint. Bone structure, meniscus, joint cartilage, synovial membrane and joint ligaments are shown in colour.

18.5x8.5x5 cm; 0.3 kg

E

9985-1005100

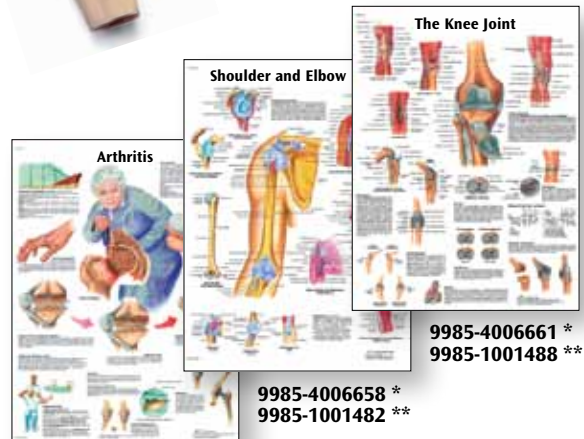

9985-4006654 *
9985-1001474 **

9985-4006661 *
9985-1001488 **

9985-4006658 *
9985-1001482 **

You will find our large selection of Charts starting on page 108.

3B Scientific® Joint Series

These functional models provide an accurate demonstration of the anatomy and mechanics of the major joints, allowing better doctor-patient or teacher-student understanding. Use these life size and fully flexible joints to demonstrate abduction, anteversion, retroversion, internal/external rotation and much more. Mounted on a stand.

BESTSELLER



Joints

Functional Shoulder Joint

Consists of shoulder blade, collar bone, portion of humerus and joint ligaments.
16x12x20 cm; 0.35 kg

9985-1000159

Functional Hip Joint

Consists of portion of femur, hip bone and joint ligaments.
17x12x33 cm; 0.55 kg

9985-1000161

Functional Knee Joint

Consists of portion of femur, tibia and portion of fibula; also includes meniscus, patella with quadriceps tendon and joint ligaments.
12x12x34 cm; 0.4 kg

9985-1000163

Functional Elbow Joint

Consists of portion of humerus, complete ulna and radius as well as joint ligaments.
12x12x39 cm; 0.5 kg

9985-1000165

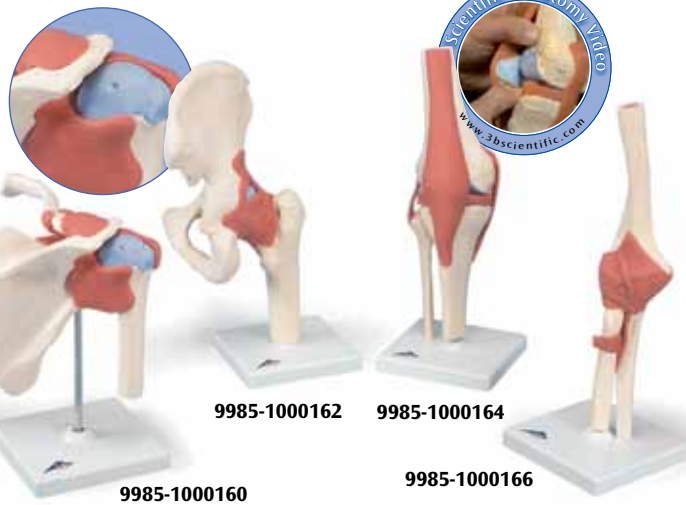

Deluxe Functional Shoulder Joint Model

Consists of shoulder blade, collar bone and upper arm stump.
Mounted on a base. 22 cm; 0.41 kg

9985-1000160

Deluxe Functional Hip Joint Model

Consists of thigh stump and hip bone. Mounted on a base.
32 cm; 0.56 kg

9985-1000162

3B Scientific® Deluxe Functional Joint Models

These high quality functional models of a lifesized right joint with ligaments shows the anatomy and natural physiological movements (e.g. abductions, anteversion, retroversion, internal and external rotation) in exceptional detail. The colour of the natural cast bones is extremely realistic. The cartilage on the joint surfaces is marked in blue. Mounted on a base.

L/E/D/S/F/P/I/J

Deluxe Functional Knee Joint Model

Consists of thigh stump, shinbone stump and calf bone stump, menisci and patella. Mounted on a base.
32 cm; 0.55 kg

9985-1000164

Deluxe Functional Elbow Joint Model

Consists of a stump of the upper arm, ulna and radius. Mounted on a base. 33 cm; 0.285 kg

9985-1000166

3B Scientific® Mini Joint Series

Following in the footsteps of their successful larger brothers, these mini-joints have been reduced to a half their natural size but have kept all of their functionality. In addition to the external anatomical structures, using the superb new joint cross-sections mounted on base, the medical or teaching professional now has the ability to explain what is happening "within".

Also available without base:

Mini Hip Joint

16,5x8,5x9 cm; 0.1 kg

9985-1000167

Mini Shoulder Joint

12x10x5 cm; 0.05 kg

9985-1000171

Mini Knee Joint

20x6,5x5 cm; 0.13 kg

9985-1000169

Mini Elbow Joint

17,5x4x3.5 cm; 0.05 kg

9985-1000173



Mini Hip Joint with Cross Section

With base. 16x12x20 cm; 0.2 kg

9985-1000168

Mini Elbow Joint with Cross Section

With base. 16x12x20 cm; 0.2 kg

9985-1000174

Mini Knee Joint with Cross Section

With base. 10x14x24 cm; 0.35 kg

9985-1000170

Mini Shoulder Joint with Cross Section

With base. 12x14x16 cm; 0.2 kg

9985-1000172

...going one step further

Anatomy

BESTSELLER

Dual Sex Muscle Figure, 45-part

The finest teaching tool available! Standing over 138 cm tall, this 3/4 life size human replica depicts deep and superficial musculature in addition to the body's major nerves, vessels, tissues and organs in exquisite detail. The internal organs are removable (45 pieces in all) to reveal the fundamental inter-relationships of human morphology. Remove the calvarium to view the 3-part removable brain. Look beneath the liver to reveal the gall bladder and bile duct. Peer inside the appendix, stomach lungs, heart or kidney. Remove and view the details of 13 different muscles of the arms and legs. This dual sex version has interchangeable genital inserts and a female mammary gland as well as a detailed multilingual key card identifying the hand numbered structures. Over 600 hand numbered and identified structures. Hand painted in realistic colours and mounted on a convenient roller base. Includes the following features:

- 5 arm/shoulder muscles
- 8 leg/hip muscles
- 2-part removable heart
- 5-part head including removable brain
- 2-part removable lungs
- 2-part stomach
- Removable 4-part male and 2-part female genital inserts
- Detachable arms, leg, head, and abdominal wall for detailed study

138x50x32 cm; 12.4 kg

 L/D/E/F/S/P/I/J [www.](http://www.3BScientific.com)

9985-1000206

Female Muscle Figure, 23-part

This female muscle figure without internal organs, brain and male genital inserts provides the same quality characteristics as the model 9985-1000206. This model consists of 23 parts, including 13 arm/leg muscles. Remove the calvarium to view the 3-part removable brain. Hand painted in realistic colours and mounted on a convenient roller base, there is simply no finer reproduction available! Includes the following features:

- 5 arm/shoulder muscles
- 8 leg/hip muscles
- Detachable arms, leg, head and abdominal wall for detailed study

138x45x32 cm; 11.2 kg

 L/D/E/F/S/P/I/J [www.](http://www.3BScientific.com)

9985-1000207



Muscular Figures

Anatomy

9985-1000206

Something Very Special

Versions 9985-1001235 as well as 9985-1001236, 9985-1001237 (p. 55), 9985-1001238 and 9985-1008541 (p. 50) were developed in the teaching aid workshops of the German Museum of Hygiene in Dresden, a world renowned institute of medical training and information.

Life-size Male Muscular Figure, 37-part

This sophisticated model shows the deep and superficial musculature in great detail. The extraordinary accuracy makes this masterpiece a unique tool for teaching even in large lecture halls. Following parts can be removed and studied in detail: skull cap, 6-part brain, eyeball, breast and abdominal wall, both arms, 2-part larynx, 2 lungs, 2-part heart, diaphragm, 2-part stomach, liver with gall bladder, kidney, whole intestine system, bladder half, 2-part penis, 10 muscles.

180x110x50 cm; 26.0 kg

L/D/E/F/S

9985-1001235

Life-Size Muscle Torso, 27-part

This is the muscle torso for particularly demanding studies, showing the deep and superficial muscles in great detail. With extraordinary accuracy and manufactured in life size, this masterpiece is a unique aid for anatomic demonstrations even in large lecture halls. The following parts can be removed for detailed studies: skull cap, 6-part brain, eyeball with optic nerve, chest / abdominal wall, 2-part larynx, 2 lungs, 2-part heart, diaphragm, 2-part stomach, liver with gall bladder, complete intestinal tract with appendix, front half of kidney, half urinary bladder, 4 muscles.

95x60x35 cm; 14.0 kg

L/D/E/F/S

9985-1001236



Muscular Figures

9985-1001235 disassembled



9985-1001236 disassembled



9985-1001236



9985-1001235



9985-1000210 /
9985-1000211

Complete Dual Sex Muscular Figure, with internal organs, 33-part

The whole human anatomy in a convenient size. This 84 cm high version of our deluxe muscle figure is a perfect choice for thorough demonstrations of human musculature and internal organs where space is an issue.

Exquisitely hand detailed and complete with 33 removable and/or dissectible parts, this version represents fine quality at a more affordable price. Painted by hand in realistic colours, this model comes complete with stand and detailed multilingual product manual.

It includes the following features:

- 5 arm/shoulder muscles
- 8 leg/hip muscles
- 2-part removable heart
- 2-part removable brain
- 2 Removable lungs
- Removable 2-part male and 2-part female genital inserts
- Detachable arm and abdominal wall for detailed study
- Almost 400 hand numbered and identified structures

84x30x30 cm; 5.0 kg

L/D/E/F/S/P/I/J [www.](http://www.3BScientific.com)

9985-1000210

Complete Female Muscular Figure, 21-part

The whole human anatomy in a convenient size without internal organs or male genital inserts for where space is an issue. This model comes complete with stand and detailed multilingual product manual. It includes the following features:

- 5 arm/shoulder muscles
- 8 leg/hip muscles
- Detachable arm and abdominal wall for detailed study
- Over 400 hand numbered and identified structures

84x30x30 cm; 5.0 kg

L/D/E/F/S/P/I/J [www.](http://www.3BScientific.com)

9985-1000211

Muscular Figure, 1/3 life-size, 2-part

Mini muscle model's (57 cm) appeal is its value for money. All the superficial musculature of the human form is accurately reproduced and detailed in life like colours in this desktop size version. The chest plate is removable to reveal the internal organs and the right side contains a female mammary gland. Over 125 hand numbered and identified structures. Delivered on base.

57x25x18 cm; 2.1 kg

L/D/E/F/S/P/I/J [www.](http://www.3BScientific.com)

9985-1000212



9985-1000212

3B Scientific® Life-Size Dual Sex European Muscular Figure, 39-part

This life-size, high quality model represents a wide variety of human anatomical structures in accurate detail. It is therefore especially suitable for the high demands of medical school. The right half shows the skin, the left half the superficial and more profound muscles with nerves, vessels and bony structures. The versatility of this model, which is also aesthetically designed, is rounded off by the accurate representation of the internal organs. Its components are:

- 2-part head
- Brain half
- Sternocleidomastoideus muscle
- 6-part muscle arm (detachable: deltoid muscle, biceps muscle of arm, triceps muscle of arm, long palmar muscle with radial flexor muscle of wrist, brachioradial muscle with radial extensor muscle of wrist)
- 5-part upper leg (detachable: sartorius muscle, gluteus maximus muscle, rectus femoris muscle, long head of biceps femoris muscle with semi-tendinous muscle)
- 2-part lower leg (detachable: gastrocnemius muscle)
- Chest/abdominal wall with detachable mammary gland
- Torso body with skin arm and leg
- 2 lung halves
- 2-part heart
- Liver with gall bladder
- 2-part stomach
- Half kidney
- 4-part intestine set
- 3-part female genital insert with embryo
- 4-part male genital insert

Includes the 3B ANATOMY *trainer*™ and 3B MUSCLE *trainer*™ study programs on CD-ROM (page 95) and a CD-ROM with illustrations and descriptions of the individual structures. Supplied with wooden roller base and assembly instructions.

174 cm; 28 kg

L/D/E/F/S/P/J

9985-1000209

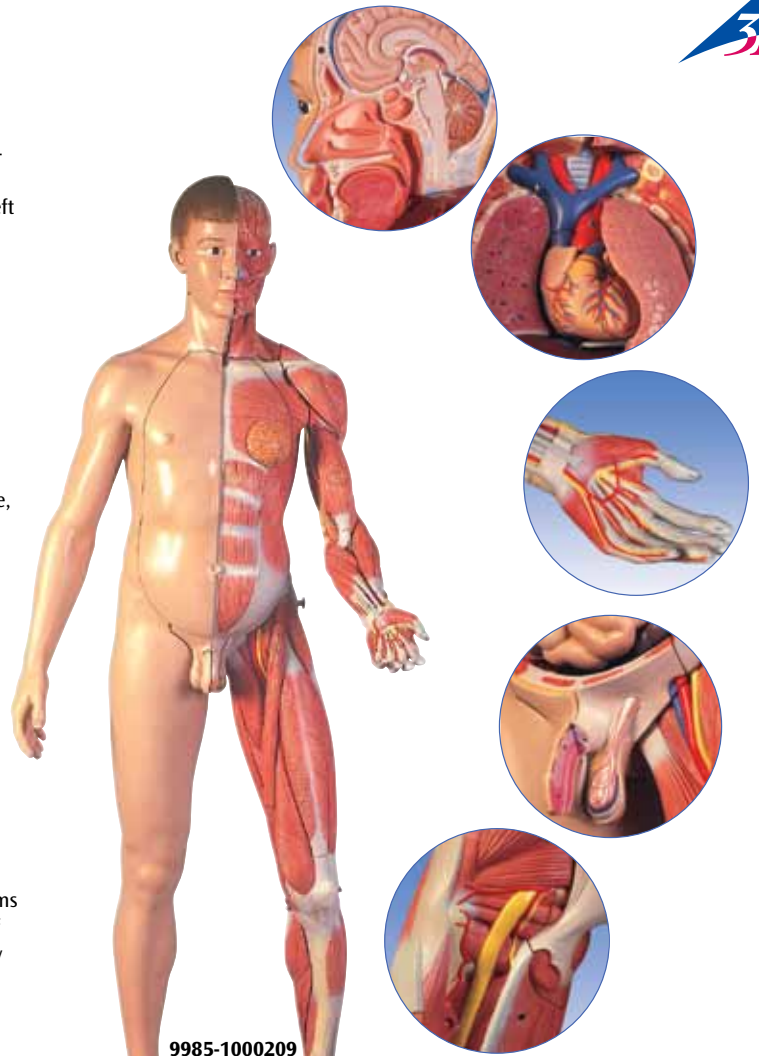

9985-1000209



3B Scientific® Life-Size Dual Sex Asian Muscular Figure, 39-part

Provides all quality characteristics and components of the 3B Scientific® Muscular Figure 9985-1000209, but with asian facial features.

174 cm; 28 kg

L/D/E/F/S/P/J

9985-1000208

9985-1000208



You will find our large selection of Charts starting on page 108.



9985-400652 *
9985-1001470 **

9985-4006514 *
9985-1001149 **

9985-4006516 -
9985-1001153 +

...going one step further



9985-1002387

Motor Neuron Diorama

Magnified more than 2,500 times, this model represents a fully three-dimensional reproduction of a motor nerve cell situated within a milieu of interacting neurons and a skeletal muscle fibre. The membranous envelope has been cut away from the neuron to expose the cytological ultrastructure, organelles and inclusions within the cell body. Branching dendrites, communicating synapses and a myelin wrapped axon with node of Ranvier, project from the neuronal surface. A section of the axon lifts off to let you view the tightly wound layers of the enveloping myelin sheath and neurolemma, as well as the Schwann cell which formed them. Mounted on a wooden base.

43x20x28 cm; 3.0 kg
 E

9985-1005553

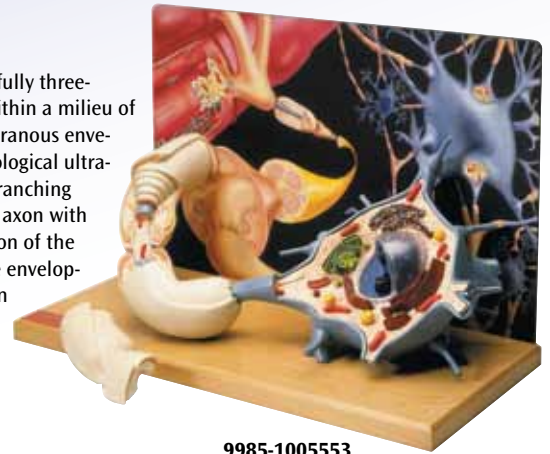

9985-1005553

Deluxe Arm

Cast from natural bone specimen. Bones of hand show radius, ulna, humerus, scapula and clavicle. Depicts all major muscles, nerves and arteries of the shoulder, elbow and hand. Stand included.

84x33x28 cm; 2.7 kg
 E

9985-1002387

Dissectable Muscled Arm, 6-part

This model illustrates both the superficial and deeper muscles, five of which are removable. Tendons, vessels, nerves and bone components of the left arm and shoulder are shown in great detail. Parts are accurately numbered. Delivered on removable stand.

60x18x18 cm; 1.9 kg
 L/D/E/F/S/P/I/J www.

9985-1000015



9985-1000015

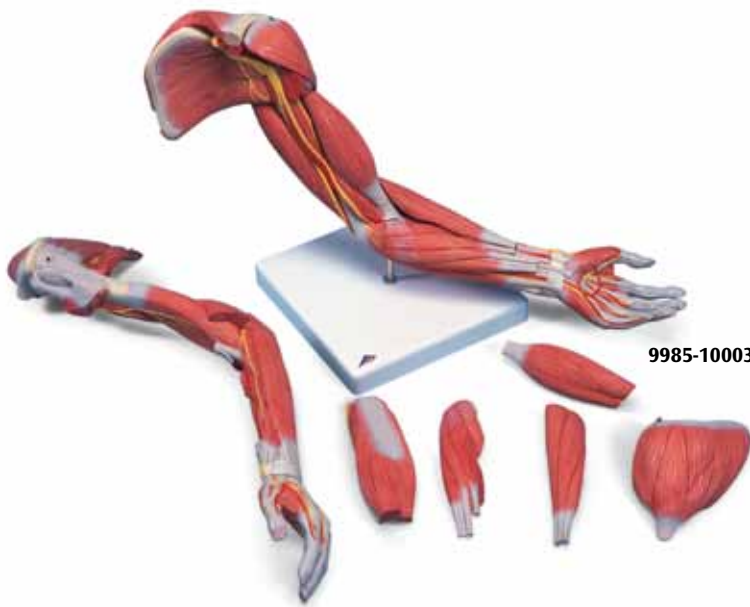

9985-1000347

Muscular Arm, 6-part

The following muscles can be detached in this life-size model:

- Deltoid muscle
- Biceps muscle of arm
- Triceps muscle of arm
- Long palmar muscle with radial flexor muscle of wrist
- Brachioradial muscle with radial extensor muscle of wrist

Supplied on base.
 70 cm; 3.0 kg
 L/D/E/F/S/P/I/J www.

9985-1000347

9985-1000358



see page 23

9985-1000179



see page 39

9985-1000003



see page 40

9985-1000176



see page 39



9985-1002389

Deluxe Leg

Cast from natural bone specimen. Bones of foot, tibia and fibula, femur, coccyx, sacrum and innominate articulated.

- Depicts all major muscles and nerves of the hip, knee and foot
- Hip articulation shown with a capsule
- Femur can be removed
- "Bucket Handle" tear depicted on knee
- Physiological movement

Stand included.
102x41x30.5 cm; 7.7 kg

E

9985-1002389

Muscular Leg, 7-part

This life size model can be disassembled into upper and lower leg. The following muscles can be detached:

- Sartorius muscle
- Gluteus maximus muscle
- Rectus femoris muscle
- Long head of biceps femoris muscle with semitendinous muscle
- Gastrocnemius muscle

Supplied on base.

100 cm; 7.0 kg

L/D/E/F/S/P/J [www.](http://www.3b.com)

9985-1000352



9985-1000353

Muscular Leg, 9-part

The model illustrates both the superficial and deeper muscles, eight of which are removable. Tendons, vessels, nerves and bone components of the left leg and foot are shown in great detail. Parts numbered. Delivered on removable stand.

77x26x26 cm; 4.0 kg

L/D/E/F/S/P/I/J [www.](http://www.3b.com)

9985-1000351

Lower Muscled Leg with Knee, 3-part

This life size model can be divided horizontally at the knee joint for viewing the joint structures. The gastrocnemius muscle can be detached. Supplied on a base.

58 cm; 2.6 kg

L/D/E/F/S/P/J [www.](http://www.3b.com)

9985-1000353



9985-1000351

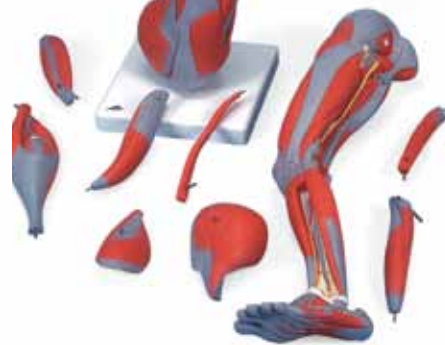

9985-1000352

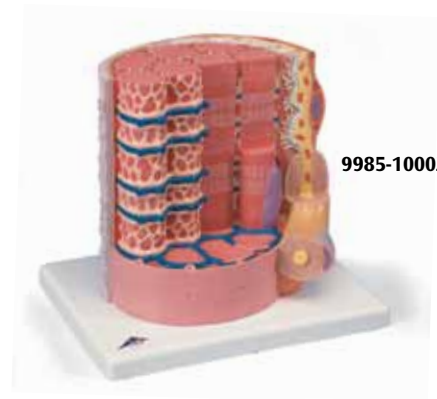

9985-1000213

3B MICROanatomy™ Muscle Fibre

The model illustrates a section of a skeletal muscle fibre and its neuromuscular end plate magnified approx. 10.000 times. The muscle fibre is the basic element of the diagonally striped skeletal muscle.

23.5x26x18.5 cm; 1.1 kg

L/E/D/S/F/P/I/J

9985-1000213

9985-1000360

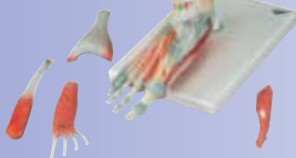

see page 24

9985-1002390



see page 40

9985-1000177



see page 39

9985-1000178



see page 39

3B Scientific® Torsos

Torsos with musculature, life-size or smaller, for secondary education or for medical training: if top-quality human torso-models are important to you, then 3B Scientific is exactly the right choice for you! Our torsos are developed in close coordination with anatomy professors and doctors, and are made in Germany by highly specialised model builders with high quality, toxicologically harmless materials. Since this practice is unfortunately not the case with all manufacturers, consider your health and that of your students and patients and ensure that you are ordering anatomical models with harmless components by asking for an independent study guaranteeing the same.

We were the first manufacturer to order a long term study of one of our models (Torso 9985-1000190) to be examined to verify the safety of our materials. This study was carried out by the TÜV (the nationally recognized independent German inspection organisation). A report of the results can be found on our webpage www.3bscientific.com/downloads,d.html. Because hands-on training tools should not only be vivid and thrilling but also safe!

Whether you choose from the Classic Series, the Luxury Series or one of our special versions, every 3B Torso is:

- developed and modelled in Germany
- accurately manufactured from high quality, harmless materials
- painted by hand true to natural detail

And Classic and Luxury Torsos come with our detailed 3B Scientific® Torso Guide including a CD-ROM.

Torsos

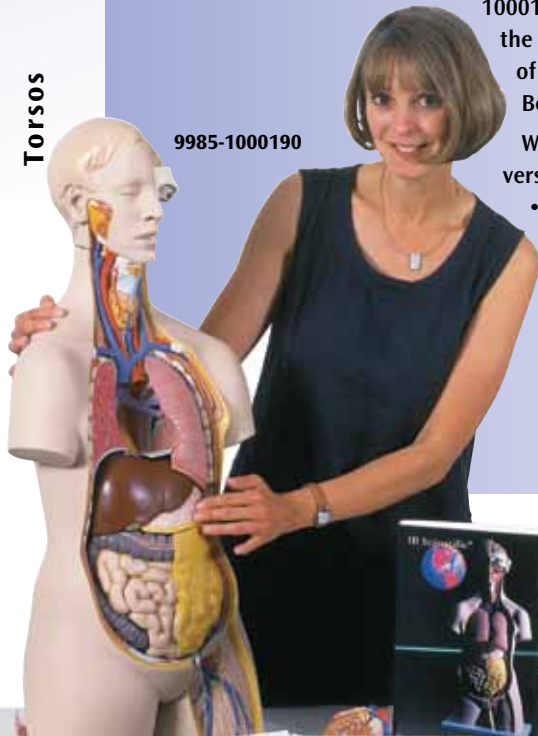

9985-1000190



9985-1000183

BESTSELLER

9985-1000184

Description
see page 49



Classic Unisex Torso, 14-part

This popular school torso is supplied with the following removable parts:

- 3-part head
- 2 lungs
- 2-part heart
- Stomach
- Liver with gall bladder
- 2-part intestinal tract
- Front half of kidney
- Front half of urinary bladder

Supplied with 3B Torso Guide.
87x38x25 cm; 5.9 kg

9985-1000190

3B Torso Guide

- Brilliant coloured pictures of each part of the torsos
- Even the smallest structures are explained
- Valuable teaching tips to create more interesting lessons
- Complete with 7 different languages (Latin, English, German, Spanish, Portuguese, French, Japanese)
- Also on a CD-ROM in pdf format to assist in creating tests or preparing lessons
- Supplied complete in a coloured filing system.

9985-1000183

Classic Unisex Torso, 12-part

The following components of this torso are removable:

- 2-part head
 - 2-part removable heart
 - 2 lungs
 - Stomach
 - Liver with gall bladder
 - 2-part intestinal tract
 - Front half of kidney
- Supplied with 3B Torso Guide.
87x38x25 cm; 4.6 kg

9985-1000186

Classic Unisex Torso, 10-part

(not shown)
Same as B09, but without head.
Supplied with 3B Torso Guide.
70x38x25 cm; 4.1 kg

9985-1000187

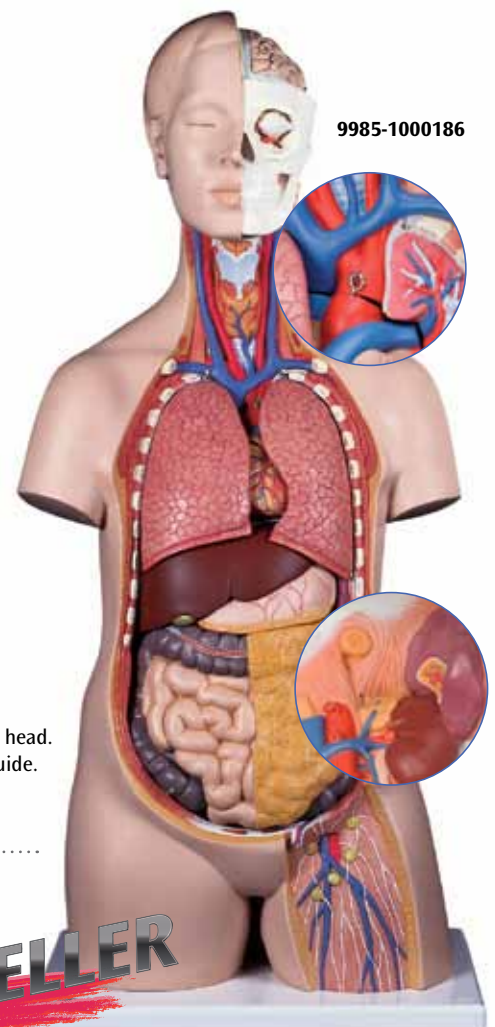

9985-1000186

BESTSELLER

Classic Unisex Torso, 11-part

(not shown)
Same as 9985-1000190, but without head.
Supplied with 3B Torso Guide.
70x38x25 cm; 5.5 kg

9985-1000189

**Classic Unisex Torso,
16-part**

This torso is especially popular among students. It shows the human anatomy in great detail and contains the following removable parts:

- 3-part head
- 2 lungs with sternum and rib attachments
- 2-part heart
- Stomach
- Liver with gall bladder
- 4-part intestinal tract
- Front half of kidney
- Front half of urinary bladder

Supplied with 3B Torso Guide (page 48).
87x38x25 cm; 6.8 kg

9985-1000188

3B Torso Classroom Set

Includes 33 brilliant overhead foils with coloured pictures of each part of the torsos.

9985-1000184

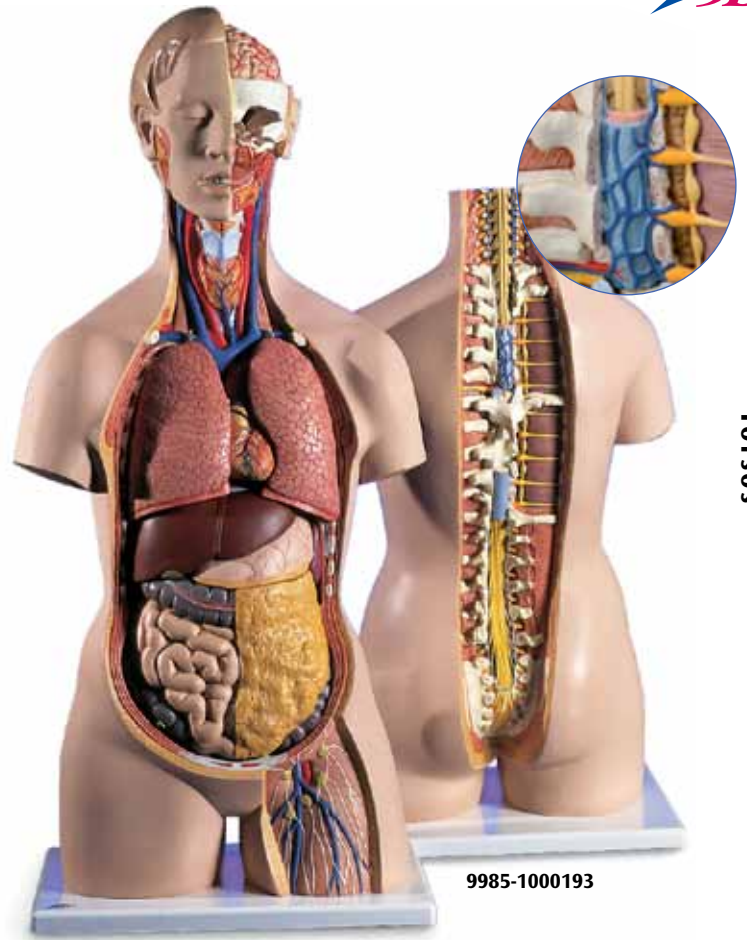

TORSOS

9985-1000193

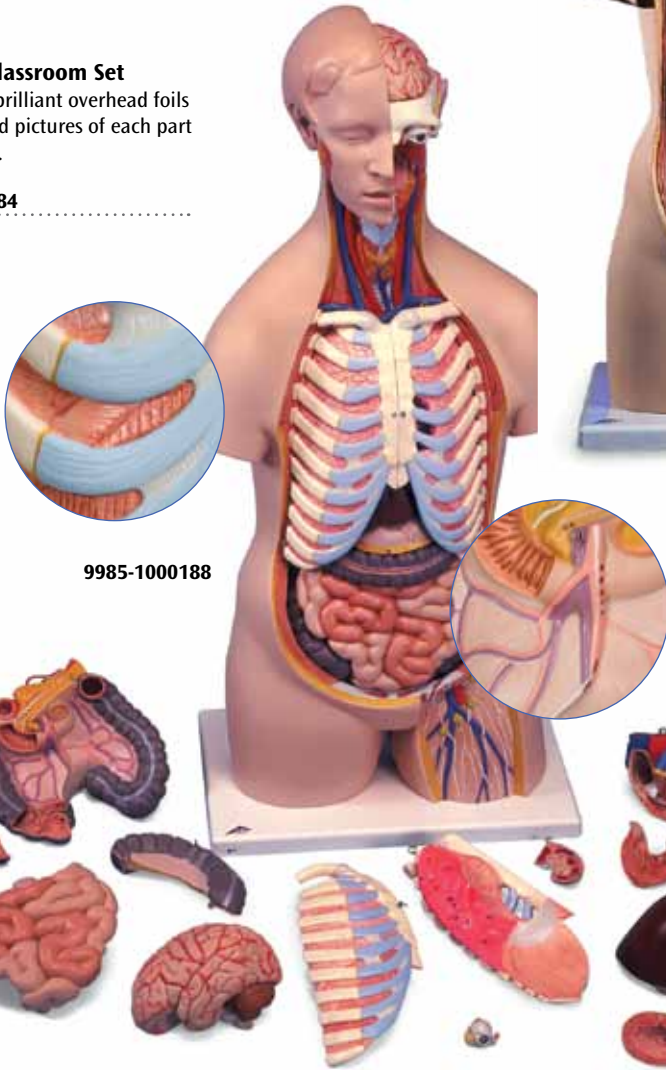

9985-1000188

**Classic Unisex Torso with
Opened Neck and Back,
18-part**

Based on our 9985-1000190 torso, this model is characterised by its open neck and back section reaching from the cerebellum to the coccyx. Vertebrae, intervertebral discs, spinal cord, spinal nerves, vertebral arteries, and many other features are represented in detail and can be studied closely. It contains the following new features additionally to 9985-1000190:

- 7th thoracic vertebra removable
- 6-part head

Supplied with 3B Torso Guide (page 48).
87x38x25 cm; 5.8 kg

9985-1000193

Overview: Classic-Torsos

Product Number	9985-1000187	9985-1000189	9985-1000186	9985-1000190	9985-1000188	9985-1000193	9985-1000192	9985-1000201	9985-1001238	9985-1008541
Parts	10	11	12	14	16	18	21	14	17	11
Open Back	–	–	–	–	–	yes	yes	–	yes	–
Head	–	–	2-part	3-part	3-part	6-part	6-part	3-part	2-part	1-part
Lungs	yes	yes	yes	yes	yes	yes	yes	yes	yes	yes
Rib Representation	–	–	–	–	yes	–	yes	–	–	–
Heart	2-part	2-part	2-part	2-part	2-part	2-part	2-part	2-part	2-part	2-part
Stomach	1-part	1-part	1-part	1-part	1-part	1-part	2-part	1-part	2-part	2-part
Liver/Gall Bladder	yes	yes	yes	yes	yes	yes	yes	yes	yes	yes
Intestinal Tract	2-part	2-part	2-part	2-part	4-part	2-part	4-part	1-part	1-part	1-part
Half Kidney	yes	yes	yes	yes	yes	yes	yes	yes	yes	yes
Half Urinary Bladder	–	yes	–	yes	yes	yes	yes	yes	yes	yes



9985-1001238

Unisex Torso with Fixed Head, Back and Shoulder Opened, 17-part

Its neck and back section is opened from the 1st cervical to the 3rd lumbar vertebra and its left shoulder is opened to reveal part of the shoulder blade and part of the humerus. The following parts are made of hard plastic and removable:

- Eyeball with optic nerve
- Brain half
- 2 lungs
- 2-part heart
- 2-part stomach
- Liver with gall bladder
- Intestinal tract
- Front half of kidney
- 1 cervical vertebra, 1 thoracic vertebra, lumbar vertebra
- Pancreas with duodenum
- Front half of bladder

92x42x25 cm; 13.6 kg

L/D/E/F/S

9985-1001238

Unisex Torso with Fixed Head, 11-part

(not shown)

- Eyeball with optic nerve
- 2 lungs
- 2-part heart
- 2-part stomach
- Liver with gall bladder
- Intestinal tract
- Front half of kidney
- Closed back and shoulders

92x42x25 cm; 7.5 kg

L/D/E/F/S

9985-1008541

Classic Unisex Torso with Open Back, 21-part

This torso is based on the 9985-1000188 version for students and is equipped with an open neck and back section going from the cerebellum to the coccyx. Vertebrae, intervertebral discs, spinal cord, spinal nerves, vertebral arteries, and many other features are represented in detail. This version contains the following new features in addition to 9985-1000188:

- 7th thoracic vertebra removable
- 6-part head
- 2-part stomach

Supplied with 3B Torso Guide (page 48).

87x38x25 cm; 6.5 kg

9985-1000192

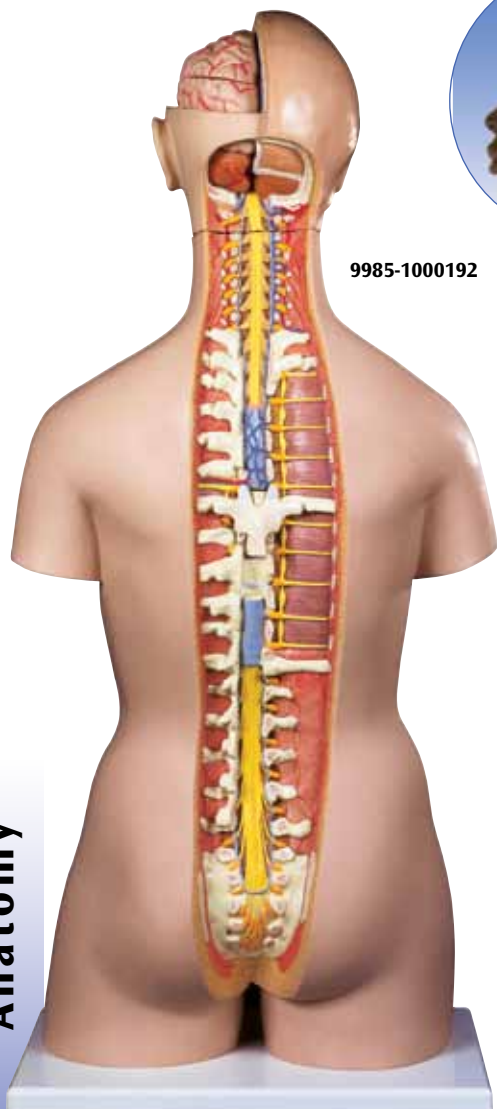

9985-1000192

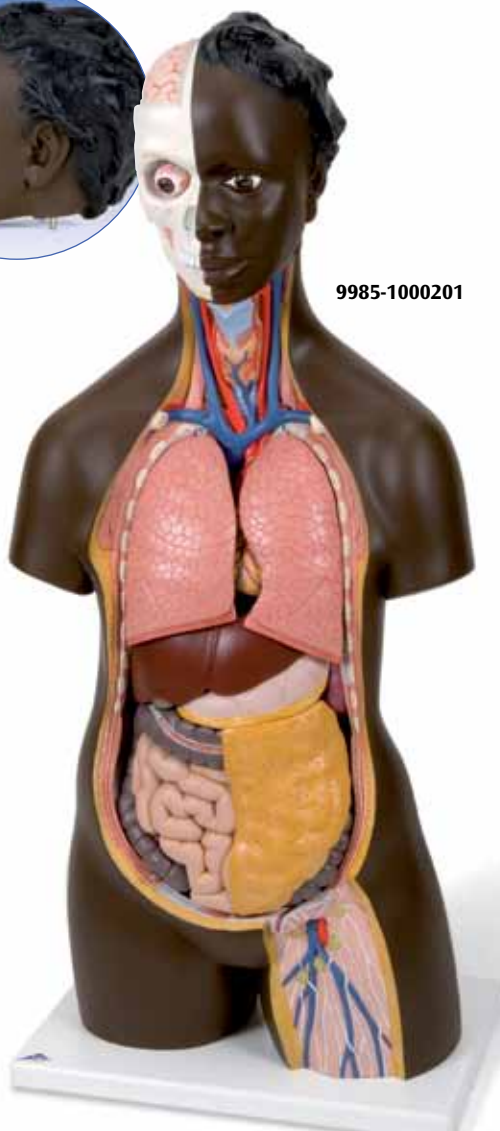

9985-1000201

African Unisex Torso, 14-part

This popular school torso is supplied with the following removable parts:

- 3-part head
- 2 lungs
- 2-part heart
- Stomach
- Liver with gall bladder
- 2-part intestinal tract
- Front half of kidney
- Front half of urinary bladder

Supplied with 3B Torso Guide (page 48).

87x38x25 cm; 5.9 kg

L/D/E/F/S/P/I/J/C/R www.3bscientific.com

9985-1000201

Deluxe Torso Series

The 3B Scientific® Deluxe Torso Series offers all the options you need for detailed demonstrations. You get 100% quality and a high standard of detailed manufacturing. In addition, all torsos of this series are equipped with male and/or female genital inserts, with a 3-month foetus in its correct intrauterine position.

If a unisex torso is not enough for you and a dual-sex torso too much, why don't you choose one of our female or male torsos? Both 9985-1000185 and 9985-1000191 contain the following removable components:

- 3-part head
- 2-part heart
- 2-part stomach
- Liver with gall bladder
- 4-part intestinal tract
- Front half of kidney

Deluxe Dual Sex Torso, 20-part

The quality of this torso is impressive, just like the price! Use it to answer all the questions on internal human anatomy you ever had. It contains these removable components:

- 2-part head
 - Female chest wall
 - 2 lungs
 - 2-part heart
 - Stomach
 - Liver with gall bladder
 - 2-part intestinal tract
 - Front half of kidney
 - 4-part male genital insert
 - 3-part female genital insert with embryo
- Supplied with 3B Torso Guide (page 48).
87x38x25 cm; 7.3 kg

9985-1000197

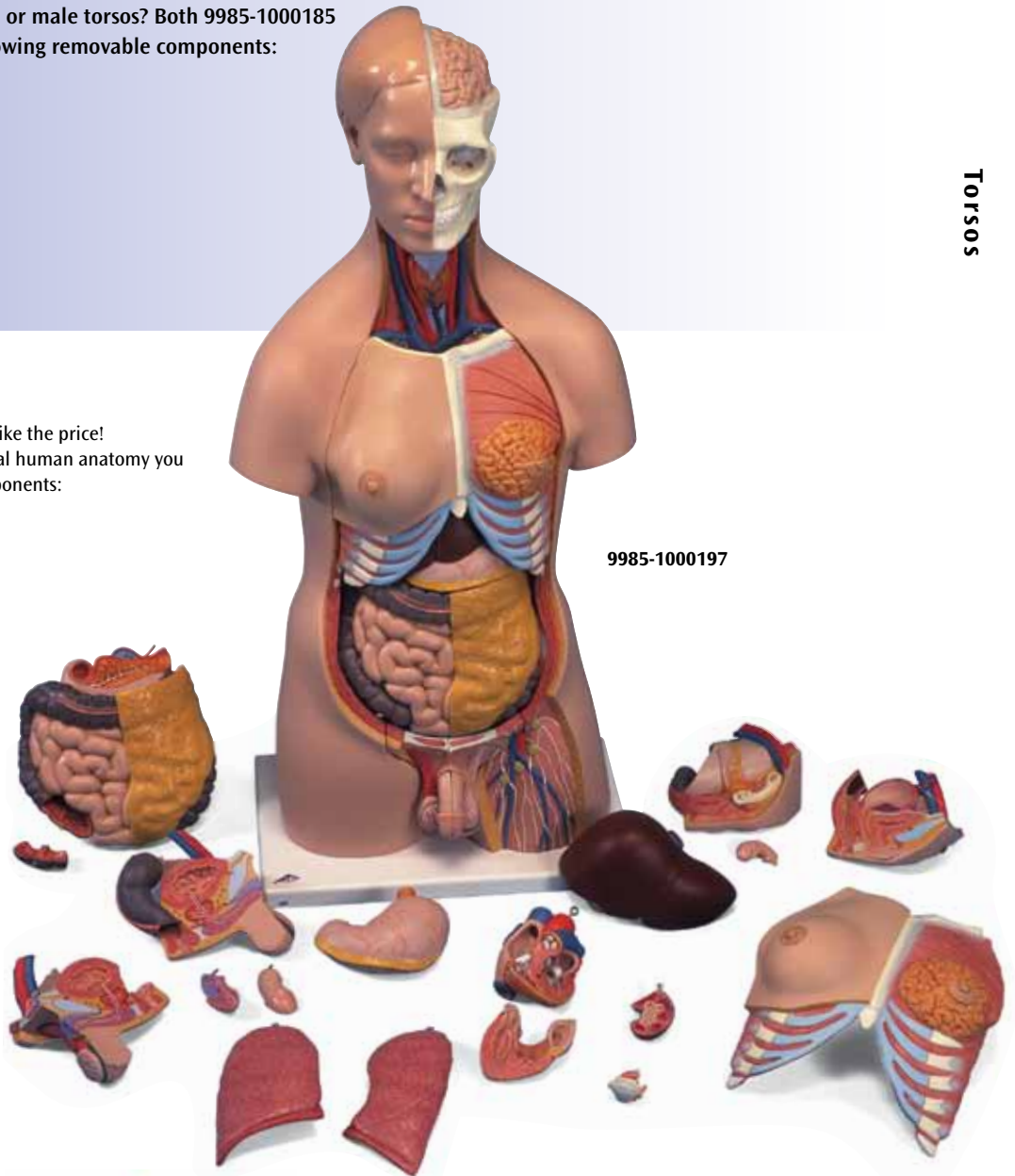

9985-1000191 closed



9985-1000191

9985-1000185



Male Deluxe Torso, with Head, 20-part

Additionally featuring:

- 2 lungs with sternum and rib attachments
 - 4-part male genital insert
- Supplied with 3B Torso Guide (page 48).
87x38x25 cm; 7.2 kg

9985-1000191

Female Deluxe Torso, 20-part

Additionally featuring:

- 2 lungs
 - Female chest wall
 - 3-part female genital insert with removable embryo
- Supplied with 3B Torso Guide (page 48).
87x38x25 cm; 7.2 kg

9985-1000185

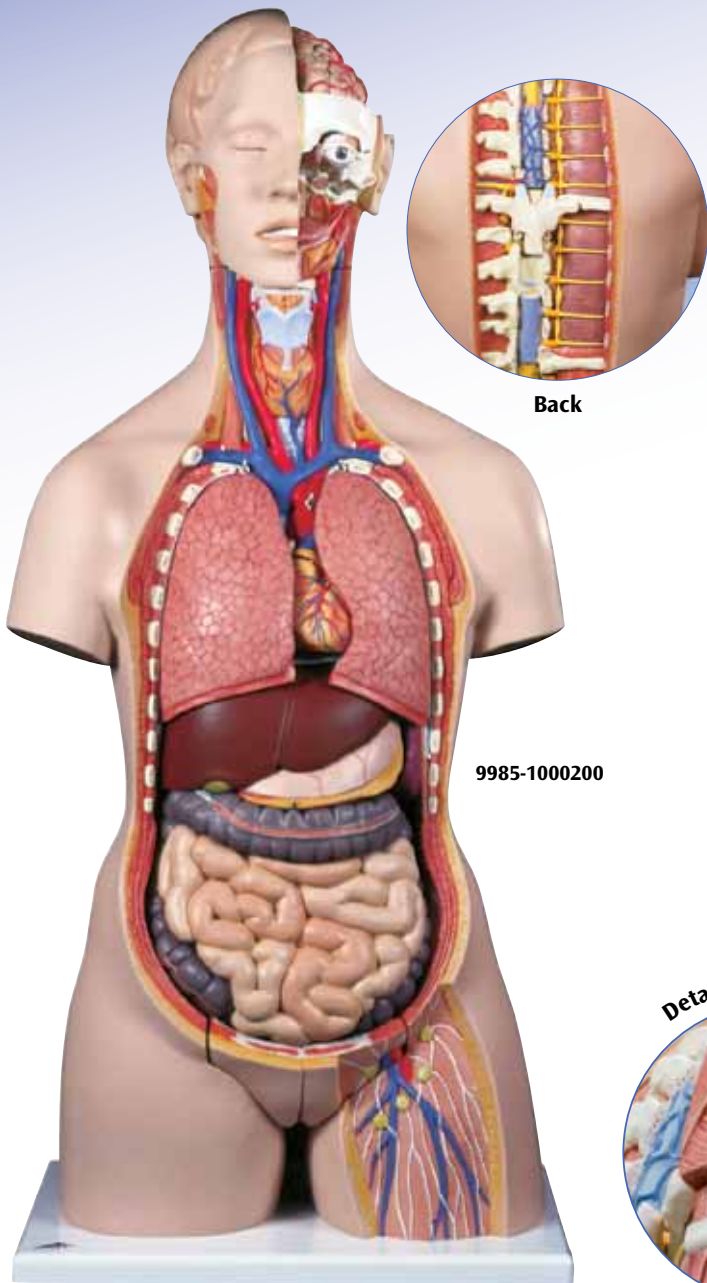

9985-1000200

Deluxe Dual Sex Torso with Opened Back, 28-part

This torso offers everything! Interchangeable male and female genital inserts, opened neck and back section to study vertebrae, intervertebral discs, spinal cord, spinal nerves, vertebral arteries etc., a deluxe head with a 4-part brain and much more. A detailed torso for advanced demonstrations. The following parts are removable:

- 7th thoracic vertebra,
- female chest wall
- 6-part head
- Female breast covering
- 2 lungs
- 2-part heart
- 2-part stomach
- Liver with gall bladder
- 4-part intestinal tract
- Front half of kidney
- 4-part male genital insert
- 3-part female genital insert with embryo

Supplied with 3B Torso Guide (page 48).
87x38x25 cm; 7.6 kg

9985-1000200

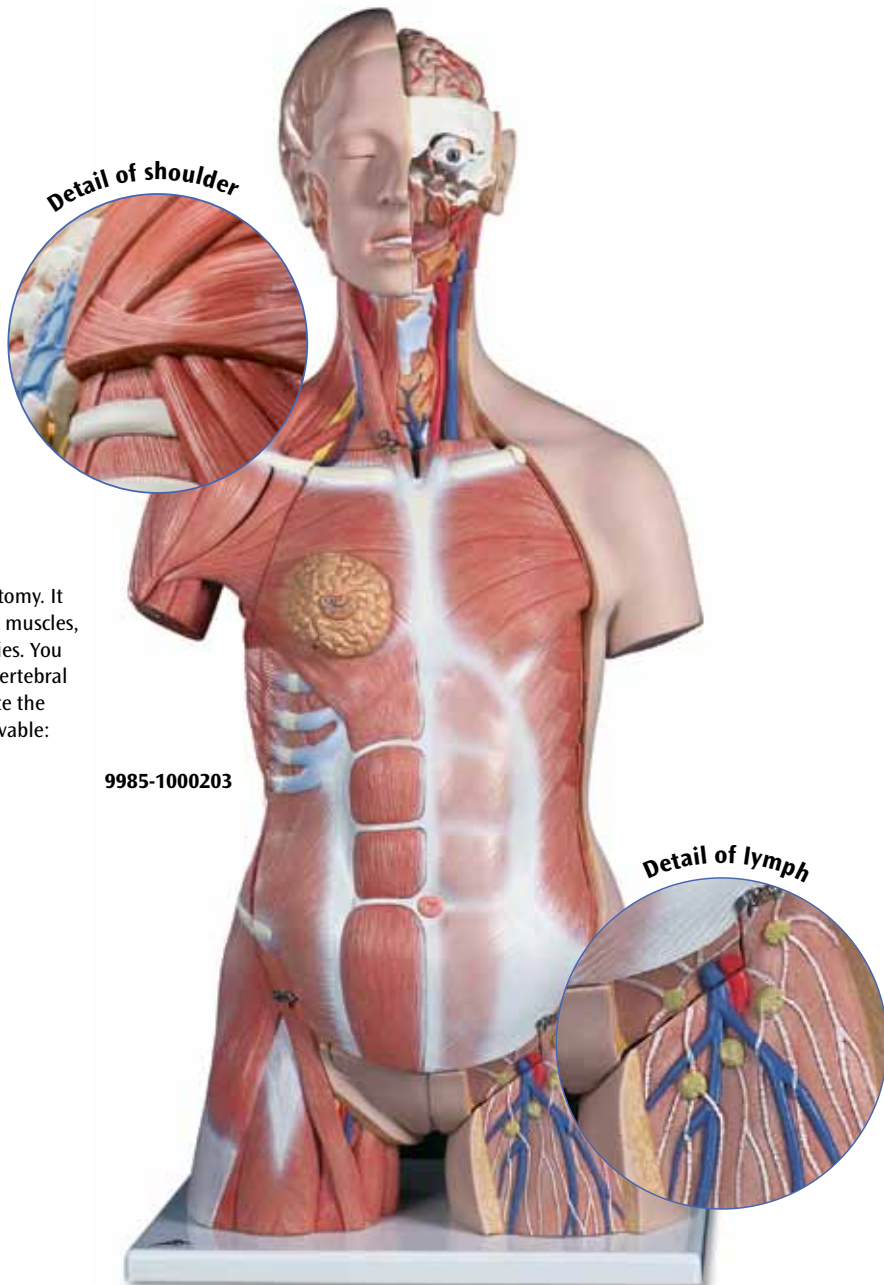

9985-1000203

Deluxe Dual Sex Muscle Torso, 31-part

With this unique torso you have the top notch in the field of anatomy. It depicts both the superficial and deep muscles, and the two main muscles, the deltoid and gluteus maximus can be removed for closer studies. You can also study the vertebrae, the spinal cord, spinal nerves and vertebral arteries, exchange the male and female genital inserts, investigate the internal structures of the brain etc. The following parts are removable:

- 6-part head
- Chest and abdominal wall with muscles
- 7th thoracic vertebra
- Female mammary gland
- Gluteus maximus and deltoid muscle
- 2 lungs
- 2-part heart
- 2-part stomach
- Liver with gall bladder
- 4-part intestinal tract
- Front half of kidney
- 3-part female genital insert with embryo
- 4-part male genital insert

Supplied with 3B Torso Guide (page 48).
87x38x25 cm; 8.5 kg

9985-1000203

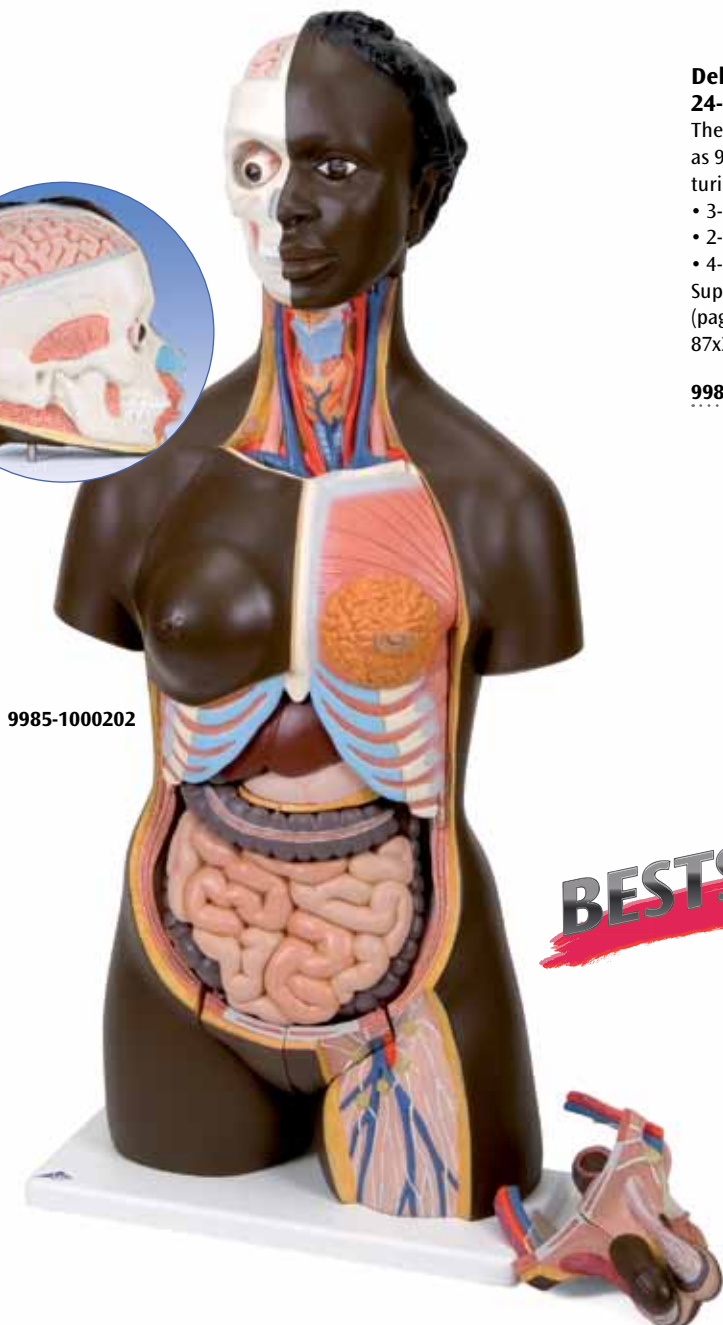

9985-1000202

Deluxe Dual Sex Torso, 24-part

The advanced torso version! Same as 9985-1000197, additionally featuring:

- 3-part head
- 2-part stomach
- 4-part intestinal tract

Supplied with 3B Torso Guide (page 48).

87x38x25 cm; 7.5 kg

9985-1000196

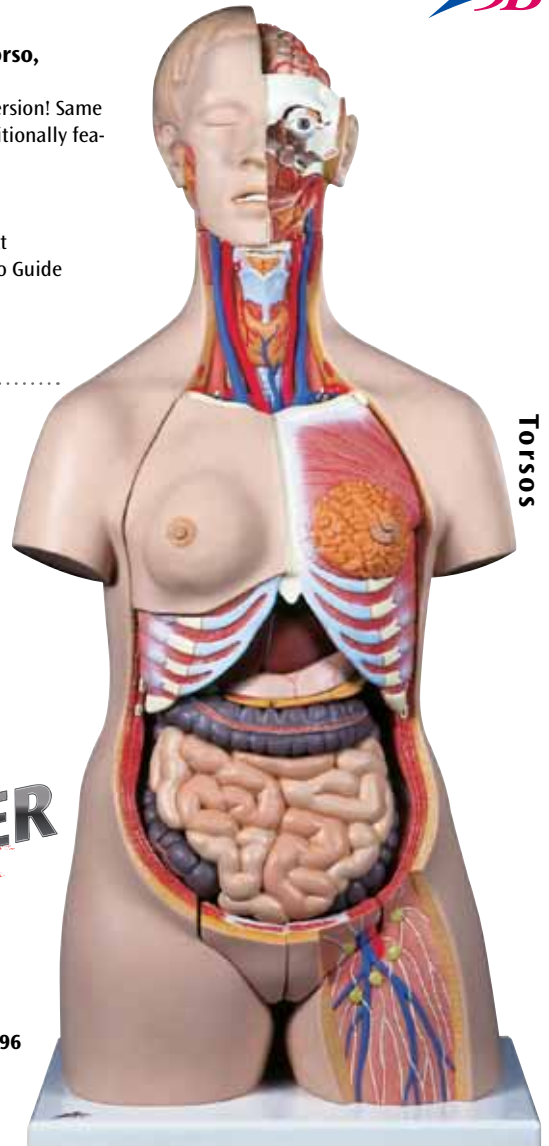

TORSOS

9985-1000196

BESTSELLER

African Dual Sex Torso, 24-part

Same as 9985-1000196.
87x38x25 cm; 7.5 kg

L/D/E/F/S/I/J/R/C www.3bscientific.com

9985-1000202

Asian and Japanese Dual Sex Torsos, 18-part

3B Scientific has developed two torsos especially for Asian schools. Both are judged as a "must" by the Japanese Ministry of Health for high quality education. Choose between general Asian or specifically Japanese facial features, the internal organs are soft and identical in both versions:

- Head
- 2 lungs
- 2-part heart
- Stomach
- Liver with gall bladder
- 2-part intestinal tract
- Front half of kidney
- 3-part female genital insert with embryo
- 4-part male genital insert

Supplied with 3B Torso Guide (page 48).

85x38x25 cm; 6,7 kg

Japanese Dual Sex Torso, 18-part

9985-1000199

Asian Dual Sex Torso, 18-part

9985-1000198



9985-1000199

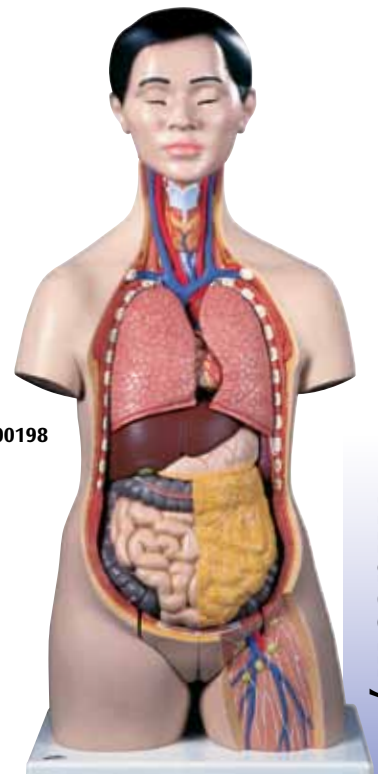

9985-1000198

Anatomy



9985-1000204

**Deluxe Dual Sex Torso with Muscular Arm, 33-part**

A unique feature of this life-size torso is the removable 6-part muscle arm. The high quality model therefore fully represents the anatomy of the complete human upper body. The right half shows the skin, the left half the superficial and deeper muscles with nerves, vessels and bony structures. The following parts are removable:

- 2-part head
- Brain half
- Sternocleidomastoideus muscle
- 6-part muscle arm, removable
- Upper leg stump
- Chest /abdominal wall with detachable mammary gland
- Torso body
- 2 lungs
- 2-part heart
- Liver with gall bladder
- 2-part stomach
- Kidney half
- 4-part intestinal tract
- 3-part female genital insert with embryo
- 4-part male genital insert

Supplied on base board and with 3B Torso Guide (page 48).

90x55x60 cm; 15.5 kg

 **L/D/E/F/S/P/J** in colour

9985-1000205

Asian Deluxe Dual Sex Torso with Muscular Arm, 33-part

Same as 9985-1000205, with Asian head.

9985-1000204



9985-1000205

Overview: Deluxe Torsos

Product Number	9985-1000185	9985-1000191	9985-1000196	9985-1000197	9985-1000198	9985-1000199	9985-1000200	9985-1000202	9985-1000203	9985-1000204	9985-1000205
Parts	20	20	24	20	18	18	28	24	31	33	33
Muscular arm	–	–	–	–	–	–	–	–	–	6-part	6-part
Open Back	–	–	–	–	–	–	yes	–	yes	–	–
Female Breast Covering	1-part	–	1-part	1-part	1-part	1-part	1-part	1-part	2-part	2-part	2-part
Head	3-part	3-part	3-part	2-part	1-part	1-part	6-part	3-part	6-part	3-part	3-part
Lung Halves	yes	yes	yes	yes	yes	yes	yes	yes	yes	yes	yes
Ribs Shown	yes	yes	yes	yes	yes	yes	yes	yes	yes	yes	yes
Heart	2-part	2-part	2-part	2-part	2-part	2-part	2-part	2-part	2-part	2-part	2-part
Stomach	2-part	2-part	2-part	1-part	1-part	1-part	2-part	2-part	2-part	2-part	2-part
Liver/Gall Bladder	yes	yes	yes	yes	yes	yes	yes	yes	yes	yes	yes
Intestine	4-part	4-part	4-part	2-part	2-part	2-part	4-part	4-part	4-part	4-part	4-part
Kidney Half	yes	yes	yes	yes	yes	yes	yes	yes	yes	yes	yes
Male Genitals	–	4-part	4-part	4-part	4-part	4-part	4-part	4-part	4-part	4-part	4-part
Female Genitals	3-part	–	3-part	3-part	3-part	3-part	3-part	3-part	3-part	3-part	3-part

Disc Torso, 15 slices

This unique torso is horizontally sectioned into 15 slices. The topographical relationships are represented as coloured reliefs on the individual sectional planes. For closer study, each disc can be shifted horizontally, rotated around its sagittal axis, and individually removed.

130x40x35 cm; 11.5 kg

L/D/E/F/S

9985-1001237

Mini Torso 12-part

This torso is approximately half life size. Even small hands can quickly disassemble it, removing:

- 2-head halves
- Brain half
- 2 lungs
- 2-part heart
- Stomach
- Liver with gall bladder
- 2-part intestinal tract

L/D/E/F

9985-1000195

Mini Torso without Head, 9-part (not shown)

Same features as 9985-1000195, but without a head.

42x24x18 cm; 1.9 kg

L/D/E/F

9985-1000194

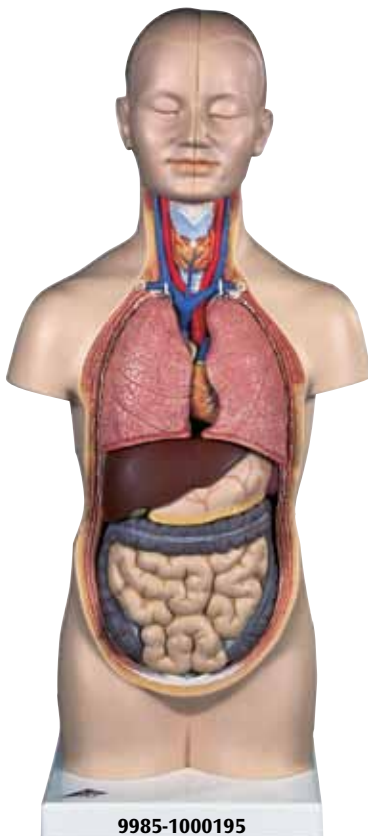

9985-1000195

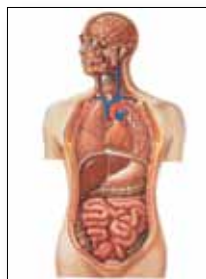

9985-4006519 –
9985-1001159 +

BESTSELLER



9985-1001237

Torsos

Anatomy

You will find our large selection of Charts starting on page 108.

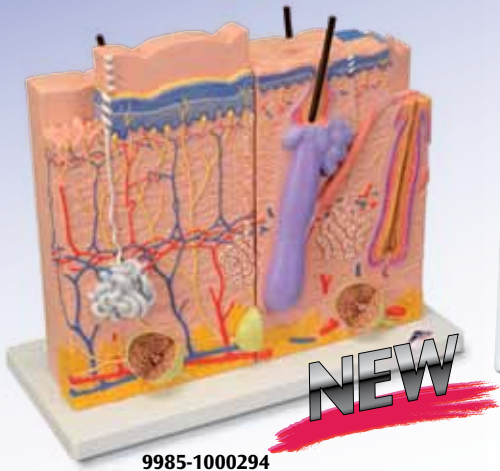

9985-1000294

3-part Skin Model

The model consists of three individual parts on a common stand that represent sections of the human skin with a magnification of 80x. Anatomical differences of the skin sections are didactically represented in an understandable manner. Microanatomical representation of the papillary layer (e.g. localised in the palm of the hand). Microanatomical representation of the reticular layer (e.g. localised at the back of the hand). Longitudinal section through the human scalp with hair follicle and root sheath. All layers making up the skin and microscopic structures such as nerve, vessels and tactile corpuscles have been accurately and spatially realised on the models. 34x29x15.5 cm; 2.05 kg
 L/E/D/S/F/P/J/C/R [www.](#)

9985-1000294

Skin, Block Model, 70 times full-size

This unique model shows a section of human skin in three dimensional form. Individual skin layers are differentiated, and important structures such as hair, sebaceous and sweat glands, receptors, nerves and vessels are shown in detail. Mounted on baseboard. 44x24x23 cm; 3.6 kg
 L/E/D/S/F/P/J [www.](#)

9985-1000291



9985-1000289

Skin Section, 70 times full-size

This relief model shows a section through the three layers of the hair-covered skin of the head. Delivered on base it shows:
 • Representation of hair follicles with sebaceous glands
 • Sweat glands
 • Receptors
 • Nerves
 • Vessels
 26x33x5 cm; 1.0 kg
 L/E/D/S/F/P/J [www.](#)

9985-1000289

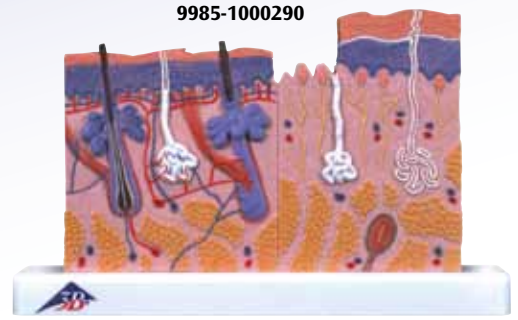

9985-1000290

Skin Section, 40 times full-size

The two halves of this relief model show the three layers of hairy and hairless skin in order to make the differences clear. In detail with hair follicles, sebaceous glands, sweat glands, receptor, nerves and vessels. Delivered on base. 24x15x3.5 cm; 0.2 kg
 L/E/D/S/F/P/J [www.](#)

9985-1000290

Skin Section

This model shows the microscopic structure of the skin in great detail. With the help of the different skin sections of the hairless skin (for example palm of hand) and the hairy skin (for example forearm) the different cell layers as well as the embedded sweat glands, touch receptor, blood vessels, nerves and a hair with root can be seen. Furthermore a nail section model on the base shows the nail plate, nail bed and the nail root. The representation of a hair root with all its cell layers completes the skin model. 10x12.5x14 cm; 0.35 kg
 L/E/D/S/F/P/J [www.](#)

9985-1000292

Human Skin Series with Burn Pathologies, 75 times life-size

Six models in one. The front face, compares and contrasts the normal healthy skin from three different body regions; the palm or sole (totally hairless), the axilla or armpit (sparsely endowed with hair), and the scalp (completely hirsute). The back of the model illustrates the progressive severity of injury caused by burns – from the painful reddening and transitory damage of the first degree burn, to the blistering, often permanent damage of the second degree burn, to the deep charring and permanent tissue destruction of the third degree burn. 46 features are coded for identification in accompanying key. Delivered on wooden stand. 46x25x8 cm; 2.75 kg
 E

9985-1005549



9985-1005549

6 Different Stages of Skin Cancer Model, enlarged 8 times

- Healthy
- Malignant cells are found at the surface, within the epidermis
- Malignant cells fill the epidermis, a few invade the papillary layer
- Malignant cells fill the papillary layer
- Malignant cells invade the reticular layer
- Malignant cells have reached the subcutaneous fatty tissue, satellite cells approach a vein

In the top view, the individual stages of externally visible skin changes are shown, allowing for an assessment according to the "ABCDE" criteria. The sides of the model show the various levels of invasion into the skin layers according to Clark (I-V) and the tumor thickness according to Breslow (in mm). 5 original colour illustrations on the base show various types of malignant melanomas. Mounted on a base. 14x10x11.5 cm; 0.2 kg
 L/E/D/S/F/P/J [www.](#)

9985-1000293

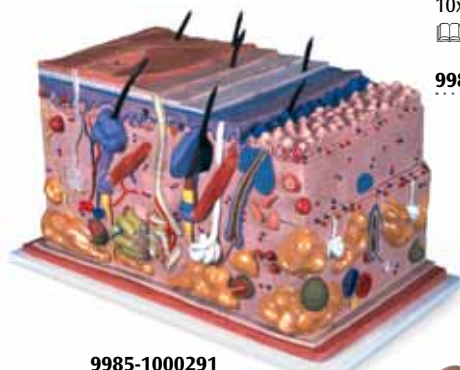

9985-1000291



9985-1000292



9985-1000293

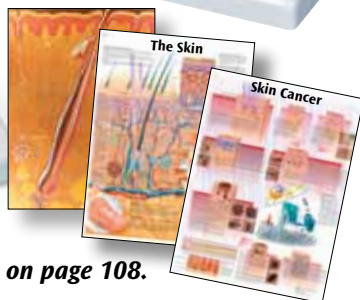

Charts starting on page 108.



Head with Neck, 4-part

The left half of this life-size model in midsagittal section shows the muscles, with nerves, vessels and bony structures and contains a removable brain half. The head is mounted on a detachable neck part which is sectioned both horizontally and diagonally. Supplied on baseboard.

28x19x23 cm; 2.2 kg

L/D/E/F/S/P/J [www.](http://www.3banatomy.com)

9985-1000216

Asian Deluxe Head with Neck, 4-part

Same as 9985-1000216, but with Asian features.

28x19x23 cm; 2.2 kg

L/E/D/S/F/P/J [www.](http://www.3banatomy.com)

9985-1000215



9985-1000217

9985-1000218



9985-1000220

9985-1000219

Head Model, 6-part

Our most detailed head model! This life-size 6-part head is mounted on a base and features a removable 4-part brain half with arteries. The eyeball with optic nerve is also removable and one side exposes the nose, mouth cavity, pharynx, occiput and skull base.

19x23x22 cm; 1.0 kg

L/D/E/F

9985-1000217

Head Model, 3-part

This life-size 3-part head is mounted on a stand and features a removable brain half with arteries, eyeball and optic nerve and one side which exposes the nose, mouth cavity, pharynx, occiput and skull base.

19x23x22 cm; 1.1 kg

L/D/E/F

9985-1000218

Median and Frontal Section of the Head

2 relief models on baseboard.

41x31x5 cm; 1.45 kg

L/D/E/F

9985-1000220

Median Section of the Head

This relief model shows all relevant structures of the human head in great detail. On baseboard.

26x33x5 cm; 1.0 kg

L/D/E/F

9985-1000219

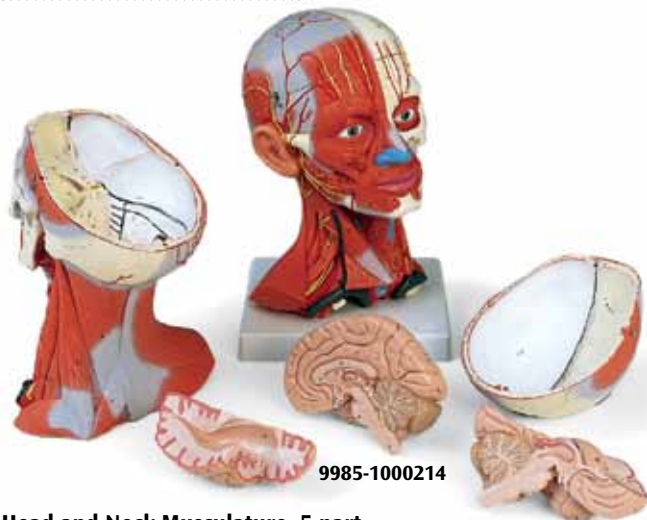

9985-1000214

9985-1000221

Head and Neck Musculature, 5-part

Representation of the superficial musculature and deep muscles, nerves and vessels. Dissectible into skull cap and 3-part brain. Delivered on removable baseboard.

36x18x18 cm; 1.8 kg

L/D/E/F/S/P/I/J [www.](http://www.3banatomy.com)

9985-1000214

Half Head with Musculature

Representation of the outer, superficial and the internal (median section) structures of head and neck. Delivered on removable stand.

22x18x46 cm; 1.1 kg

L/D/E/F

9985-1000221



9985-1001239

Head Musculature

Representation of the superficial musculature of head and neck showing:

- Parotid gland
- Submandibular gland (right half)
- Deep musculature (left half)
- Lower jaw partially exposed

L/D/E/F/S

9985-1001239



9985-1001240

Head Musculature with Blood Vessels

Same features as VD127. Additionally displaying blood vessels.

24x18x24 cm; 1.2 kg

L/D/E/F/S

9985-1001240



9985-1008543

Head Musculature with Nerves

Same features as 9985-1001239. Additionally displaying nerves.

24x18x24 cm; 1.2 kg

L/D/E/F/S

9985-1008543



9985-1008544

Median Section of the Head, 5-part

Relief model. Dissectible into:

- Tongue with sublingual gland and mouth floor musculature
- Thyroid cartilage with associated musculature
- Larynx
- Thyroid gland

2.5x23.5x27 cm; 1.2 kg

L/D/E/F/S

9985-1008544

Head and Neck, 5-part

Representation of the head (differentiated in colour), medially divided.

The skin and facial muscles of the right outer half are removed to show the deeper structures. Eyeball, bone cover over the sinus maxillaries and right tongue half are removable.

38x36x25 cm; 3.0 kg

E

9985-1005536



9985-1005536

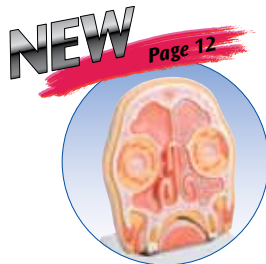

Art. No.	Description
9985-1000240	Lower Incisor, 2-part
9985-1000241	Lower Canine, 2-part
9985-1000242	Lower Single Root Pre-Molar
9985-1000243	Lower Twin-Root Molar Showing Caries Attack, 2-part
9985-1000244	Upper Triple Root Molar, 3-part



9985-1000241

9985-1000243

9985-1000244

9985-1000240

9985-1000242

9985-1000239

Classic Tooth Model Series, 5 models

This series shows 5 representative types of adult dentition individually mounted on removable stands:

- 2-part lower incisor with longitudinal section (9985-1000240)
- 2-part lower canine with longitudinal section (9985-1000241)
- Lower single root pre-molar (9985-1000241)
- 2-part lower twin root molar with longitudinal section showing caries attack (9985-1000243)
- 3-part upper triple root molar with longitudinal section and caries insert (9985-1000244)

Also available individually.

23 – 29 cm; 2.0 kg

L/D/E/F

9985-1000239

Dental Disease, magnified 2 times, 21 parts

With 16 removable adult teeth magnified two times. One half of the model shows eight healthy teeth and healthy gums. The other half of the model shows the following dental diseases:

- Dental plaque
- Dental calculus (tartar)
- Periodontitis
- Inflammation of the root
- Fissure, approximal and smooth surface caries.

One part of the front bone section can be removed to view the roots, vessels and nerves. Two molars are sectioned along the length to show the inside of the tooth.

Delivered on a base. 25.5 x 18.5 x 18cm; 0.6 kg

E/D/F/S/P/I/J www.3b.com

9985-1000016

9985-1000016



Giant Dental Care Model, 3 times life-size

This model, large enough to be seen from the back of a classroom, shows the upper and lower half of an adult's dentition. A flexible joint between the jaws allows easy movement. Teach children proper cleaning techniques using the giant toothbrush included with this model.

18x23x12 cm; 1.5 kg

9985-1000246

Replacement parts for 9985-1000246

Giant Toothbrush
36.5 cm

9985-4000098



9985-1000246

9985-4000098

9985-100540

9985-100545

9985-100546



9985-1008549

9985-1001251

9985-1000245



9985-1001252



Dental Morphology Series, 7-part, 10 times life-size

Removable lateral incisor, canine, first premolar, bridge made of artificial first molar with gold coloured crown, and second molar. All relevant structures are labelled. On transparent, jaw-shaped stand. 70x25.5x15 cm; 2.1 kg

Upper Incisor, 2-part

Complete horizontal section cut in order to show pulp. On removable base. 23 cm; 0.9 kg

L/D/E/F/S/P/I/J/R/C www.3b.com

9985-1008549

Upper Twin-Root Molar with Caries, 2-part

Half of tooth crown removable to show pulp and the onset of caries. On removable base. 23 cm; 0.9 kg

L/D/E/F/S/P/I/J/R/C www.3b.com

9985-1001252

Upper Triple-Root Molar with Caries, 2-part

Longitudinal section of tooth crown and root to show pulp and the onset of caries. On removable base. 23 cm; 1.1 kg

L/D/F/S/P/E/I/J/R/C www.3b.com

9985-1001251

Giant Molar with Dental Caries, 15 times life-size, 5-part

This model depicts an upper triple-root molar and separates into 5 parts. It features a longitudinal section through the crown, two roots and the pulp cavity. Contains removable pulp and three tooth inserts with different stages of advanced caries. On stand. 24 cm; 1.5 kg

L/D/E/F

9985-1000245

Art. No. Language

9985-1005545 German

9985-1005540 English

9985-1005546 French

You will find our large selection of Charts starting on page 108.



9985-4006672 *
9985-1001510 **





9985-1000249

Half Lower Jaw, 3 times full-size, 6-part

This model represents half of the lower left jaw of a young person. One section of bone is removable to expose the tooth roots, spongiosa, vessels and nerves. Canine and first molar are removable, and longitudinally sectioned. On stand.

35x18x36 cm; 1.2 kg

L/D/E/F

9985-1000249



9985-1001250

Half Lower Jaw, 3 times full-size, 11-part

The front section of bone and all the teeth are removable, one incisor is longitudinally sectioned. Nerves, blood vessels, the sublingual and submandibular glands are shown.

22x32x9 cm; 1.1 kg

L/D/E/F

9985-1001249

Advanced Half Lower Jaw with 8 diseased teeth, 19-part

The front section of bone and all the teeth are removable, one incisor is longitudinally sectioned. Nerves, blood vessels, the sublingual and submandibular glands are shown. The diseased teeth show various stages of caries from a small and easy-to-treat example on an incisor, through to advanced degradation of a molar, showing exposed root. Using this model it is simple to explain the necessity of good tooth care.

22x32x9 cm; 1.1 kg

L/D/E/F

9985-1001250

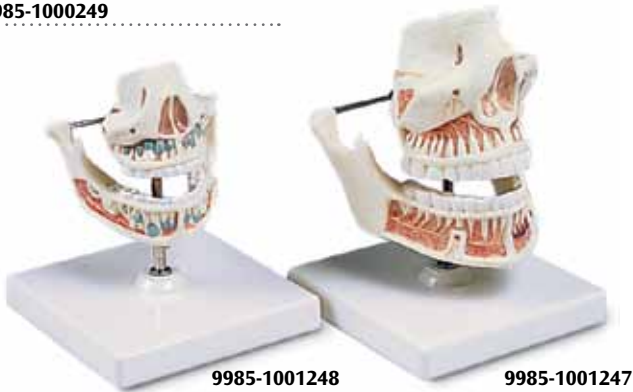

9985-1001248

9985-1001247

Milk Dentures

Upper and lower jaw are opened to show the arrangement of the remaining teeth. On base.

13x12x13 cm; 0.6 kg

L/D/E/F/S

9985-1001248

Adult Dentures

Tooth roots, spongiosa, vessels, and nerves are exposed. The lower jaw is movable. On base.

16x12x13 cm; 0.9 kg

L/D/E/F/S

9985-1001247



9985-1000248

Dentition Development

Cast from a natural specimen, 4 upper and lower jaw halves, 4 different stages of development:

- New born
- Approx. 5-year old child
- Approx. 9-year old child
- Young adult

33x10x20 cm; 0.5 kg

L/D/E/F

9985-1000248

3B MICROanatomy™ Tongue

The latest model in our 3B MICROanatomy™ series, the tongue, is fascinating because it combines enlargements of various different parts of the tongue in one model. It comprises a macroscopic view of the tongue in life size (dorsal view) and microscopic views of the various papillae of the tongue (10-20x life size) and of a taste bud (approx. 450x life size). All views are mounted on a base that also features an overview of the sensory and sensitive innervation of the tongue. A unique model for an intensive study of the tongue.

14,5x32,5x20 cm, 0,8 kg

L/D/E/F/I/S/P/J/R/C www.

9985-1000247



9985-1000247

Tongue Model, 2.5 times life-size, 4-part

This model shows the right sublingual and submandibular gland.

On removable base.

23x17x16 cm; 0.8 kg

9985-1002502

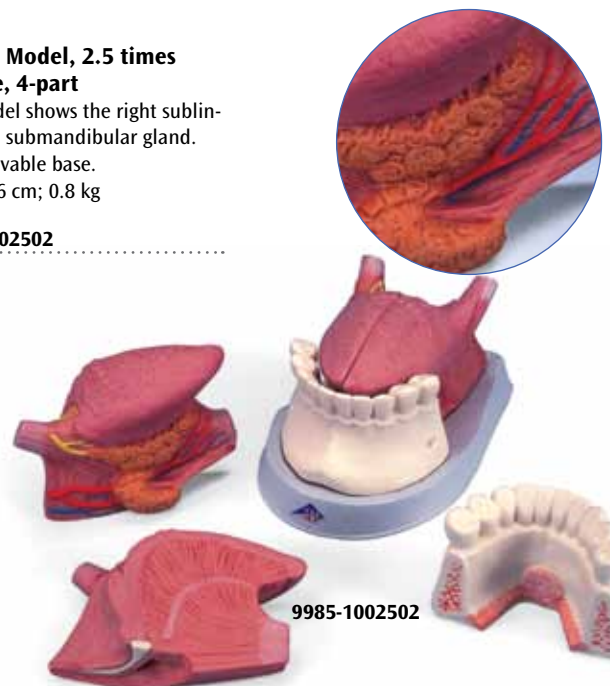

9985-1002502

Brain, 4-part

This brain is medially divided. All structures are hand-painted, numbered and identified in a product manual. The right half can be disassembled into:

- Frontal with parietal lobes
- Brain stem with temporal and occipital lobes
- Half of cerebellum

On removable base.
14x14x17.5 cm; 0.9 kg

L/D/E/F/S/P/I/J [www.](http://www.3b.com)

9985-1000224



9985-1000224

BESTSELLER
Brain

Brain, 8-part

A very detailed model of the human brain which is medially divided. Both halves can be disassembled into:

- Frontal with parietal lobes
- Temporal with occipital lobes
- Half of brain stem
- Half of cerebellum

On removable base.
14x14x17.5 cm; 0.9 kg

L/D/E/F/S/P/I/J [www.](http://www.3b.com)

9985-1000225

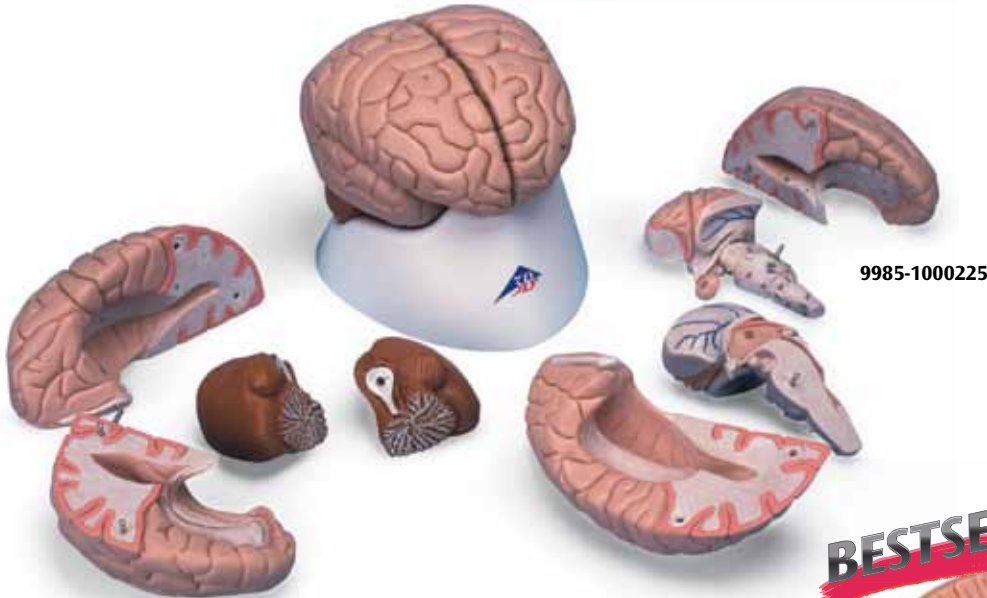

9985-1000225

BESTSELLER

Brain, 2-part

A medially divided brain, perfect for beginning studies because of its affordable price. Delivered on removable base.

15x14x17.5 cm; 0.7 kg

L/D/E/F/S/P/I/J [www.](http://www.3b.com)

9985-1000222

Introductory Brain, 2-part

This brain is medially divided, structures are shown in one colour. On removable base.

15x14x17.5 cm; 0.7 kg

9985-1000223



9985-1000222

9985-1000223



9985-1000226

9985-1000226
disassembled

Classic Brain, 5-part

This midsagittally sectioned model is an original anatomic cast of a real human brain. The components of its left half are:

- Frontal and parietal lobe
- Temporal and occipital lobe
- Encephalic trunk
- Cerebellum

Matches skull models 9985-1000046, 9985-1000050, 9985-1000050, 9985-1000052, 9985-1000053, 9985-1000054, 9985-1000055, 9985-1000056.

On removable base.
13x14x17.5 cm; 0.49 kg

L/D/E/F/S/P/I/J [www.](http://www.3b.com)

9985-1000226

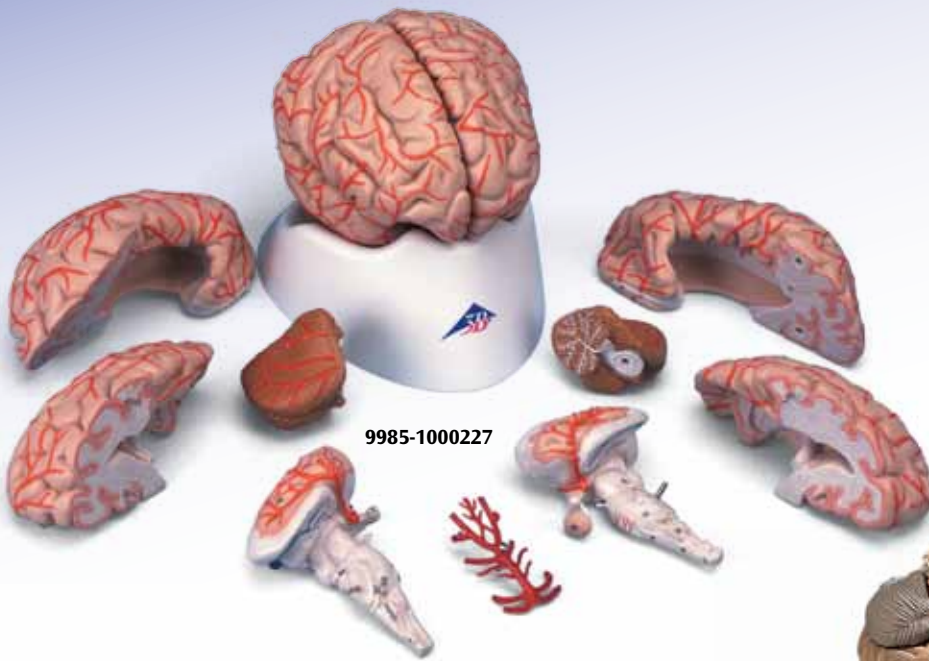

9985-1000227

Brain with Arteries, 9-part

This medially divided deluxe brain model shows the brain arteries as well as the removable basilar artery. Both halves can be disassembled into:

- Frontal with parietal lobes
- Temporal with occipital lobes
- Half of brain stem
- Half of cerebellum

On removable base.

15x14x16 cm; 0.9 kg

L/D/E/F/S/P/I/J [www.](http://www.3BScientific.com)

9985-1000227

Brain with Arteries on Base of Head, 8-part

This 9985-1000227 deluxe brain comes with opened head to allow detailed study of the brain's position in the skull. The head is horizontally divided above the skull base. The deluxe brain model is medially opened to show the brain arteries. Both halves can be disassembled into:

- Frontal with parietal lobes
- Temporal with occipital lobes
- Brain stem
- Cerebellum

On base.

15x15x23 cm; 1.6 kg

L/D/E/F/S/P/I/J [www.](http://www.3BScientific.com)

9985-1000229



9985-1000229



9985-1008552

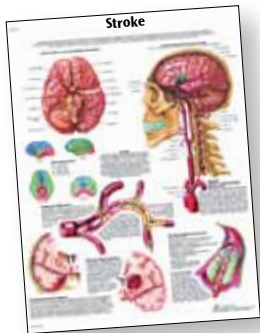

9985-4006712 *

9985-1001590 **

**Neuro-Anatomical Brain, 8-part**

This deluxe brain is medially divided. On the right half, you will find a coloured, systematic grouping and representation of the cerebral lobe. The left half shows:

- Pre and post-central region
- Broca and Wernicke areas
- Heschl's gyrus
- Brain nerves
- Ventricles

Both halves can be disassembled into:

- Frontal with parietal lobes
- Temporal with occipital lobes
- Half of brain stem
- Half of cerebellum

On removable base.

14x14x17.5 cm; 0.95 kg

L/D/E/F

9985-1000228

Brain with Arteries, 5-part

Medially divided with the right half showing arteries. The left half can be disassembled into:

- Frontal with parietal lobes
- Temporal with occipital lobes
- Half of brain stem
- Half of cerebellum

On removable stand.

15.5x13x15 cm; 1.0 kg

L/D/E/F/S

9985-1008552



9985-1000228

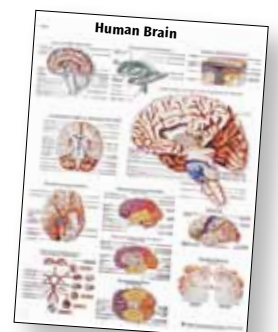

9985-4006709 *

9985-1001584 **

Giant Brain, 2.5 times full size, 14-part

A comprehensive brain model that is also a very useful teaching aid, especially for large groups of students. All structures of the brain and the ventricles are visible through median, frontal and horizontal sections. Delivered on removable base.

34x30x37 cm; 5.6 kg

L/D/E/F/S

9985-1001261



9985-1001261

Brain



9985-1005555

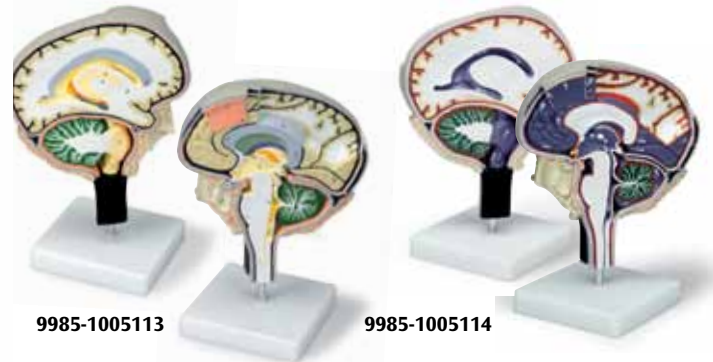

9985-1005113

9985-1005114

Regional Brain, 4-part

The following lobes and regions of this 2-times life-size brain are represented in different colours and labeled in English:

- Frontal lobe
- Parietal lobe
- Occipital lobe
- Temporal lobe
- Motor cortex
- Somatosensory cortex
- Limbic cortex
- Cerebellum
- Brain stem

The twelve cranial nerves and additional features are numbered. Supplied with wooden stand.

23x20x30 cm; 2.38 kg

E

9985-1005555

Brain Ventricle

This model shows both side ventricles, the 3rd and 4th ventricle and the Aquaeductus cerebri (Sylvius). On stand.

14x11x14 cm; 0.6 kg

L/D/E/F/S/P/I/J www.3b.com

9985-1001262



9985-1001262

Brain Section

An enlarged and very detailed section through the right half of the brain, including a portion of the skull. The pia mater has been removed. This model is double sided and finely coloured. One surface is on the median line, including a section of the falx cerebri. A sagittal cut on the reverse exposes the lateral ventricle. There are 49 references on the model, identified in English in an accompanying key card. Mounted on a stand.

25x18x12 cm; 0.9 kg

E

9985-1005113

Cerebrospinal Fluid Circulation

Enlarged, detailed model of a section through the right half of the brain showing the cut pia mater, arachnoid and dura mater. The model has the cerebrospinal fluid areas clearly identified and the direction of flow indicated by arrows. Bright colours to distinguish important features; identified in English in an accompanying key card. Mounted on stand.

25x18x12 cm; 0.9 kg

E

9985-1005114

Rat Brain Comparative Anatomy

The model shows a rat brain in approx. 6-fold enlargement. Sectioned medially, it can be disassembled into two halves. The right half of the model shows the structures of the cerebrum, cerebellum and brain stem, each of which is colour-coded for didactic purposes (cerebrum = pink, cerebellum = blue, brain stem = yellow), both externally and in the median section. The left half of the model is largely transparent, thus revealing a view of the coloured left lateral ventricle and hippocampus, which can also be seen in the median section. For purposes of comparison, a natural cast of a rat brain and a didactic, small-scale illustration of a human brain in median section are shown on the base, with the same colour coding used for the various regions.

14x10x16 cm; 0.24 kg

L/D/E/F/S/P/I/J www.3b.com

9985-1000230



9985-1000230



9985-4006536 –
9985-1001185 +

Anatomy



9985-1000233 “Physiology of Nerves” Series, 5 Magnetic Models on Illustrated Metal Board

Displaying the basic structures of the human nervous system. Each of the five sections shows a plastic coloured relief model of the main synapse variations. All sections can magnetically attach to the illustrated base which depicts the neural components in vivid colours. Each section is also available separately.

9985-1000234

68x51x10 cm; 4.2 kg
E/D/S/F/P [www](#).

9985-1000235

9985-1000232

9985-1000232

9985-1000237

9985-1000236



Neuron Cell Body

Typical neuron body with cell organelles, for example mitochondria and many other characteristics of human cell, are visible through a removable transparent cover. The edge of the cell body also shows the synapses of connected neurons.

12.2x11.7x6.2 cm; 0.2 kg

9985-1000233

Myelin Sheaths of the CNS

This model shows the glial cells which build the insulating layer around the axons of the central nervous system.

12.2x11.7x3.6 cm; 0.2 kg

9985-1000234

Schwann Cells of the PNS

Depicts a Schwann cell with sectioned core.

12.2x11.7x3.2 cm; 0.2 kg

9985-1000235

Motor End Plate

Neuromuscular junction with striated muscle fibre is depicted.

12.0x11.5x3.2 cm; 0.2 kg

9985-1000236

Synapse

Featuring the endoplasmic reticulum, mitochondria and the membranes of the synaptic gap. Also depicts 5 smaller relief models of the main synapse variations.

12.0x11.5x2.7 cm; 0.2 kg

9985-1000237



9985-1000238

Spinal Cord with Nerve Endings

The model illustrates the composition of the spinal cord, magnified to a scale of about 5:1. The spinal cord is formed by a central channel surrounded by “grey matter” with an outer layer of “white matter”. The base features illustrations of various cross sections through the white and grey matter at the neck, torso, lumbar and sacral regions. Supplied on a base.

26x19x13 cm, 0.4 kg

L/D/E/S/F/P/I/J [www](#).

9985-1000238

Motor Neuron Diorama

Magnified more than 2,500 times, this model represents a fully three dimensional reproduction of a motor nerve cell situated within a milieu of interacting neurons and a skeletal muscle fibre. The membranous envelope has been cut away from the neuron to expose the cytological ultrastructure, organelles and inclusions within the cell body. Branching dendrites, communicating synapses and a myelin wrapped axon with node of Ranvier, project from the neuronal surface. A section of the axon lifts off to let you view the tightly wound layers of the enveloping myelin sheath and neurolemma, as well as the Schwann cell which formed them.

Mounted on a wooden base.

43x20x28 cm; 3.0 kg

E

9985-1005553

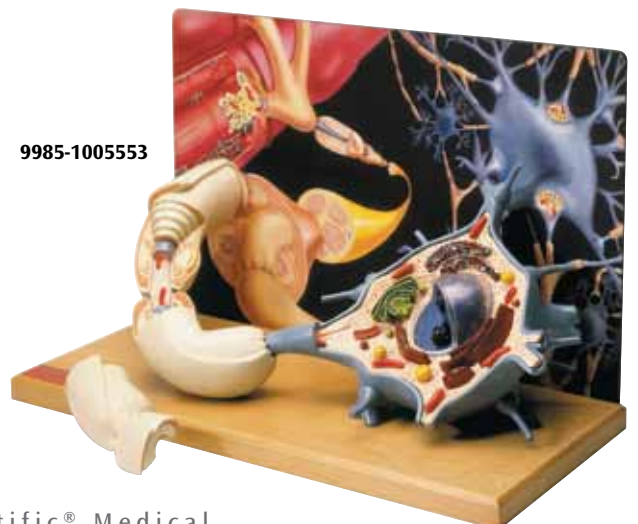

9985-1005553

Spinal Cord, 6 times full-size
 This model shows a segment of the upper thoracic spinal cord, laterally and longitudinally divided showing spinal nerve roots. Supplied on baseboard.
 35.5x27x27 cm; 0.75 kg
E

9985-1005530

Nervous System, 1/2 life-size
 This relief model shows a schematic representation of the central and peripheral nervous system. An excellent model to study the structure of the human nervous system. Supplied on baseboard.
 80x33x6 cm; 3.5 kg
L/E/D/S/F/P/I/J [www.](http://www.3b.com)

9985-1000231



9985-1000231



9985-1005530

You will find our large selection of Charts starting on page 108.

The Vegetative Nervous System
 9985-4006708 *
 9985-1001582 **

Nervous System
 9985-4006710 *
 9985-1001586 **

Spinal Nerves
 9985-4006711 *
 9985-1001588 **

9985-4006539 –
 9985-1001190 +

9985-4006540 –
 9985-1001192 +

Eye, 5 times full size, 6-part

Removable parts include:

- Upper half of the sclera with cornea and eye muscle attachments
- Both halves of the choroid with iris and retina
- Lens
- Vitreous humour

On base.

13x14x21 cm; 0.6 kg

L/E/D/S/F/P/I/J [www.](http://www.3b.com)

9985-1000255

BESTSELLER



9985-1000256



9985-1000255

9985-1000257

Eye, 5 times full size, 7-part

On base of bony orbit.

Same features as 9985-1000255.

18x18x20 cm; 1.0 kg

L/E/D/S/F/P/I/J [www.](http://www.3b.com)

9985-1000256

Eye, 5 times full size, 8-part

Shows eyelid, lachrymal system, and other features around the eyeball, otherwise the same as 9985-1000255. On base of bony orbit.

20x18x21 cm; 1.2 kg

L/D/E/F

9985-1000257

BESTSELLER



9985-1000259 Eye, 3 times full size, 6-part
 This model dissects into:

- Both halves of sclera with cornea and eye muscle attachments
- Both halves of the choroid with iris and retina
- Lens
- Vitreous humour

On base. 9x9x15 cm; 0.1 kg
 L/E/D/S/F/P/I/J [www.](http://www.3BScientific.com)

9985-1000259



9985-1000258

Eye, 5 times full size, 6-part
 Removable are:

- Upper half of the sclera with eye muscle attachments
- Upper half of the choroids with iris and retina
- Cornea
- Lens
- Vitreous humour

On base. 20x14x14 cm
 L/E/D/S/F/P/I/J/R/C [www.](http://www.3BScientific.com)

Eye, 3 times full size, 7-part
 As 9985-1000259, but additionally with the optic nerve in its natural position in the bony orbit of the eye (floor and medial wall). On base.
 18x26x19 cm; 1.1 kg
 L/D/E/F

9985-1000258

9985-1001265



9985-1001265

Eye in Orbit, 3.5 times full size, 8-part
 This model shows the eye with optic nerve in its position in the bone orbit (floor and medial wall). Dissectible into:

- Both halves of the sclera with optic nerve and eye muscles
- Cornea
- Lens
- Vitreous humour
- M. rectus superior
- M. rectus lateralis

On base.
 19x20x28 cm; 1.5 kg
 L/D/E/F/S

9985-1001263



9985-1001263



Physical Eye Model

This model can be used to demonstrate the optical functions of the eye, e.g. representation of an object on the retina, accommodation (change in the lens curvature), short sightedness and far sightedness.

The model comprises:

- Half eyeball with adjustable iris diaphragm, lens holder and 2 convex lenses (f = 65 mm and 80 mm), on a rod
- Half eyeball with retina (transparent screen), on a rod
- Lens holder with one concave and one convex corrective lens, on a rod
- Candle holder with 2 candles, on a rod
- Aluminium rail, 50 cm long, with 4 clamp slides
- Storage case

49x5.5x18 cm; 2.0 kg

D

9985-1003806

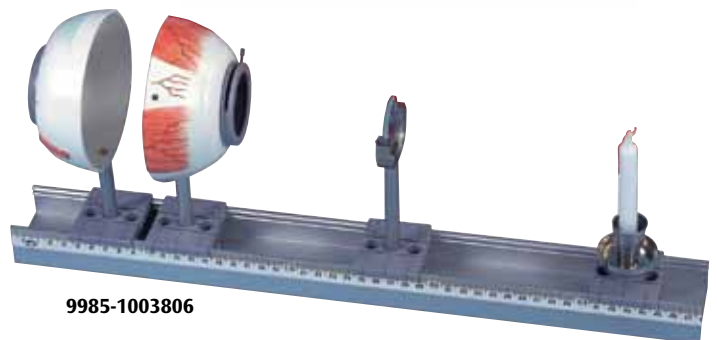

9985-1003806



Functional Eye

With this model the functions of the human eye can be taught very effectively. By moving the retina, the shape of the eye can be changed. The lens and ciliary body are made of silicone to allow the change of form and thickness of the lens. Pictures can be projected on the retina that allows you to demonstrate:

- Accommodation of the lens
- Near point of vision
- Myopia (near sightedness)
- Hypermetropia
- Presbyopia
- How to correct these problems with glasses

Supplied with detailed instruction manual.

45x30 cm; 2.0 kg

E

9985-1005046

9985-1005046



9985-1005047

Functional Eye – Small Version

Same features as model 9985-1005046.

32x18 cm; 1.5 kg

E

9985-1005047

3B MICROanatomy™ Eye

This model illustrates the microscopic structure of the retina with choroid and sclera. The left block like, layered side of the model side shows the complete structure of the retina including the vascular layer and parts of the sclera from a light microscopic view. The right part of the model is a sectional enlargement. It shows the microscopic structure of the photoreceptors and the cells of the pigmented layer.

25x23x18.5 cm; 1.2 kg

L/D/E/F/S/P/I/J www.3b.com

9985-1000260

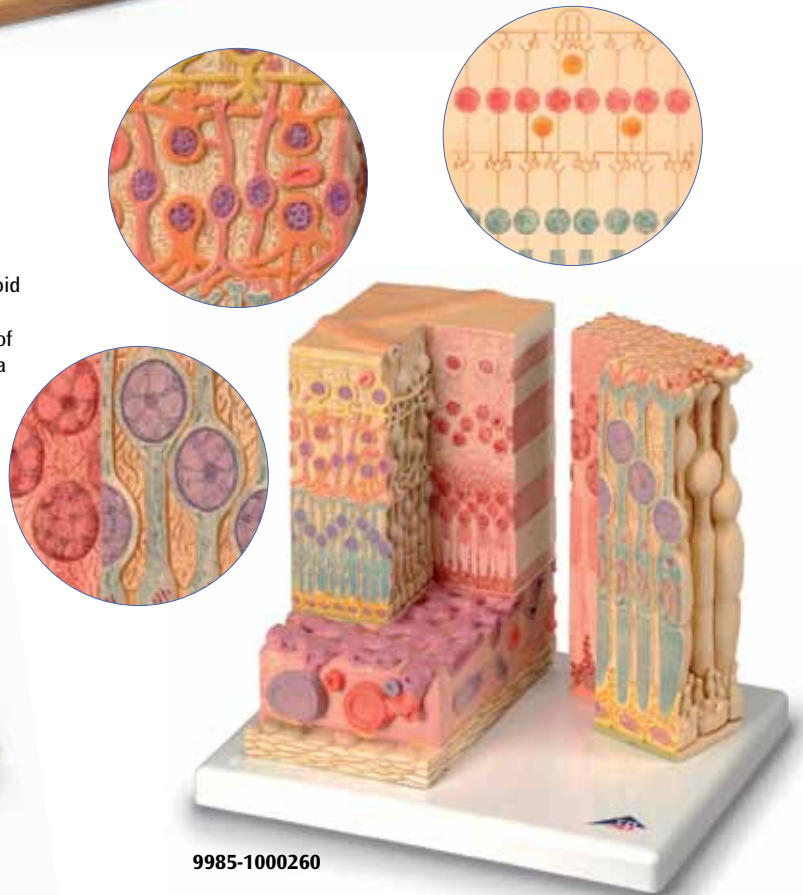

9985-1001264

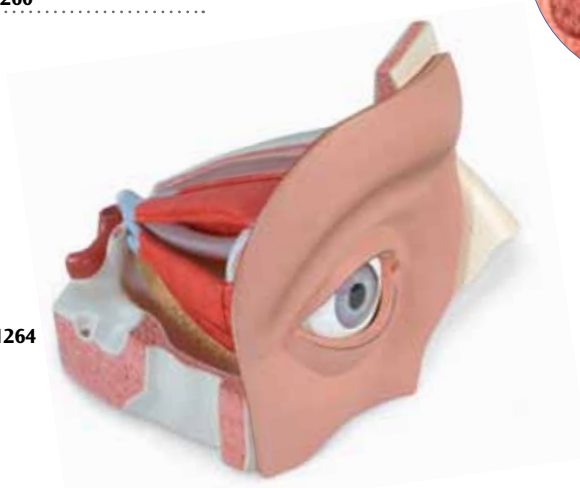

Eye, 5 times full size, 12-part

- Both halves of the sclera
- Optic nerve
- M. rectus superior
- M. rectus lateralis
- Cornea half
- Lens
- Lachrymal system
- Vitreous humour
- Tear gland
- Associated structures

33x30x38 cm; 4.9 kg

L/D/E/F/S

9985-1001264

You will find our large selection of Charts starting on page 108.

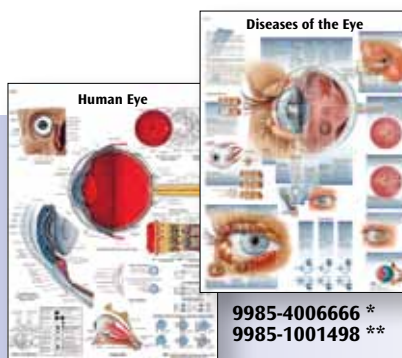

9985-4006665 *
9985-1001496 **



9985-4006521 –
9985-1001163 +

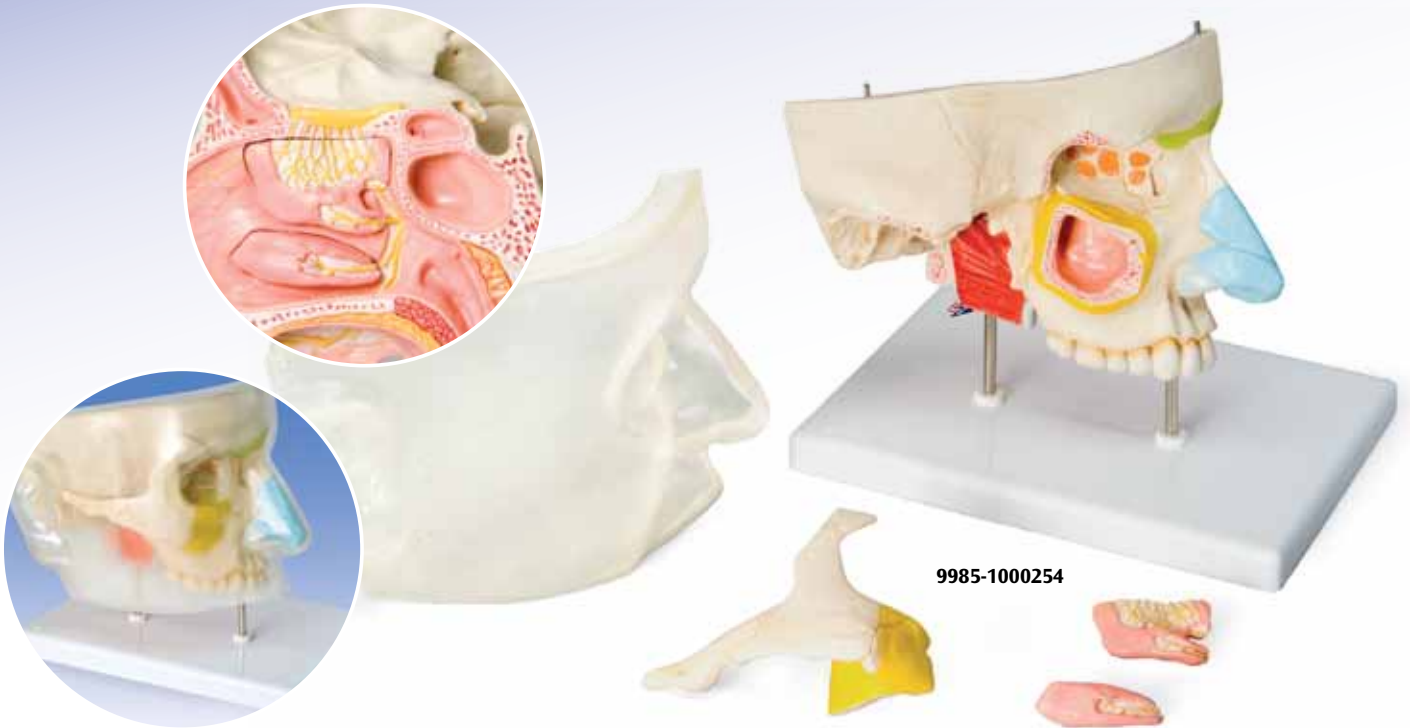

9985-1000254

Nose with Paranasal Sinuses, 5-part

This model illustrates the structure of the nose with the paranasal sinuses in the upper right half of a face in 1.5 times enlargement. The following structures can be seen from the outside, differentiated by colour (also visible through the removable transparent skin):

- The outer nasal cartilages
- The nasal, maxillary, frontal and sphenoidal sinuses
- The opened maxillary sinus when the zygomatic arch is removed

The following structures are shown in a median section:

- The nasal cavity, lined with mucosa, with the nasal conchae (removable)
- The arteries of the mucous membrane
- The olfactory nerves
- The innervation of the lateral wall of the nasal cavity, the nasal conchae and the roof of mouth (palate)

L/D/E/F/S/P/I/J www.3b.com

9985-1000254

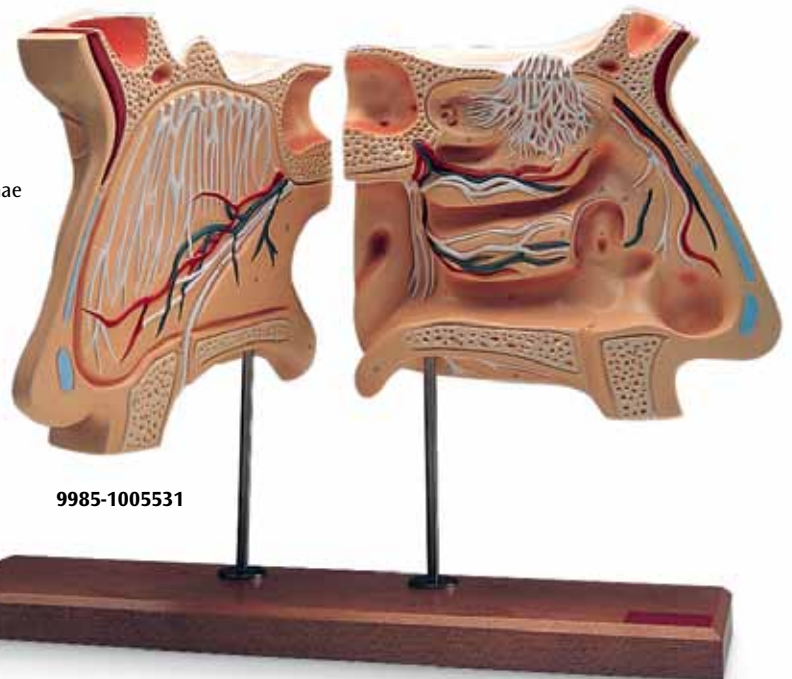

9985-1005531

Nose and Olfactory Organ, 4 times full-size

The nose halves are medially divided, from the base of the skull to the gum. This model shows the nasal septum with vessels and nerves (right side), all structures of the inner nasal cavity (left side), sinus and the opening of the Eustachian tube (left side). Parts are numbered and described on the outside. On a rotating base.

41x25.5x18 cm; 3.0 kg

E

9985-1005531

*You will find
our large selection
of Charts starting
on page 108.*

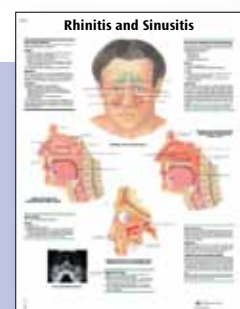

9985-406669 *
9985-1001504 **



9985-1001266



The World's Largest Ear Model, 15 times full size, 3-part

At 15 times life-size, this 3-part ear is suitable for museums and special collections as well as large lecture halls and conferences. Representation of outer, middle and inner ear. The auditory ossicles and the labyrinth with cochlea and vestibulocochlear nerve can be removed and studied in detail. On base.

130x120x60 cm; 52 kg

L/E/D/S/F/P/I/J www.3b.com

9985-1001266

Giant Ear, 5 times full size, 3-part

This version is a whopping 5 times life-size for easy viewing from anywhere in the classroom! Representation of outer, middle and inner ear. Removable auditory ossicles and labyrinth with cochlea and vestibulocochlear nerve. Delivered on base.

25x41x25 cm; 3.0 kg

L/D/E/F/S

9985-1008553



9985-4006670 *
9985-1001506 **

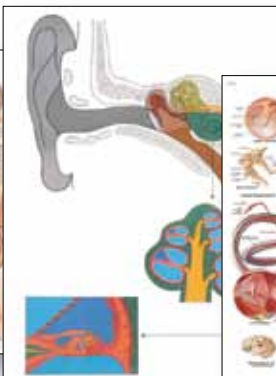

9985-4006520 -
9985-1001161 +



9985-4006667 *
9985-1001500 **



9985-1008553

BESTSELLER

Ears



9985-1000250



Ear, 3 times life size, 4 part
Representation of outer, middle and inner ear. Removable eardrum with hammer, anvil and stirrup as well as 2-part labyrinth with cochlea and auditory /balance nerve. On base.
34x16x19 cm; 1.25 kg
L/E/D/S/F/P/I/J www.

9985-1000250

Lifeize Auditory Ossicles

The human auditory ossicles, both individually and connected in natural position, embedded in transparent plastic.

9985-1000253



9985-1000253

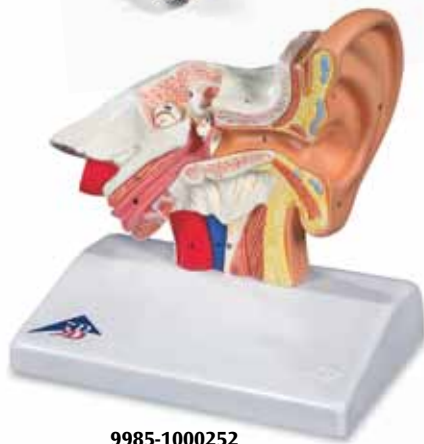

9985-1000252

Desktop Ear Model, 1.5 times enlarged

Representation of the outer, middle, and inner ear. On base. 14x10x14.7 cm; 0.35 kg
L/E/D/S/F/P/I/J www.

9985-1000252

Ear, 5 times full size, 8-part

Representation of outer, middle and inner ear. Removable are:

- Outer ear
- Petrosal bone
- Mastoid process
- Tympanic membrane and auditory ossicles
- Labyrinth
- Cochlea and vestibulocochlear nerve (3-part)

The transparent semicircular canals are filled with fluid, each with one bubble to demonstrate their balance function. On wooden base. 43x25.5x20 cm; 4.1 kg

E

9985-1005538



9985-1005538

Ear, 3 times life size, 6 part

Same as 9985-1000250, additionally with two removable bone sections to close the middle and inner ear. On base. 34x16x19 cm; 1.55 kg
L/E/D/S/F/P/I/J www.

9985-1000251



9985-1000251

Functional Ear Model

This model shows how the tympanic membrane, ossicles, the complex internal ear with the cochlea and the oscillations of the basilar hearing membrane operate /interact. The enclosed mirror enables operation of the model for the studying of various ear functions from different angles at the same time. One single model may be studied by several students simultaneously in an action oriented learning situation. Includes a four colour explanatory chart.

30x20x15 cm; 1.0 kg

E

9985-1005052



9985-1005052

NEW Page 12



Anatomy



9985-1000272

Larynx, 2 times full size, 7-part

This medially sectioned model shows:

- Larynx
- Hyoid bone
- Windpipe
- Ligaments
- Muscles
- Vessels
- Nerves
- Thyroid gland

Thyroid cartilage, 2 muscles and 2 thyroid gland halves are removable. On stand.

12x12x23 cm; 0.8 kg

[L/E/D/S/F/P/I/J](#) [www](#).

9985-1000272

9985-1000273



Larynx, 2-part

This model shows most of the same features as 9985-1000272, but it is only divisible into two halves.

On stand.

9x9x14 cm; 0.15 kg

[L/E/D/S/F/P/I/J](#) [www](#).

9985-1000273

Functional Larynx, 4 times full-size

Replica of the human larynx, hyoid bone and epiglottis. The right half shows cartilaginous structures, the left half of the musculature. Vocal cords, arytenoid cartilage and epiglottis are movable. On base.

41x18x18 cm; 1.6 kg

[E](#)

9985-1005528

NEW Page 12



9985-1005528

Larynx with Bronchial Tree and Transparent Lungs

This unique model was created on the basis of computer tomography data of a human (male, approx. 40 years). What is special about this procedure is that the natural spatial 3D relationships and the reciprocal location of the segmental bronchi can be preserved and depicted in a realistic way. The larynx with hyoid bone and epiglottis and the trachea with primary and lobar bronchi are shown in one colour. The larynx is detachable at the level of the second tracheal cartilage and divisible in the median plane. The epiglottis is mounted flexibly. The various segmental bronchi are made of elastic material and detailed in various transparent colours so that they are easier to distinguish visually. The transparent lungs are detachable.

19x18x37 cm; 1.3 kg

[E/D/S/F/P/I/J](#) [www](#).

9985-1000275



9985-1000271

Functional Larynx, 2.5 times full size

The epiglottis, vocal cords and arytenoid cartilage are movable. Additionally representing the following structures:

- Hyoid bone
- Cricoid cartilage
- Thyroid cartilage
- Thyroid
- Parathyroid glands

On stand.

14x14x28 cm; 0.8 kg

[L/E/D/S/F/P/I/J](#) [www](#).

9985-1000271



9985-1001242

Functional Larynx, 3 times full size

Epiglottis, vocal cords and arytenoid cartilage are movable. On base.

32x13x15 cm; 0.8 kg

[L/E/D/S/F/P/I/J](#) [www](#).

9985-1001242

CT Bronchial Tree with Larynx

Same as 9985-1000275, but without transparent lungs.

22x18x37 cm; 0.43 kg

[E/D/S/F/P/I/J](#) [www](#).

9985-1000274



9985-1000274

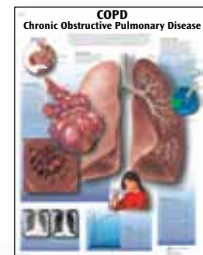

9985-4006678 *
9985-1001522 **

9985-4006668 *
9985-1001502 **

You will find our large selection of Charts starting on page 108.



9985-1000275

NEW

Lung / Heart

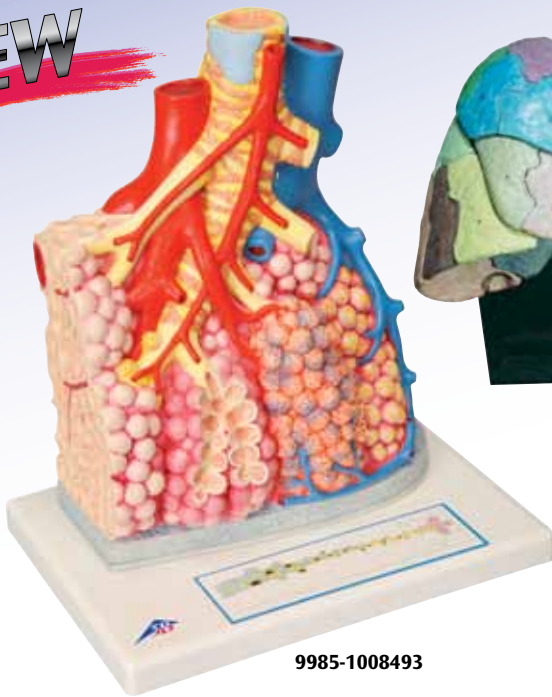

9985-1008493

Pulmonary Lobes

The model shows an external pulmonary lobe with a magnification of 130x. The following are represented:

- Segmental bronchus and its terminal branches (bronchioles)
- Alveolus opened on the right side
- Pulmonary vessels and their capillary networks
- Branch of a bronchial artery
- Pulmonary pleura
- Connective tissue septum on the left side
- Single opened alveolus with surrounding capillary network with a magnification of approx. 1000x on the rear side

A graphic representation on the stand of the model shows the structure of the air routes in the lungs up to the alveolus. 26x33x19 cm; 1.4 kg

L/D/E/S/F/P/J/C/R

9985-1008493



9985-1005861

Segmented Lung Reproduction

Cast from actual human lungs with representation of bronchial tree, bronchioles and alveoli. 18 coded segments held together elastically to allow easy viewing of the internal structures. Supplied on stand. 30x25x26 cm; 1.5 kg

E

9985-1005861



9985-1000270

Lung Model with Larynx, 7-part

This first class model contains the following removable parts:

- 2-part larynx
- Trachea with bronchial tree
- 2-part heart
- Subclavian artery and vein
- Vena cava
- Aorta
- Pulmonary artery
- Oesophagus
- 2-part lung (front halves removable)
- Diaphragm

On baseboard. 31x41x12 cm; 2.2 kg

L/D/E/F

9985-1000270



9985-1001243

Lung Model with Larynx, 5-part

Showing the following features:

- Larynx
- Trachea with bronchial tree
- 2-part heart (removable)
- Vena cava
- Aorta
- Pulmonary artery
- Oesophagus
- 2-part lung (front halves removable)

Delivered on baseboard.

12x28x37 cm; 1.25 kg

L/D/E/F/S

9985-1001243

BESTSELLER



9985-1000264

Classic Heart, 2-part

Highly detailed 2-part heart at a price you will love. The front heart wall is detachable to reveal the chambers and valves inside. Just slightly smaller than life size with exquisite detail throughout. On stand.

19x12x12 cm; 0.3 kg

L/E/D/S/F/P/J www.

9985-1000264



9985-1000265

Classic Heart with Thymus, 3-part

Same features as 9985-1000264, also including thymus.

20x12x12 cm; 0.3 kg

L/E/D/S/F/P/J www.

9985-1000265



9985-4006538 – 9985-1001188 +



9985-4006675 * 9985-1001516 **

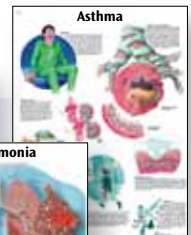

9985-4006677 * 9985-1001520 **



9985-4006676 * 9985-1001518 **

You will find our large selection of Charts starting on page 108.

Anatomy

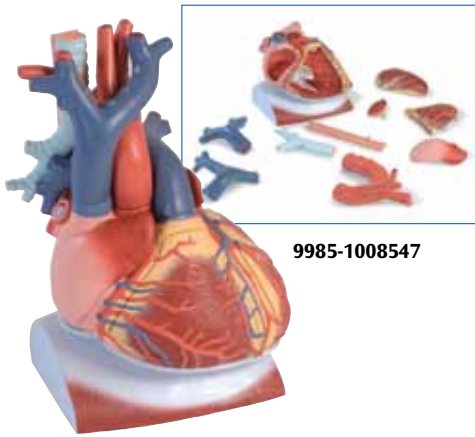

9985-1008547

Heart on Diaphragm, 3 times life-size, 10-part

This detailed heart depicts the structures of the diaphragm (= base). The following parts can be removed:

- Oesophagus
- Trachea
- Superior vena cava
- Aorta
- Pulmonary artery stem
- Both atrium walls
- Both ventricle walls

Supplied with a multilingual product manual.
41x33x28 cm; 3.6 kg
 L/E/D/S/F/P/I/J www.

9985-1008547

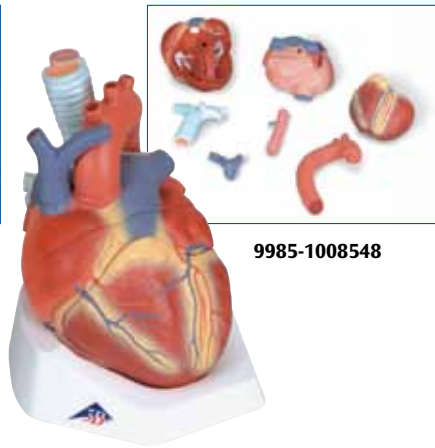

9985-1008548

Heart, 7-part

This model shows the anatomy of the human heart and is horizontally sectioned at the level of the valve plane. The following parts can be removed:

- Oesophagus
- Trachea
- Superior vena cava
- Aorta
- Front heart wall
- Upper half of the heart

On base. 20x15x17 cm; 1.1 kg
 L/D/E/F/S

9985-1008548



9985-1010006

Heart Model

The 5-part heart model is a didactically prepared original reproduction of a real human specimen. This model and an additional detailed representation of the cardiac valves during systole are presented on a stand.

- The parts of the model are fixed together with magnetic connections
- They can be taken apart very easily
- A true to original representation of all anatomical structures (e.g. papillary muscles and cardiac valves) in the atria and ventricles
- Detailed representation of the heart during systole: View of the base of heart with removed atria

25x21x13 cm; 1.52 kg
 L/E/D/S/F/P/I/J/C/R

9985-1010006



9985-1000266

Classic Heart with Conducting System, 2-part

Same features as 9985-1000264, however, this transparent model also displays the complete conducting system, which is represented in colour. Delivered on removable stand.

19x12x12 cm; 0.2 kg

9985-1000266

Heart Model

The 5-part heart model is a didactically prepared original reproduction of a real human specimen.

- The parts of the model are fixed together with magnetic connections
- They can be taken apart very easily
- A true to original representation of all anatomical structures (e.g. papillary muscles and cardiac valves) in the atria and ventricles.
- Colour scheme and disassembly of the heart model in a didactical manner. The chambers of the heart and vessels (including coronary vessels) in which oxygen rich blood is transported have been displayed in red. Heart chambers and vessels which contain blood low in oxygen have been reproduced in blue.

13x19 cm; 0.6 kg
 L/E/D/S/F/P/I/J/C/R

9985-1010007

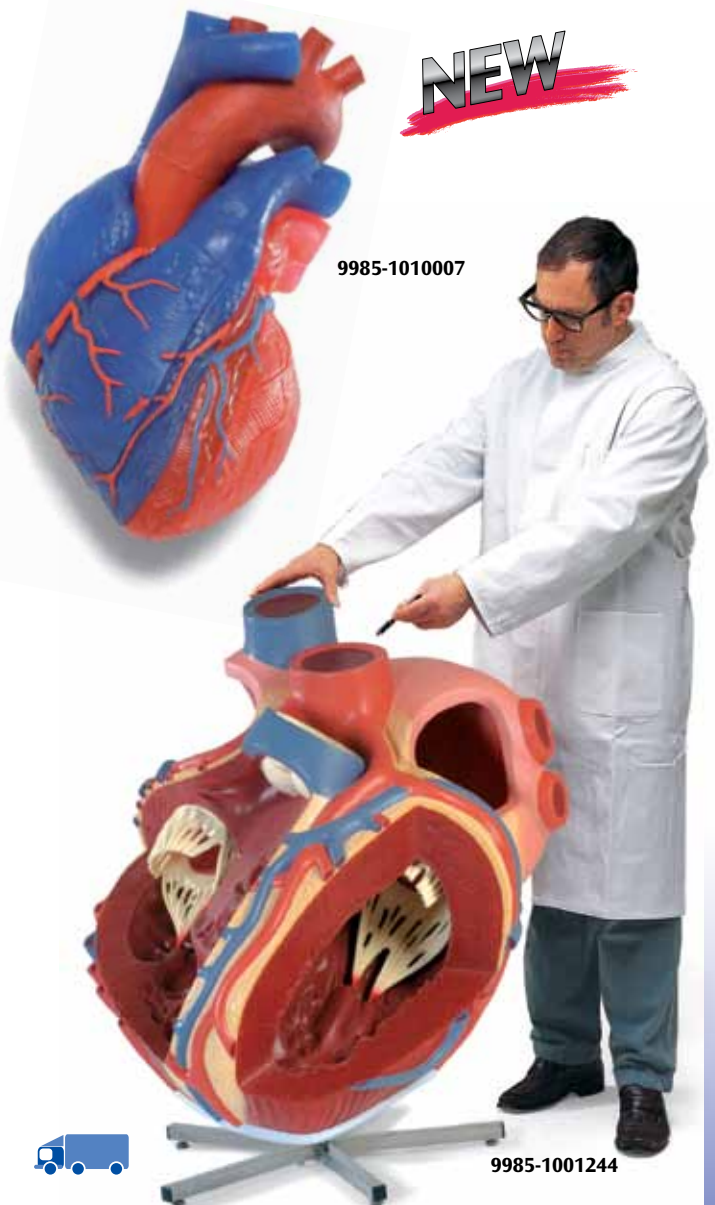

9985-1010007

Giant Heart, 8 times life size

See every detail of the heart with this giant 8 times life size model. Painstakingly constructed by hand, this heart will be the centre of attention at any exhibition and it is especially suitable for lecture halls. The atria and ventricles are open to give a view of the interior, and show the accurately modelled bicuspid and major vessels adjacent to the heart coronary heart vessels, are also accurately. On stand.

100x90x70 cm; 35.0 kg
 L/E/D/S/F/P/I/J www.

9985-1001244



9985-1001244

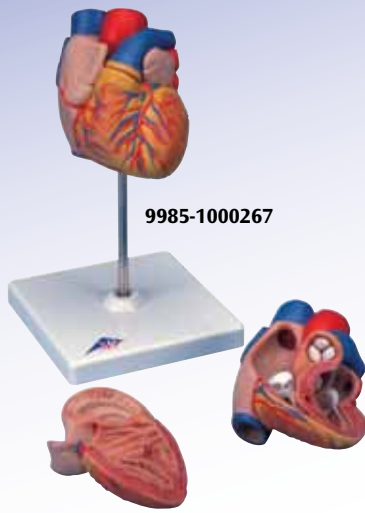

9985-1000267



9985-1000268

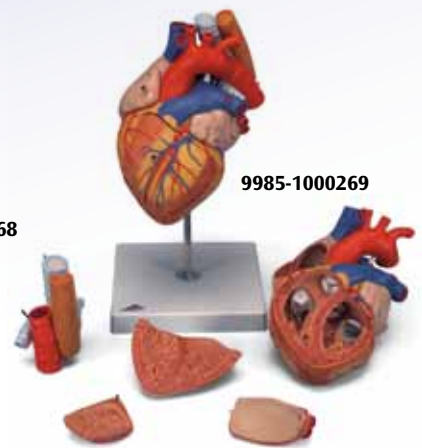

9985-1000269

Heart Model, 2-part

This model shows the anatomy of the human heart with ventricles, atriums, valves, veins, and the aorta in great detail. The front heart wall is removable to view the chambers and internal structures. Delivered on removable stand.

22x12x12 cm; 0.35 kg

 L/E/D/S/F/P/J [www.](http://www.3BScientific.com)

9985-1000267

Heart, 2-times life size, 4-part

This 2-times life size heart model allows easy identification of all structures and is a perfect aid for lessons in large classrooms or lecture halls. The atrium walls and the front heart wall are removable to reveal the most professionally detailed and realistic heart available. Hand painted in Life like colours to depict dozens of items of anatomical interest. Delivered on removable stand.

32x18x18 cm; 1.3 kg

L/D/E/F

9985-1000268

Heart with Oesophagus and Trachea, 2 times life size, 5-part

Same features as 9985-1000268.

Additionally depicts the upper section of the oesophagus, the upper bronchi and the ascending aorta.

The front heart wall and the atrium walls can be removed. Delivered on removable stand.

32x18x18 cm

L/D/E/F

9985-1000269



9985-1000263

Heart with Bypass, 2 times life size, 4-part

This 2-times life size heart is a great aid to teaching, even in large lecture halls or classrooms. The front heart wall can be removed to view the inner chambers of the human heart. In addition to the anatomy of the heart, this model shows a venal bypass to the ramus posterolateralis of the right coronary artery, to the ramus interventricularis ant. of the left coronary artery with branching to the ramus diagonalis as well as a bypass to the ramus circumflexus of the left coronary artery. On removable stand.

32x18x18 cm; 1.1 kg

L/D/E/F

9985-1000263



9985-1000262

Classic Heart with Bypass, 2-part

Same features as 9985-1000264, additionally including venal bypasses to the right coronary artery, to the ramus inter-ventricularis anterior, and also to the ramus circumflexus of the left coronary artery. This model is a great aid for explaining the treatment of coronary heart disease.

On removable stand.

19x12x12 cm; 0.35 kg

 L/E/D/S/F/P/J [www.](http://www.3BScientific.com)

9985-1000262

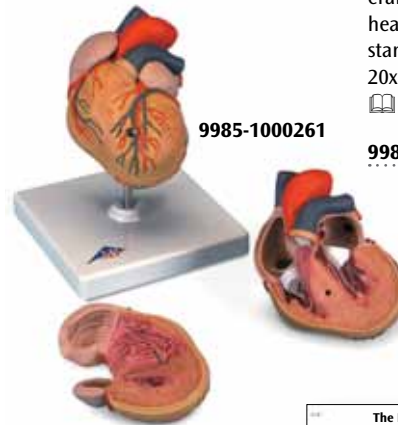

9985-1000261

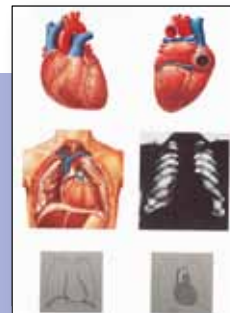
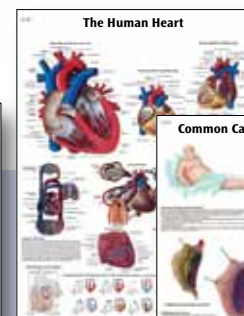
9985-4006552 –
9985-1001214 +9985-4006679 *
9985-1001524 **9985-4006680 *
9985-1001526 **

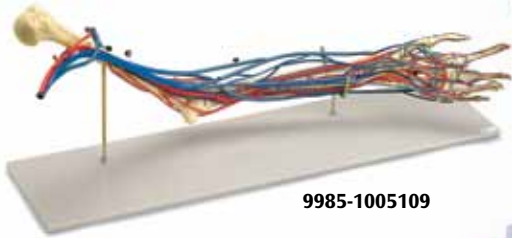

9985-1005109

Vascular Arm

Life size model of the left arm and hand in a semi-flexed position with the brachial, radial and ulnar arteries and accompanying veins with their radicals in situ. The complete circulatory system of the hand is shown on both palmar and dorsal surfaces. Comparative sizes of the various blood vessels are clearly indicated and facilitate the study of the blood circulation in the arm. Mounted on stand.

66x18x28 cm; 2.0 kg

E

9985-1005109



9985-1000277

Hypertension Model, 7-part

This model shows the harmful effects of hypertension on the most susceptible organs. It consists of scaled down depictions of: Brain, Eye, 2-part heart, 2-part kidney, an enlarged artery.

34.5x11.5x11.5 cm; 0.9 kg

E www.

9985-1000277



9985-1000278

Arteriosclerosis Model, with Cross Section of Artery, 2-part

With the help of this model doctors can explain changes in the blood vessels due to arteriosclerosis. A horizontally dissected artery fork is depicted with arteriosclerotic changes in four different stages, from slightly sedimented to a completely clogged vessel. On stand.

15 cm; 0.2 kg

9985-1000278

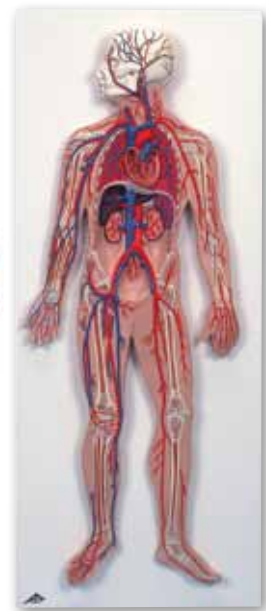

9985-1000276

Circulatory System

This 1/2 life size relief model shows:

- The arterial / venous system
- Heart
- Lung
- Liver
- Spleen
- Kidneys
- Partial skeleton

On baseboard.

80x30x6 cm; 3.6 kg

L/E/D/S/F/P/I/J www.

9985-1000276

Functional Heart and Circulatory System

This amazing working model will bring your lecture to life! A complete schematic model of the human circulatory system with "blood" (coloured water) that flows through transparent veins, arteries, capillaries and heart chambers. This model's special design portrays venous blood, a deep reddish purple and arterial blood, a bright red to give visual reinforcement to the oxygenation and deoxygenation of haemoglobin as it travels the body's vascular network. Mounted on a baseboard with support legs and supplied with teacher's guide, red dye and syringe for refilling the system.

36x16x38 cm; 1.5 kg

E

9985-1005045

3B MICROanatomy™ Artery and Vein

The model shows a medium sized muscular artery with two adjacent veins from the antebrachial area with adjoining fat tissue and muscle enlarged 14 times. The model illustrates the reciprocal anatomical relationship of artery and vein and the basic functional techniques of the venous valves ("valve function" and "muscle pump"). The left vein and the middle artery are fenestrated in the upper anterior segment, revealing the various layers of the wall structure in a cross and longitudinal section and in top view. The right vein is opened throughout in the anterior segment, revealing the orifice of a feeder vein and two venous valves, i.e. "flap valves" formed by a duplication of the tunica intima. On the rear of the model, the relief of two veins is shown to illustrate the functional aspect of the venous valves.

Supplied on base.

26x19x18.5 cm; 0.9 kg

L/D/E/S/F/P/I/J

9985-1000279



9985-1000279

9985-1005045



9985-4006515 – 9985-1001151 +

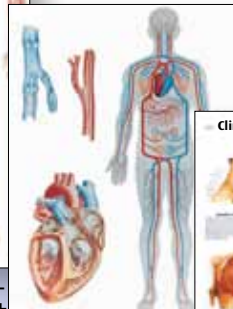

9985-4006525 – 9985-1001169 +



9985-4006682 * 9985-1001530 **

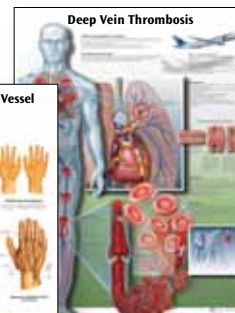

9985-4006685 * 9985-1001536 **



9985-4006684 * 9985-1001534 **

You will find our large selection of Charts starting on page 108.

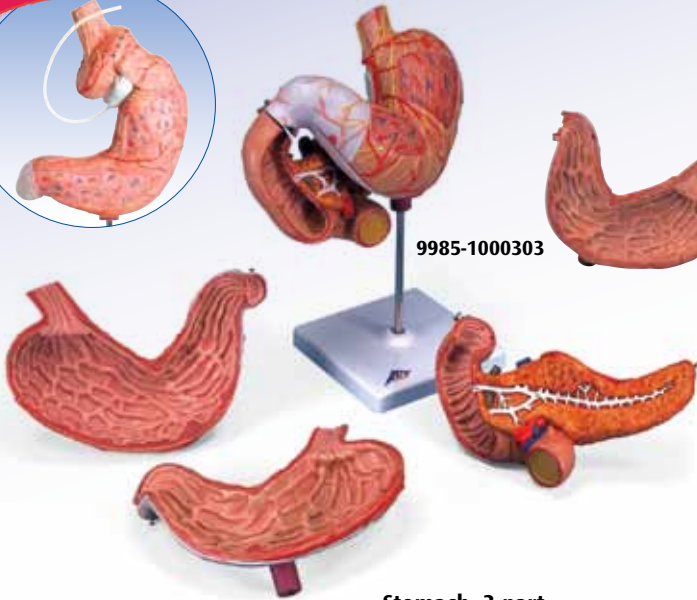

Stomach, 2-part
The model shows the different and individual layers of the stomach wall. The front half of the stomach is removable. Depicted are:

- The lower oesophagus
- Vessels
- Nerves

Supplied on stand.
25x22x12 cm; 0.6 kg
📖 L/D/E/F

Stomach, 3-part
Same features as 9985-1000302, additionally displaying the removable duodenum and pancreas. Supplied on stand.
25x22x12 cm; 0.8 kg
📖 L/D/E/F

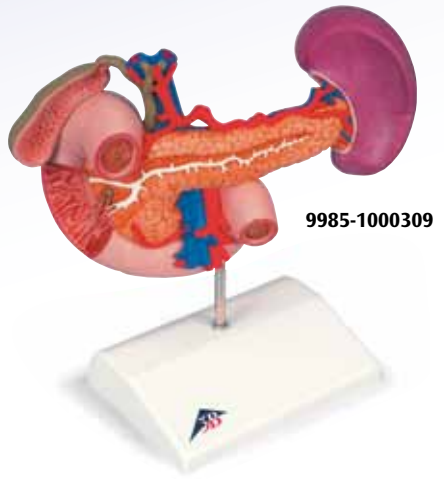

Rear Organs of the Upper Abdomen
The model shows the duodenum (partially opened), gall bladder and bile ducts (opened), the pancreas (revealing large ducts), the spleen and the surrounding vessels in natural size. On stand.
23x12x20 cm; 0.55 kg

9985-1000309



9985-1000303

Digestive System, 3-part
Life size model which accurately represents the entire digestive system in relief format.

Features:

- Nose
- Mouth cavity and Pharynx
- Oesophagus
- GI tract
- Liver with gall bladder
- Pancreas
- Spleen

The duodenum, caecum and rectum are opened. The transverse colon and front stomach wall are removable. Mounted on baseboard.
81x33x10 cm; 4.4 kg
📖 L/D/E/S/F/P/I/J [www.](http://www.3BScientific.com)

9985-1000307

Digestive System, 2-part
(not shown)
Same features as 9985-1000307, however without removable stomach half. Mounted on baseboard.
81x33x10 cm; 4.4 kg
📖 L/D/E/S/F/P/I/J [www.](http://www.3BScientific.com)

9985-1000306

3B MICROanatomy™ Digestive System
The model illustrates the structure of the fine tissues of four characteristic sections of the digestive system: oesophagus, stomach, small intestine, large intestine. The front of the model, from top to bottom, shows a magnified view in histological section of the individual sections of the digestive system and their fine tissue structures. On the back of the model, highly magnified views of didactically interesting areas of each of the digestive system sections shown on the front are emphasized.
29.5x26x18.5 cm; 1.5 kg
📖 L/E/D/S/F/P/I/J [www.](http://www.3BScientific.com)

9985-1000311



Kidneys with Rear Organs of the Upper Abdomen, 3-part
This model combines models 9985-1000308 and 9985-1000309. The upper abdominal organs are attached in their natural positions and may be separated from the kidneys. On stand.
24x18x29 cm; 1.4 kg

9985-1000310

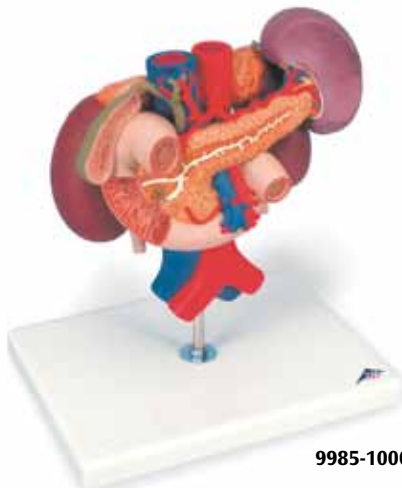

9985-1000310

9985-1000311





9985-1005532

Intestinal Villi, 100 times life size

This model consists of one entire villus, one longitudinally sectioned villus showing the arterioles and venules and one sectioned villus to show the lymphatic vessels. Also includes a longitudinal section of Lieberkühn's crypt. On base.

43x28x10 cm; 2.5 kg

E

9985-1005532



9985-1005533

Liver with Gall Bladder, 1.5 times full size

The complex vessels network in the opened liver, displayed in different colours:

- The hilus vessels
- The extra hepatic and intra hepatic bile ducts
- The gall bladder

Mounted on stand.

36x30.5x16 cm; 1.8 kg

9985-1005533



9985-1000313

Liver with Gall Bladder

- 4 lobes with gall bladder
- Extrahepatic ducts
- Hilus vessels

On removable stand.

18x18x12 cm; 0.5 kg

L/D/E/F

9985-1000313

Liver with Gall Bladder, Pancreas and Duodenum

This excellent relief model shows the liver with:

- Ducts
- Gall bladder
- Pancreas
- Duodenum
- Vessels
- Extra hepatic ducts with gall bladder
- Main pancreatic duct and their orifices

On baseboard.

4x20x18 cm; 0.8 kg

L/E/D/S/F/P/I/J [www.](http://www.3banatomy.com)

9985-1008550

3B MICROanatomy™ Liver

This 2-part model shows a highly magnified diagrammatic view of a section of the liver. The left part of the model shows a section of the liver that comprises several lobules. The right part of the model is a highly magnified view of the sectioned lobule on the left.

15x26x18.5 cm; 0.7 kg

L/E/D/S/F/P/I/J [www.](http://www.3banatomy.com)

9985-1000312

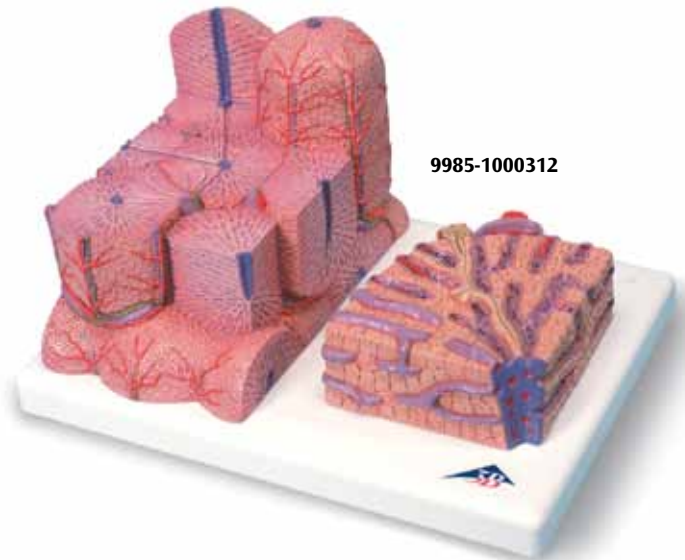

9985-1000312



9985-1008550

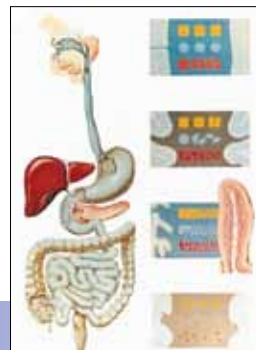

9985-4006542 –
9985-1001196 +

You will find our large selection of Charts starting on page 108.



9985-4006688 *
9985-1001542 **



9985-4006689 *
9985-1001544 **

Gallstone Model

This detailed model for patient education shows the anatomy of the biliary system and its surroundings in half natural size. Both acute inflammation (cholecystitis) and the tissue changes caused by chronic inflammation can be identified in the gallbladder wall. Gallstones can be found in the following typical locations:

- In the fundus area of the gallbladder
- In the area of the spiral valve
- In the area of the common bile duct
- In the papillary opening to the small intestine

Mounted on base.

14x10x19 cm; 0.2 kg

E/D/S/F/P/J [www.](#)

9985-1000314

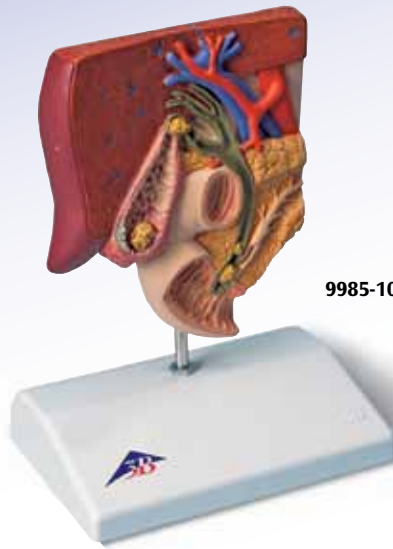

9985-1000314

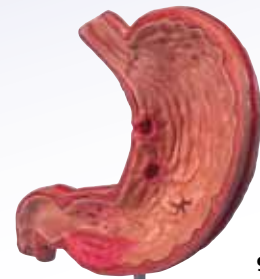

9985-1000304

Diseases of the Oesophagus

The following illnesses are represented:

- Reflux oesophagitis
- Ulcer
- Barrett's Ulcer
- Oesophageal carcinoma
- Oesophageal varices
- Hiatus hernia

Mounted on base.

14x10x19 cm; 0,194 kg

E/D/S/F/P/I/J [www.](#)

9985-1000305



9985-1000305

Stomach with Ulcers

The stomach section with oesophagus and duodenum attachment in half life size shows the following pathological changes:

- Erythematous gastritis
- Erosive gastritis
- Haemorrhagic gastritis
- Healing stage with scar formation
- Atrophic gastritis
- Hypertrophic gastritis
- Bleeding ulcer
- Perforated ulcer

An additional relief model of the enlarged stomach wall shows:

- Healthy mucous membrane
- Acute gastritis in the antral area
- Erosive gastritis with mucous membrane defects
- Bleeding ulcer (eroded muscularis mucosae)
- Perforated ulcer (all stomach layers eroded)

Mounted on a base.

14x10x17 cm; 0.3 kg

E/D/S/F/P/I/J [www.](#)

9985-1000304

Haemorrhoid Model

The model is a life size frontal section of the rectum with an additional smaller relief on a pedestal. In addition to the anatomical structures of the rectum (sphincter, mucous membrane, venous plexus), the model shows internal haemorrhoids during stage I and II as well as external haemorrhoids. The relief exhibit shows haemorrhoids during stage III and IV. Mounted on base.

14x10x14 cm; 0.2 kg

E/D/S/F/P/I/J [www.](#)

9985-1000315



9985-1000315

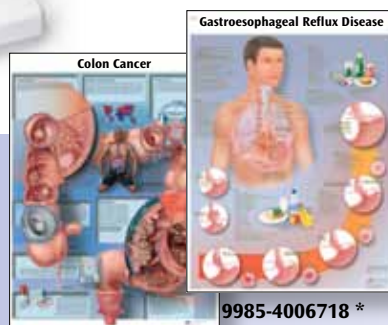

9985-4006718 *
9985-1001602 **



9985-4006690 *
9985-1001546 **

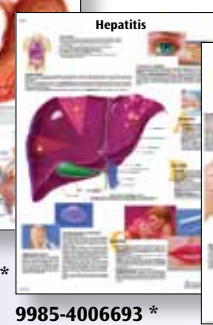

9985-4006693 *
9985-1001552 **



9985-4006691 *
9985-1001548 **

9985-4006692 *
9985-1001550 **

You will find our large selection of Charts starting on page 108.

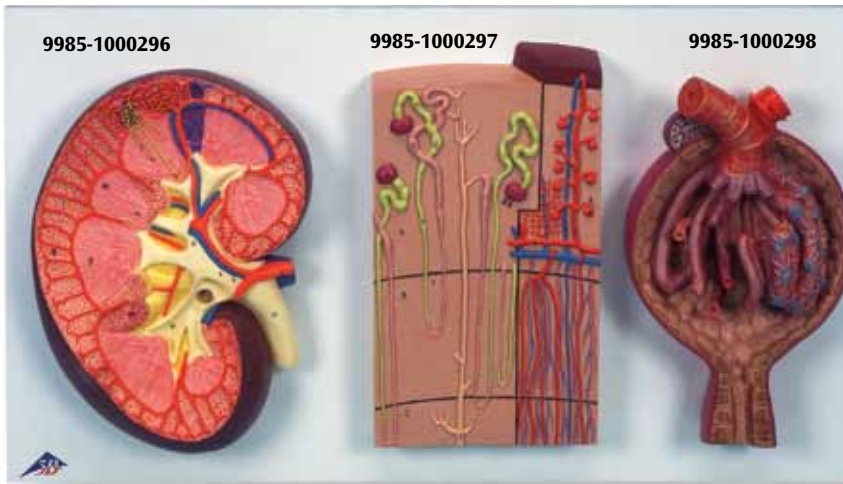

9985-1000296

9985-1000297

9985-1000298

9985-1000299

Kidney Section, Nephrons, Blood Vessels and Renal Corpuscle

A complete series of 3 models (9985-1000296, 9985-1000297, and 9985-1000298) for studying the kidney and its different structures in great detail. Delivered on baseboard.

29x52x9 cm; 2.8 kg

L/E/D/S/F/P/I/J [www.](http://www.3banatomy.com)

9985-1000299

Basic Kidney Section, 3 times full size

Longitudinal section of the right kidney. All important structures are shown.

8.5x19x26 cm; 0.9 kg

9985-1000295



9985-1000295



9985-1000300

Kidney with Adrenal Gland, 2-part

This model shows:

- Kidney with adrenal gland
- Renal and adrenal vessels
- Upper portion of ureter

The front half of the kidney is removable to enable demonstration of cortex medulla and vessels as well as renal pelvis. On stand.

20x12x12 cm; 0.9 kg

L/D/E/F/S/P/I/J/R/C [www.](http://www.3banatomy.com)

9985-1000300



9985-1000310

see page 76

Kidney Section, 3 times full size

Longitudinal section of the right kidney. On baseboard.

33x20x10 cm; 1.0 kg

L/E/D/S/F/P/I/J [www.](http://www.3banatomy.com)

9985-1000296

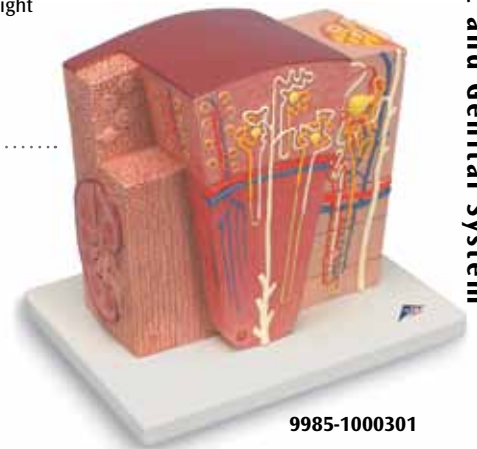

9985-1000301

3B MICROanatomy™ Kidney

This extremely detailed model shows the morphologic/functional units of the kidney greatly magnified. Six model zones illustrate the following fine tissue structures that serve the production of urine:

- Longitudinal section of a kidney
- Section of renal cortex and renal medulla
- Wedge shaped section of a kidney lobe with a diagrammatic depiction of three nephrons with Henle's loops of different lengths and diagrammatic representation of the vascular supply
- Diagrammatic illustration of a nephron with a short Henle's loop and didactic /diagrammatic illustration of the vascular supply
- Diagrammatic illustration of an opened renal corpuscle with nephron and light-microscopic transverse sections of the proximal, attenuated and distal segments of a renal tubule
- Diagrammatic /didactic illustration of an opened renal corpuscle Mounted on a base.

23.5x25.5x19 cm; 1.3 kg

L/E/D/S/F/P/I/J

9985-1000301



9985-1000308

Nephrons and Blood Vessels, 120 times full size

On baseboard.

26x19x5 cm; 0.7 kg

L/E/D/S/F/P/I/J [www.](http://www.3banatomy.com)

9985-1000297

Malpighian Corpuscle of Kidney, 700 times full size

On baseboard.

26x19x8 cm; 0.7 kg

L/E/D/S/F/P/I/J [www.](http://www.3banatomy.com)

9985-1000298



9985-1008551

Urinary System, male, 3/4 times full size

- Inferior vena cava
- Renal veins
- Aorta with its branches
- Iliacal vessels
- Ureter
- Urinary bladder
- Prostate
- Adrenal gland
- Rectum
- Musculature

The right kidney is opened.
10x18x26 cm; 1.0 kg

L/D/E/F/S

9985-1008551



9985-1000319

Prostate Model, 1/2 natural size

A cross section of the male genital organs shows a healthy prostate with bladder, urethra, testicle, symphysis and rectum. The narrowing of the urethra due to the change of the prostate is illustrated via the 4 cross sectional views. On base.

13.5x10x14 cm; 2.4 kg

L/E/D/S/F/P/I/J **www.**

9985-1000319



9985-1005535

Free Standing Urinary System, male

Represented are:

- Kidneys (right kidney in longitudinal section)
- Adrenal glands
- Abdominal aorta and its branches
- Inferior vena cava with branches
- Iliacal vessels
- Ureter
- Upper half of bladder and prostate (removable into pubic bone and symphysis as well as lower half of bladder and prostate).

Delivered on wooden base.

51x33x20 cm

E

9985-1005535



9985-1000283

Male Pelvis Section, 1/2 life size

This cross section of the male genital organs shows all structures in detail.

13.5x10x14 cm; 2.4 kg

L/D/E/F/S **www.**

9985-1000283

Dual Sex Urinary System, 6-part

- Structures of retroperitoneal cavity
- Large and small pelvis with bones and muscles
- Inferior vena cava
- Aorta with its branches including iliacal vessels
- Upper urinary tract
- Rectum
- Kidney with adrenal gland.

One front half of a kidney is removable. With easy to change male insert (bladder and prostate, front and rear half) and female insert (bladder, womb and ovaries, 2 lateral halves). Parts are numbered. On baseboard.

41x31x15 cm; 2.3 kg

L/E/D/S/F/P/I/J/R/C **www.**

9985-1000317



9985-1003642



9985-1003643



9985-1003644

Model of Kidney Vessels

This corrosion cast contains a real pig's kidney embedded in crystal clear plastic. The size and macro structure of pig's kidneys resemble those of human kidneys. Detailed spatial portrayal of vessel arborisation and progression is very well illustrated with different nuances of colour: red for the arterial flow area, blue for the venous blood vessels and yellow for the pelvicalyceal system/ureter. Each of the specimens is unique and therefore varied in shape. 14.5x8.5x4 cm; ca. 0.5 kg

Red Yellow Blue

Red for the arterial flow area, blue for the venous blood vessels and yellow for the pelvicalyceal system/ureter.

9985-1003642

Red-Yellow

Red for the arterial flow area and yellow for the pelvicalyceal system/ureter.

9985-1003643

Red

With red arterial flow areas.

9985-1003644

9985-1000317

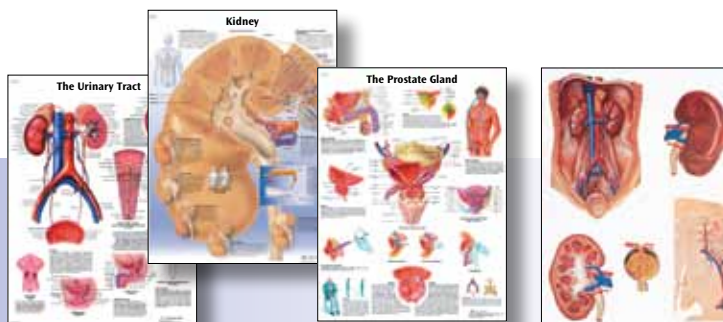
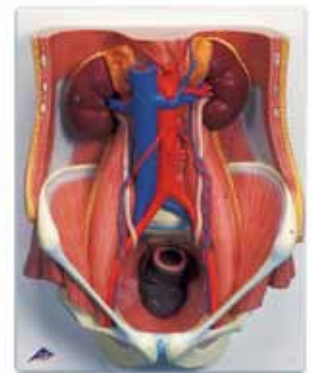

You will find our large selection of Charts starting on page 108

9985-4006698 *
9985-1001562 **

9985-4006699 *
9985-1001564 **

9985-4006700 *
9985-1001566 **

9985-4006523 -
9985-1001165 +



9985-1000281

Female Pelvis, 2-part
41x31x20 cm; 2.2 kg

9985-1000281



9985-1000282

Male Pelvis, 2-part
41x31x17 cm; 2.5 kg

9985-1000282



9985-1001254

Female Pelvis, 2-part
26x22x17 cm; 1.65 kg

9985-1001254

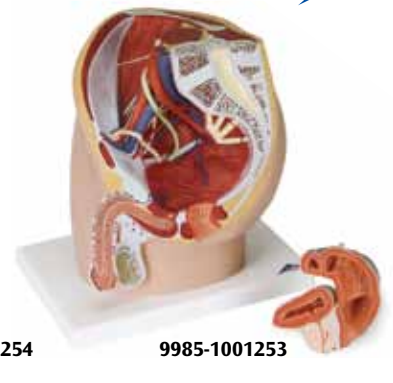

9985-1001253

Male Pelvis, 2-part
26x21x16 cm; 1.65 kg

9985-1001253

Median section. One half of genital organs with bladder, rectum is removable, one half is shown at the normal position in the pelvis. Supplied on baseboard offering the possibility to be mounted to the wall.

L/E/D/S/F/P/I/J [www.](http://www.3b.com)

Median section with removable half of genital organs with bladder and rectum. The abdominal and pelvic muscles are shown. Supplied on baseboard.

L/D/E/F/S



9985-1000316

Kidney Stone Model

The renal calices, the renal pelvis and the ureter are opened as well so that concretions or stones can be identified in the following typical positions:

- In the area of the renal pyramids
- In the area of origin of the upper calix group
- In the renal cortex
- In the connecting tubule of the lower calix group, causing congestion of the minor calices (partially closed, partially opened)
- In the ureter

4 original colour pictures on the base show various kidney stones. 14x10x16.5 cm; 0.18 kg

E/D/S/F/P/J [www.](http://www.3b.com)

9985-1000316

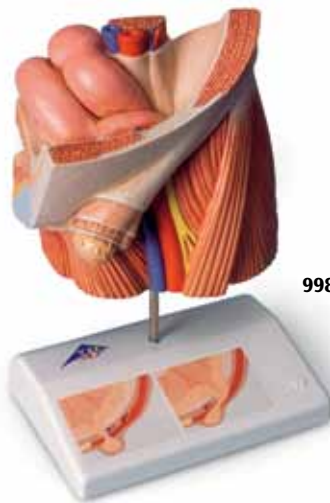

9985-1000284

Inguinal Hernia Model

This natural sized, accurate model shows the anatomical structures of a male groin with an indirect inguinal hernia, opened in layers. Two diagrammatic illustrations on the base allow for a comparison of direct and indirect hernia. Mounted on base.

14x10x18 cm; 0.28 kg

L/E/D/S/F/P/I/J [www.](http://www.3b.com)

9985-1000284



9985-1000335

Female Pelvis Skeleton with Genital Organs, 3-part

It consists of female pelvis with a movable symphysis, hip bone, sacrum, coccyx, 2 lumbar vertebrae and a female genital insert with rectum. Womb and bladder can be removed. Supplied on base. 33x26x18 cm; 2 kg

9985-1000335



9985-1000287

see page 38



9985-1000288

see page 38



9985-4006701 *
9985-1001568 **



9985-4006702 *
9985-1001570 **

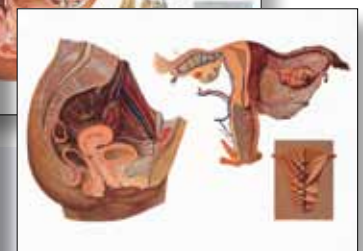

9985-4006528 -
9985-1001175 +

starting from page 108

NEW



9985-1001257

Embryonic Development in 12 stages

The model represents the development of the human germ cells from fertilisation until the end of the 2nd month of pregnancy in 12 stages. Each stage can be removed from the common stand as an individual part and can be removed used for teaching and tests for the embryological specialist field.

- Ovum at time of fertilisation (conception) with male gamete (sperm)
- Zygote at 2-cell stage, approx. 30 hours after fertilisation
- Zygote at 4-cell stage, after around 40-50 hours
- Zygote at 8-cell stage, after around 55 hours
- Morula
- Blastocyst after around 4, 5, and 8-9 days
- Germ cells at approx. 11th day and approx. 20th day
- Embryo at around the end of the 1st and 2nd month of pregnancy

65x6x34.5 cm; 1.55 kg

L/E/D/S/F/P/I/J/R/C

9985-1001257



9985-1001256

Embryonic Development, 12 stages

- Ovule shortly after fertilization
- Two cell stage
- Four cell stage
- Seven cell stage
- Morula stage
- Blastocyst with trophoblast and embryoblast
- Blastocyst with early formation of embryo process
- Blastocyst with start of implantation
- Embryo (approx. 12th day)
- Embryo (approx. 20th day)
- Embryo (approx. 28th day)
- Embryo (approx. 2nd month)

The first 8 models are enlarged approx. 4,000 times, the other 4 models are enlarged approx. 4-5 times. The first 8 stages can be removed from the baseboard for closer study. Delivered in storage carton.

12x59x41 cm; 3.35 kg

L/D/E/F/S

9985-1001256



9985-1000332

3B Scientific® Pregnancy Series

Our most popular series includes 8 models to show all the stages of development. 12x12x19 cm; 3.2 kg

L/E/D/S/F/P/I/J/R/C www.

9985-1000321

Embryo, 25 times life size

Showing embryo approx. 4 weeks old. 12x12x23 cm; 0.3 kg

L/E/D/S/F/P/I/J/R/C www.

9985-1000332

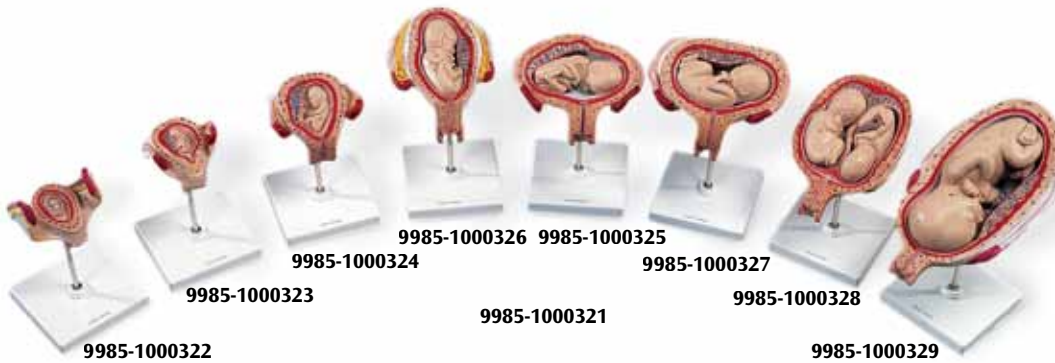

1st Month Embryo

0.2 kg

9985-1000322

3rd Month Embryo

0.3 kg

9985-1000324

5th Month Foetus, transverse lie

0.4 kg

9985-1000327

2nd Month Embryo

0.3 kg

9985-1000323

4th Month Foetus, transverse lie

0.4 kg

9985-1000325

5th Month Twin Foetuses, normal position

0.6 kg

9985-1000328

5th Month Foetus, breech position

0.4 kg

9985-1000326

7th Month Foetus

15x32x27 cm; 0.6 kg

9985-1000329

Deluxe 3B Scientific® Pregnancy Series, 9 Models

All models from our 9985-1000321 plus the Embryo 9985-1000332.

12x12x19 cm – 15x32x27 cm

L/E/D/S/F/P/I/J/R/C www.

9985-1000330



9985-1000333

Pregnancy Pelvis, 3-part

Representation of a median section through the female pelvis during the 40th week of pregnancy with a removable foetus. A model to study the normal position of child before birth. An uterus with embryo in 3rd month of pregnancy is mounted on base for added detail.

38x25x40 cm; 3.8 kg

L/D/E/F

9985-1000333

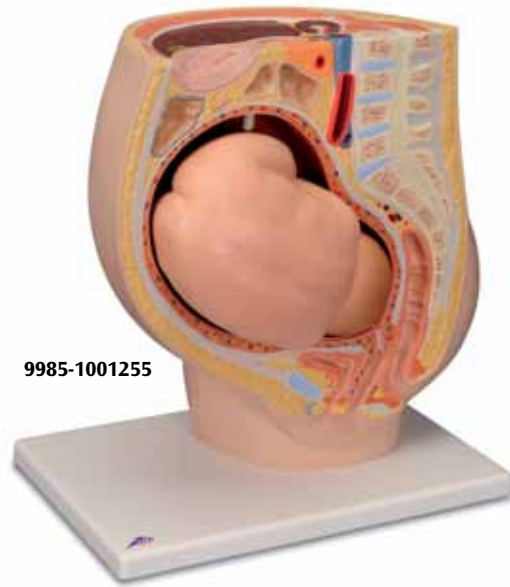

9985-1001255

Pregnancy Pelvis, 2-part

A median section through female pelvis during the 40th week of pregnancy with a removable foetus to study normal position of child before birth. Delivered on base.

44x42x37 cm; 4.4 kg

L/D/E/F/S

9985-1001255



9985-1003645

Placenta

This corrosion cast specimen of a human placenta is embedded in crystal clear plastic. Detailed spatial portrayal of vessel arborization and progression as well as the placental villi is achieved by injecting different coloured plastics into the placental vessels: red in the placental arteries and blue in the placental veins. The specimens vary in shape as each is unique.

21x17x4cm; approx 0.5 kg

9985-1003645



9985-1000331

3B Scientific® Pregnancy Series, 5 Models

The series consists of 9985-1000322, 9985-1000323, 9985-1000324, 9985-1000326 and 9985-1000329 with embryo or foetus to show the most important stages of development of. All models are mounted together on a base.

13x41x31 cm; 2.1 kg

L/D/E/F/P/S/J www.

9985-1000331



9985-1000320

Stages of Fertilisation and Development of the Embryo, 2 times magnified

The model illustrates schematically how the ovum matures, how ovulation and fertilisation occur and how the fertilised ovum develops to the stage where it embeds itself in the uterine wall to begin the growth into an embryo. The various stages are shown in larger-than-life model form in ovary, fallopian tube. An even more enlarged illustration of each is also printed on the base. Supplied on a base.

35x21x20 cm, 1.2 kg

L/D/E/S/P/I/J www.

9985-1000320

You will find our large selection of Charts starting on page 108



9985-4006703 *
9985-1001572 **

9985-4006562 –
9985-1001226 +



9985-1001258

Birthing Station Simulator – Cervical Examination

The Simulator is designed to facilitate the teaching, demonstration, and practice of cervical examination prior to birth. The complete simulator set consists of six separate pelvic blocks. The external appearance of all six blocks is identical with the variations being in the internal structure. Internal texture, tissue density, and correct anatomical size are all carefully represented to provide the most realistic condition possible. The simulators depict six different cervical conditions prior to birth. Each pelvic block is clearly identified on the bottom to indicate which condition exists internally. The different conditions depicted are:

- Stage 1: no dilatation, no effacement
- Stage 2: 2 cm dilatation, 50% effacement
- Stage 3: 2 cm dilatation, full effacement
- Stage 4: 5 cm dilatation, full effacement
- Stage 5: 7 cm dilatation, full effacement
- Stage 6: 9 cm dilatation, full effacement

Delivered with hard wall case.
34.5x18x52 cm; 8.0 kg

E

9985-1005599

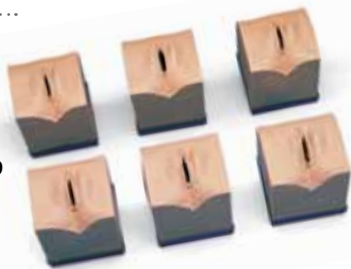

9985-1005599

Foetal Monitoring and Labour Progress Model Set

This model set provides realistic simulation of vaginal examinations, labour progress, and insertion of the intrauterine pressure catheter. An excellent tool for teaching nursing, medical, or midwifery students.

The lifelike, 3-D model includes:

- foetal head
 - foetal buttocks for breech presentation
 - four interchangeable cervical dilatation models (cervix 1: closed cervix; cervix 2: approx. 2cm; cervix 3: approx. 5cm; cervix 4: approx. 8-9cm).
- Comes with lubricant, teaching suggestions, and carrying case.

14x13x21 cm; 4.8 kg

E

9985-1005579



9985-1005579

Birthing Process, 5 stages

5 stages, mounted individually on bases:

- Foetus in womb, cervix closed.
- Foetus in womb, cervix open.
- Foetus in womb, start of head passage
- Foetus in womb and pelvis, finish of head passage
- Placenta in the womb

17x28x46 cm; 8.6 kg

9985-1001258



9985-1001259

Childbirth Simulator

A perfect model to teach and practice diagnostic and therapeutic manipulation before and during the birth. A female pelvis with covered belly cavity, removable vulva and a foetus. Supplied on baseboard.

30x55x55 cm; 5.5 kg

E/D/S/F/I

9985-1001260

Labour Stages Model

Same as 9985-1001258, but reduced in size to 50 %. Supplied on baseboard. 40x31x13 cm; 1,4 kg

9985-1001259



9985-1001260



9985-1005589

Birthing Station Simulator

This birthing simulator is especially designed to demonstrate and practice the palpation of the birth canal. It shows the relationship between foetal head and ischial spines of pelvic bone during birth. A simulated foetal head can be locked in three different stations to demonstrate its position above (-2cm), between (0cm) and below (+3cm) the ischial spines. Supplied with storage case.

58.5x46x33 cm; 10.0 kg

E

9985-1005589



9985-1005103

Childbirth Simulator with 5 Different Cervices, 7-part

Replica of the vagina with its surrounding structures which can manually palpated. With 5 different cervices, allowing the student to feel the changes during birth, and a doll with umbilical cord and placenta for learning and practicing obstetrics.

28x21.5x22.5 cm; 2.2 kg

E

9985-1005103

Childbirth Demonstration Pelvis

This model demonstrates the progress of the foetal head through the pelvis during birth. The simulator consists of a female pelvic skeleton with a movable symphysis, hip bone, sacrum, coccyx and 2 lumbar vertebrae articulated to accommodate passage of a foetal skull mounted on an omni positioning flexible gooseneck support. Delivered on baseboard.

33x26x18 cm; 1.8 kg

9985-1000334

Foetus Model

Simulating an average full term foetus, made of soft and durable cloth. The body is flexible to show all presentations and positions.

41x23x12 cm; 0.4 kg

E

9985-1005571



9985-1005571 / 9985-1005573

Options and Replacements for 9985-1005571

Placenta and Umbilical Cord

The amniotic membrane allows you to show the foetal model inside the sac. The snap-on umbilical cord clearly shows the vein and arteries and a convenient drawstring closes the sac. Both amniotic and chorionic membranes are detailed accurately in two colours.

9985-1005573

Pelvic Model

Made of flexible cloth, this pelvic model shows how the different pelvic shapes affect pregnancy, labour and birth.

9985-1005575



9985-1000334

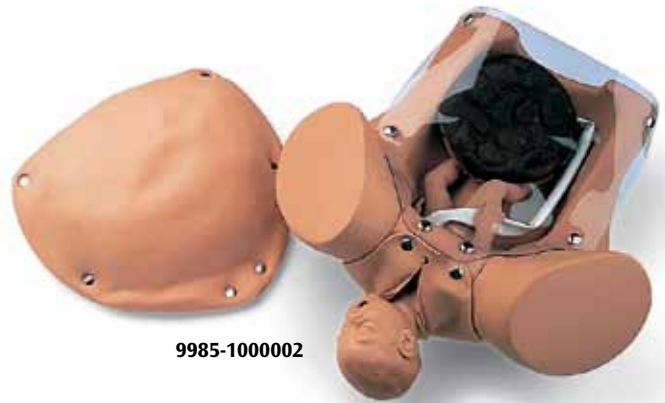

9985-1000002

Options and Replacements for 9985-1000002

Placenta

9985-1005714

Umbilical Cord

9985-1005715

Simulated Amniotic Fluid

9985-1005716

6 Umbilical Cord Clamps

9985-1005717

Full Term Newborn for Forceps Delivery

9985-1005718

Vulva

9985-1005719

Clear Abdominal Overlay

9985-1005720

Pregnant Belly Overlay

9985-1005721

Blood Powder (4.5 l)

9985-1005722

Childbirth Simulator

This lifelike simulator gives your trainees practice in normal vaginal delivery as well as procedures for breech and vertex presentation. The simulator contains two interchangeable abdominal overlays – one containing an additional foetus in a simulated amniotic fluid sac for practicing Leopold's manoeuvre, the other being transparent to allow a view of the foetal position. Also features:

- Anatomically correct female pelvis with representation of internal landmarks such as spinal column, angled birth canal, ileum, ischium, sacrum, sacro spinous ligaments and greater sciatic notch
- Full term foetus with fontanelles and cranial sutures
- Placenta with six disposable umbilical cords and clamps
- Easily replaceable spare vulva
- Simulated blood powder
- Soft carrying bag

53.5x33x43 cm; 9.0 kg

E

9985-1000002



Practice Makes Perfect!

The birth simulator SIMone™ is a model of a female abdomen with a vulva and the ischial spines as landmarks. Inside the model there is a foetal head with a sagittal suture and fontanelles. The monitor above the model displays an exact image of the position and rotation of the foetal head within the maternal pelvis. Furthermore, the CTG and partogram, as well as documentation (history, findings) and interventions, are displayed. Objective determination of the position of the foetal head in relation to the maternal pelvis is also now possible. SIMone™ represents the complete clinical course including anamnesis, diagnosis and intervention. A variety of delivery scenarios are presented and the cardiocotogram and partogram support the assessment of the course of the delivery. The repositioning of the mother, the administration of medication and amniotomy are all interventions that may be used in order to achieve the necessary progress during the delivery. In order for the physicians that are carrying out the procedures to determine their level of proficiency, all the measures taken during the 'delivery' can be reviewed afterwards. The internationality of mothers-to-be and the number of different scenarios are a true reflection of the realities of the delivery room.

The High Level of Realism in Training with SIMone™ is Unique

- because the instruments are used together with application of the natural force to guide the baby along the natural curve of the pelvic axis (Patented haptics)
- because the characteristic sounds due to the breathing and pain of the mother as well as the foetal heartbeat make the situation very lifelike

The Birth Simulator SIMone™ allows Training in

- correct use of instruments in assisted vaginal delivery
- defining the position of the foetal head in relation to the maternal pelvis
- management of birth complications by means of anamnesis, findings and interventions

Safety During Instrument Use

The simulator presents the haptics required in order to perform the instrument assisted delivery in a medically correct manner: presentation data, placement of the forceps and extraction, taking care of the head of the infant and the maternal soft tissue. The monitoring software provides information in interactive haptic response to the manipulation of the foetal head in the context of force-feedback. The speed and resistance shown during pulling correspond with a real situation.

Recognising the Right Moment

During the delivery scenario, the user of the simulator assesses the course of the delivery and considers all the necessary measures, such as the recognising the correct time for a forceps delivery. In this context questions concerning indications and conditions are always decisive: Are the forceps necessary? Are the forceps feasible?



Professional Endorsement

SIMone™ tested and evaluated by more than 50 doctors with experience in obstetrics. The majority of those questioned (83.0%) stated that the simulator was very highly or highly realistic. Almost all of the participating doctors (96.1%) would recommend other doctors to use SIMone™ for obstetric training to prepare for all sorts of complications effectively.*

* Wulf J, Lüdemann C, Lukutin W, Burgkart R: Expert assessment of a high-fidelity audio and force feedback birthing simulator: a questionnaire-based validation study.

Proceedings of the 14th Annual Meeting of the Society in Europe for Simulation Applied to Medicine; University of Herfordshire, Hatfield, UK, 19-21 June 2008



Using the delivery training simulator SIMone® will enable inexperienced staff (such as young physicians and midwives) to prepare for complications and obstetric emergencies in order to reduce these risks. The fact that more and more C-sections are performed today than ever before, reduces the experience of individuals and therefore underlines the need for such a simulator. Even experienced obstetricians can benefit from extra training managing the challenges of difficult birth scenarios, with the benefit of feedback relating to the haptic performance, e.g. during vacuum or forceps delivery. SIMone® is an excellent simulator to train both obstetricians and residents in operative delivery techniques. The feeling and confidence that the trainees have been in the situation with successful results will allow them to respond quickly and appropriately to the mother and foetus during labour. The numerous intervention and delivery scenarios keep the students and young physicians always able and ready to cope with particular problems that can occur during delivery. The process of learning through assessment and error correction promotes a powerful learning environment. Memory and retention are clearer with simulation.

(Roland Zimmermann MD, Professor and Chair University Hospital Zurich)





1 Day for Simulator Set-up, Operation and Training Session
(including travel expenses within the EU)

9985-10135

1 day of Workshop: Commissioning, Training on the SIMone™ Birthing Simulator and Disassembling
(travel costs included within the EU)

9985-10136

Spare Parts and Accessories

Replacement Foetal Head with Metal Rail

9985-1012764

Lubricant 200 ml

9985-1009867

Stylus Pen for Touch-screen

9985-1009487

Protective Cover

9985-1009488

SIMone™ Birth Simulator

Unique simulator with haptic, visual and acoustic interface as a training module for the use of instruments during an assisted vaginal delivery.

Includes:

- Simulator mechanics with maternal pelvis, foetal head etc.
- Software with 5 scenarios for model-based training of instrumental delivery and problem based training of birth management
- Future compliance by progressive upgrade with additional scenarios
- 1 Suction cup, Menox ø 60mm
- Hand vacuum pump 0-1.000 mbar
- 1 Obstetrical forceps:
 - N = Naegele 36cm, S = Simpson 30 cm,
 - T = Tarnier 38 cm, MT = McLean-Tucker 39 cm
- 2x 200 ml lubricant (9985-1009867)
- Latex free disposable gloves, size 8 (M) and 9 (L), 100 pieces
- 2 Spare genital inserts (9985-1008555)
- 19" Flat screen, computer unit and multi-range power supply unit (110-240 V, 50/60 Hz)
- Adapter for plug types B, D, E, F, G /BS1363, I, J, L and M (150 countries)
- Table with drawer for accessories
- Set-up and Operating Instructions
- 3 Year guarantee

Software is available in the languages DE, ES, FR, GB and US

D/E/F/S/I/P www.

9985-1000516





9985-1005814



9985-1005824



9985-1005790

Childbirth Simulator

This versatile simulator features the pelvic cavity with major anatomical landmarks and painted outline of bony pelvis. It allows intra uterine manipulation and various training possibilities for prenatal, intra partum, and postpartum skills as follows:

- Foetal palpation of fontanelle, backbone, knees, and elbows
- Vertex presentation
- Normal vaginal delivery
- Complete, frank and footling breech delivery
- C-section delivery
- Vertex and breech presentations in multiple delivery
- Demonstration of placenta previa: total, partial, and marginal
- Prolapse of umbilical cord
- Ritgen's manoeuvre
- 3 soft vulva inserts for episiotomy exercises
- Normal delivery of umbilical cord and placenta
- Suction of baby's nose and mouth

Supplied with 2 stomach covers (skin-tone /transparent), 1 male and 1 female foetus with placenta, 5 umbilical cords, 2 umbilical clamps, talcum powder and carrying bag.

53x33x43 cm; 8.0 kg

E

9985-1005790

Options and Replacements for 9985-1005790

Articulating Foetus

Representation of a 42 cm foetus with articulating head and neck, shoulders, elbows, hips and knees for more realistic practice of difficult delivery exercises such as Leopold's or Ritgen's manoeuvres.

Features include:

- Realistic mouth and nostrils for simulated suctioning
- Palpable fontanelle, spine, shoulders, buttocks, elbows, and knees

Supplied with carrying bag.

81x20x20 cm; 2.3 kg

E

9985-1005814

Palpation Module for Leopold's Manoeuvres

This module consists of a foetus, 2 cushions which may be inflated with air and an inflation device. Inflation of the lower cushion raises the foetus to desired position; inflation of the upper cushion creates a firm abdomen as in the ninth month of pregnancy. The foetus with palpable fontanelle, spine, shoulders, elbows, and knees may be placed in normal, breech, or transverse position and will be cradled between the 2 cushions.

33x30x18 cm; 1.8 kg

E

9985-1005823

Labour Delivery Module

The 6 labour stations represent conditions of the cervix and vagina prior to labour, during labour, and at birth in a primigravid woman.

Stations illustrated are:

- Station -5: Prior to onset of labour
- Station -4: Cervix partially effaced
- Station -3: Cervix fully effaced
- Station 0: Foetal head at plane of ischial spine
- Station +2: Cervix nearing full dilation
- Station +5: Crowning of foetal head

Delivered with carrying case.

52x34.3x16.5 cm; 0.5 kg

E

9985-1005824

Foetus for Vacuum Delivery (not shown)

Features smooth, soft skull with fontanelle for realistic vacuum delivery. With placenta and umbilical cord.

52x14x11.4 cm; 1.0 kg

E

9985-1005791



9985-1005823



NOELLE® Birthing Simulator

- Full size articulating full-body female
- Intubatable airway with chest rise
- IV arm for meds / fluids
- Removable stomach cover
- Practice Leopold Manoeuvres
- Multiple foetal heart sounds
- Automatic birthing system
- Measure head descent and cervical dilation
- Multiple placenta locations
- Replaceable dilating cervices
- Practice postpartum suturing on vulval inserts
- 1 articulating birthing baby with placenta
- 1 resuscitation baby with intubatable airway and umbilical catheter site
- New postpartum haemorrhage and palpation module

Supplied with:

- 2 umbilical cords
- 2 dilating cervices
- 2 umbilical clamps
- 2 vulval inserts
- 3 vulva for postpartum suturing
- Talcum powder and silicone lubricant
- NOELLE training guide
- NOELLE teaching guide with scenarios
- Carrying bag

E

9985-1012417

NOELLE® Birth Simulator with PEDI® Blue Neonate

- Full size articulating full-body female
- Intubatable airway with chest rise
- IV arm for meds / fluids
- Removable stomach cover
- Practice Leopold Manoeuvres
- Multiple foetal heart sounds
- Automatic birthing system
- Measure head descent and cervical dilation
- Multiple placenta locations
- Replaceable dilating cervices
- Practice postpartum suturing on vulval inserts
- 1 articulating birthing baby with placenta
- PEDI® Blue Neonatal Simulator with SmartSkin™
- New postpartum haemorrhage and palpation module

Supplied with:

- 2 umbilical cords
- 2 dilating cervices
- 2 umbilical clamps
- 2 vulval inserts
- 3 vulva for postpartum suturing
- Neonatal monitor
- International power supply 100-240 VAC
- Connecting cables
- Talcum powder and silicone lubricant
- NOELLE training guide
- NOELLE Teaching Tips with scenarios
- Carrying bags

E

9985-1012732



Episiotomy Suturing Simulator, Set of 3

This simulator provides a realistic way for students to learn surgical techniques without the constraint of time and concern for safety, which are factors with a live patient. In addition to being portable, the lifelike texture allows the learner to develop a “feel” for instrument handling, tension on suture and the advantages of one method of tying knots over another. The set includes midline, left mediolateral and right mediolateral episiotomies and is supplied in a storage case.

Needle holder, suture material and tweezers are not included in scope of delivery.

20x15x7 cm; 1.5 kg

E

9985-1005627

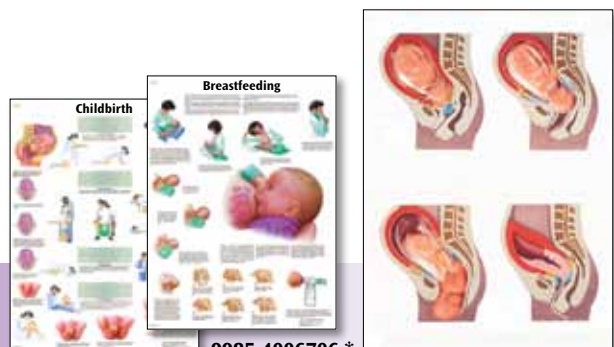

9985-4006704 *
9985-4006704 **

9985-4006706 *
9985-1001578 **

9985-4006547 –
9985-1001204 +

You will find our large selection of Charts starting on page 108.



9985-1000342

Wearable Breast Self Examination Model

Demonstrate realistic self examination with our natural casting of a female upper body with medium sized breasts. It can easily be worn, in order to better train and practice breast self examination.

- Made of 3B SKINlike™ high quality silicone
- Displays the skin in finest detail
- Very realistic to the touch and dermatologically tested
- Breast examination is possible in both upright or lying positions
- Benign and malignant tumours in different stages of development hone self examination skills
 - 2 benign tumours
 - 4 malignant tumours
 - 2 typical anomalies
- Includes "Female Breast" chart
- Supplied with talcum powder, harness, stand and aluminium carrying case

56x44x24 cm; 11.5 kg

E/D/S/F/P/J [www.](http://www.3bscientific.com)

9985-1000342

Options and Replacements for 9985-1005159

9985-1005160 3 Fluid Filled Cysts

9985-1005161 Outer Breast Skin

9985-1005162 Lumpy Axillary Gland



9985-1005159



9985-1005159

Clinical Breast Trainer

This trainer combines modularity and practicality for clinical skills in diagnosis and palpation.

- Five identifiable anatomical anomalies.
 - Fluid filled cyst for aspiration and palpation
 - 2 palpable lumps (approx. 1 cm and 1.5cm diameter) on the lateral side of the breast
 - Infection in armpit in axilla region
 - Lump in tissue above the clavicle
 - Modular design for simple replacement of skin, cyst, lump axillary gland
 - Skin detaches for replacing cysts
 - Realistic tactile feel
 - Easy to keep clean
- 22x25x14 cm; 2.0 kg

E

9985-1005159



Wearable Breast Self Examination Model

Same features as 9985-1000342, supplied without "Female Breast" chart and transport case.

51x37x15 cm; 6.3 kg

E/D/S/F/P/J [www.](http://www.3bscientific.com)



9985-1000343



9985-1000344

Breast Self Examination Model, Three Single Breasts on Base

Very realistic natural casting of three different female breasts in C and D cups, to train and practice breast examination.

- Made of new 3B SKINlike™ high quality silicone
- Displays the skin in finest detail
- Very realistic to the touch and dermatologically tested
- Benign and malignant tumours in different stages of development are featured in two breasts
- A healthy breast is supplied for comparison
- Supplied with base and talcum powder

52x24.5x9.5 cm; 2.3 kg

E/D/S/F/P/J [www.](http://www.3bscientific.com)

9985-1000344

NEW



9985-1008497

Female Breast and Chest Wall with Representation of Different Diseases

Milk giving right breast:

- Medially divided into 2 halves, held together with magnets
- Healthy milk-giving breast tissue on the cut surface of the external half
- Breast gland inflammation (mastitis) on the cut surface of the inner half

Non milk giving left breast:

- 2 saggital cuts, can be separated into 3 parts, held together with magnets
- Healthy anatomical structures on the sectional plane of the external half
- Skin on the external half is windowed to view the regional lymph nodes
- Cysts and fibroadenoma on the external sectional plane of the middle breast cut
- Pathological proliferation of the breast connective tissue (fibrocystic breast disease) on the inner sectional plane of the middle breast cut
- Malignant tumours on the sectional plane of the inner breast cut

9985-1008497



Gynaecology Simulator

This simulator represents a female adult lower body with removable soft outer skin as well as anatomically accurate fimbriae and ovaries. Various pelvic examinations including recognition of pathologies and placing of contraceptive devices can be trained. Features include:

- Vaginal speculum and bi-manual pelvic examination
- Uterine sounding
- Insertion and removal of contraceptive devices such as IUD, diaphragm, cervical cap, contraceptive sponge or female condom

The simulator is supplied with normal and abnormal cervixes and uteri which can be easily changed:

- 1 normal anteverted uterus with transparent top and round ligaments
- 1 normal uterus
- 6 uteri with external pathologies
- 2 normal cervixes with patent as for IUD insertion / removal
- 6 cervixes with pathologies

Supplied with talcum powder and carrying bag. Speculum is not included in scope of delivery.

51x46x25.5 cm; 8.5 kg

E

9985-1005789



9985-1005789

Gynaecology Simulator

This simulator represents a female adult lower body with relevant internal anatomical landmarks and anatomically accurate fimbriae and ovaries. Various pelvic examinations including laparoscopy, mini laparotomy as well as recognition of pathologies and placing of contraceptive devices can be trained. Features include:

- Vaginal speculum and bi-manual pelvic examination
- Uterine sounding
- Insertion and removal of contraceptive devices such as IUD, 75mm diaphragm, or female condom
- Laparoscopic visualisation and occlusion of fallopian tubes
- Mini laparotomy

The simulator is supplied with normal and abnormal cervixes as well as normal and pregnant uteri which can be easily changed:

- 1 anteverted and 1 retroverted parous uterus
- 2 pregnant uteri (ten week / twenty week)
- 5 normal cervixes with patent as for IUD insertion / removal
- 4 cervixes with pathologies

Supplied with 10 fallopian tubes, talcum powder and carrying bag.

The image shows an opened model to make the inner structures visible.

The model is supplied with a closed abdomen. Hook is not included in scope of delivery.

51x46x25.5 cm; 8.5 kg

E

9985-1005797

Options and Replacements for 9985-1005797

7 Uteri – Normal and with External Pathologies

E

9985-1005798

7 Uteri – Normal and with Internal Pathologies

For hysteroscopic viewing.

E

9985-1005799

Postpartum Uterus

48 hour postpartum uterus with duckbill cervix and fallopian tubes for IUD insertion, using long curved forceps. Speculum and bent forceps are not included in scope of delivery.

29.2x14x14 cm; 0.5 kg

9985-1005812

2 Early Pregnant Uteri

6-8 week and 10-12 week pregnancy uteri, both with 3 interchangeable cervixes.

9985-1005813

Detail 9985-1005797



9985-1005797

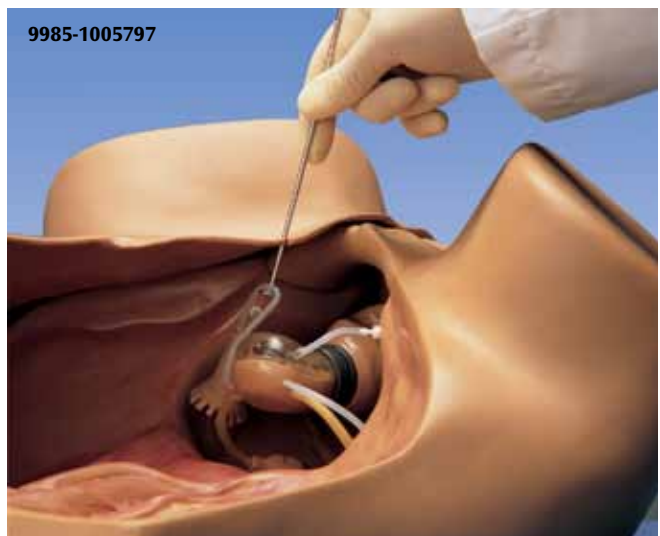



9985-1005723

Gynaecology Trainer

The life like female pelvis allows the development of diagnostic skills in gynaecologic procedures through anatomical instruction, abdominal palpation and speculum insertion. Constructed of soft, easily cleaned vinyl materials that approximate skin texture, the trainer provides detailed life like anatomical features and references. Included are the following interchangeable inserts:

- Normal cervix and uterus for IUD insertion and removal
- Normal parous cervix
- Cervix with endocervical polyp
- Cervix with ectropion characteristics
- Cervix with neoplasia (carcinoma)
- Pregnant 10 week uterus
- 2 adnexal masses

30.5x33x33 cm; 4.0 kg

E

9985-1005723

Family Planning Educator

Desktop simulator for training and demonstration of:

- Introduction and removal of a diaphragm, an IUD or sponge contraception devices
- Normal and abnormal uterine positions
- Bi-manual examination technique

Supplied with:

- One anteverted uterus with clear upper half to illustrate correct position of IUD
- One uterus to illustrate normal anteversion and retroversion
- Cervix with patent os attaches to uterus suspended within pelvic cavity
- Soft plastic stomach cover
- Carrying bag

E

9985-1005784



9985-1005784

Options and Replacements for 9985-1005784

Artificial Semen
(UV-fluorescent fluid)

9985-1005561



9985-1005826

Female Condom Model

This model represents an anteverted uterus in a simulated pelvic cavity with soft vulva and vagina and a soft plastic stomach cover. A perfect tool to demonstrate the use of a female condom, contraceptive sponge and cervical cap. Supplied with carrying bag.

17.8x24x14 cm

E

9985-1005826



9985-1000339

Training Model for a Female Condom

This model shows the labia and vagina up to the cervix in a simplified representation for didactic reasons, and is used for demonstrating and learning the insertion of a female condom. Supplied with one Femi-condom. White skin.

12 cm; 0.15 kg

9985-1000339

Dark Skin

9985-1000338

I.U.D Trainer

Hand-held trainer which is a suitable aid for understanding correct positioning of I.U.D. (Intrauterine Device) in the uterus. Made of durable plastic, the trainer features a transparent cover which allows easy visualization of insertion and placement of I.U.D. (I.U.D. not included).

6x40x45 cm

E

9985-1005766



9985-1005766



You will find our large selection of Charts starting on page 108.

9985-4006707 *

9985-1001580 **

I.U.D Trainer

This anatomically accurate model represents a section of the uterus, ovaries and fimbriae. The uterus is covered by a clear plastic window to allow easy sight of insertion and placement of I.U.D. (I.U.D. not included).

E

9985-1005825



9985-1005825

3B Scientific® Models of Cell Division

These three dimensional relief models are painted according to the usual colouring methods of microscopy, making the process of cell division easy to understand. The cell organelles are shown opened up in the lower part of the models. The models are equipped with magnets on the back so that for teaching purposes, they can be arranged easily on a magnetic board in the classroom. The model series is supplied in a storage system (40x60 cm) which can be fastened to the wall. A detailed description and handouts for your lessons are included.

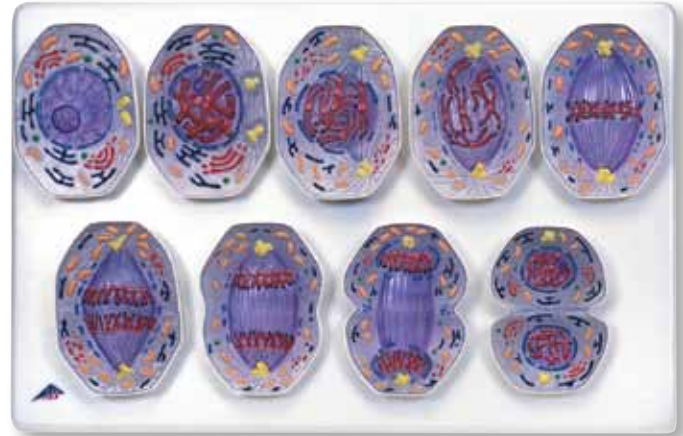

9985-1000521

Mitosis Model

Shows the 9 stages of mitosis on the basis of a typical mammal cell at an enlargement of approx. 10,000 times:

1. Interphase
2. Prophase
3. Early prometaphase
4. Later prometaphase
5. Metaphase
6. Early anaphase
7. Later anaphase
8. Telophase
9. Cytokinesis

Tip: As a useful addition and permanent eye catcher in the classroom we recommend the matching wall chart "Mitosis" (product number V2049M, V2049U).

60x40x6 cm; 1.5 kg
E/D/S/F/P/J www.

9985-1000521

Meiosis Model

Shows the 10 stages of meiosis on the basis of a typical mammal cell at an enlargement of approx. 10,000 times:

1. Interphase (stage of G1-phase)
2. Prophase I (leptotene)
3. Prophase I (zygotene and pachytene)
4. Prophase I (diplotene)
5. Prophase I (diakinesis)
6. Metaphase I
7. Anaphase I
8. Telophase I, cytokinesis I, interkinesis, prophase II and metaphase II
9. Anaphase II
10. Telophase II and cytokinesis II

Tip: As a useful addition and permanent eye catcher in the classroom we recommend the matching wall chart "Meiosis" (V2051M, V2051U).

60x40x6 cm; 1.7 kg
E/D/S/F/P/J www.

9985-1000522

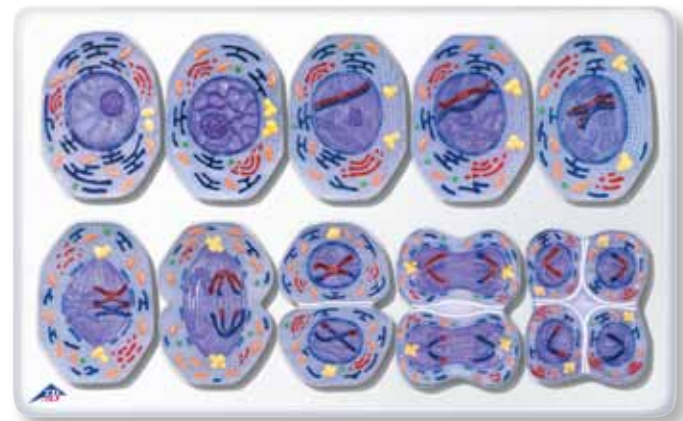

9985-1000522



9985-4006531 –
 9985-1001179 +

You will find our large selection of Charts starting on page 108.

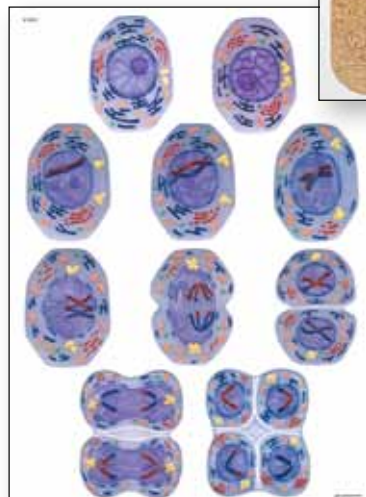

9985-4006548 –
 9985-1001206 +

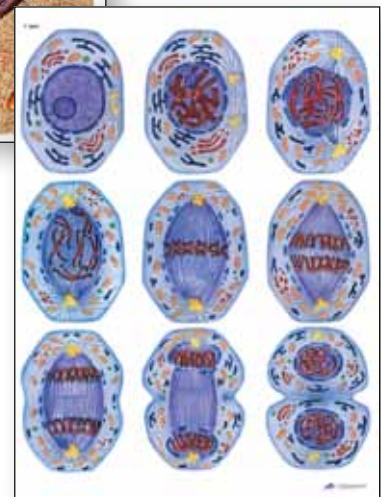

9985-4006550 –
 9985-1001210 +

Glass Cell, 40,000 times full-size

This unique model represents an undifferentiated human cell at an enlargement of 40,000 times. It provides a means of studying the structure of the smallest unit of any living creature capable of independent life, as seen through an electron microscope. The model shows the essential function bearing cell organelles. Their arrangement in the model provides a momentary snapshot of the dynamic balance of a cell. The cell nucleus, a few mitochondria and the lysosomes are shown in section, so that their internal structure is visible. The glass cell is an eye catcher in many exhibitions and has received several distinctions such as "World Didac Gold Award 1990".

Mounted on bar stand.

60x46x46 cm; 13.0 kg

 D/E/F/S

9985-1008554

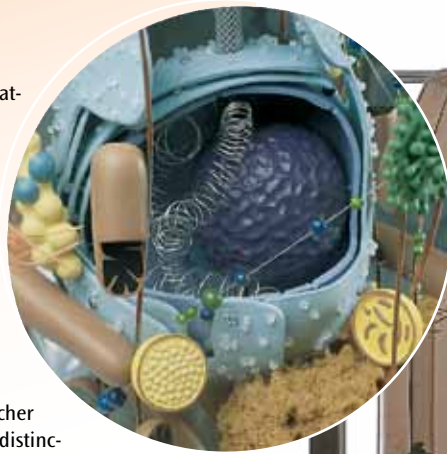

9985-1008554

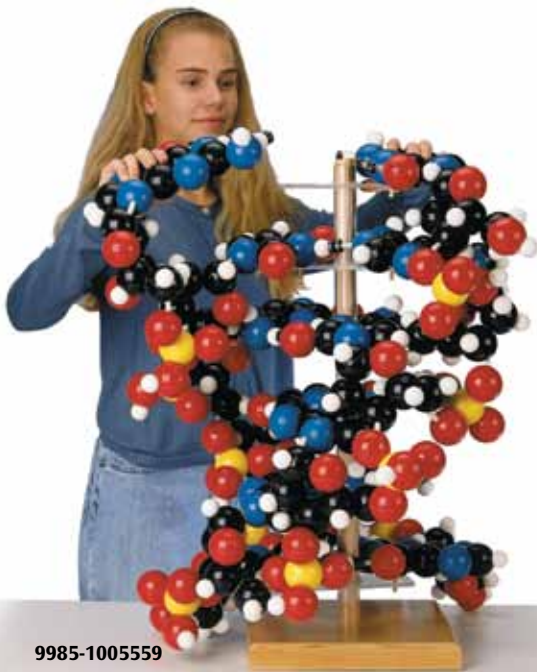

9985-1005559

DNA Double Helix

3 coils of the DNA double helix, consisting of nucleic acids, to demonstrate base pairing. At the top end is attached one RNA cord, to show the basis of transcription. On base.

31x9x9 cm; 0.2 kg

 E

9985-1005128



9985-1005128

You will find our large selection of Charts starting on page 108.

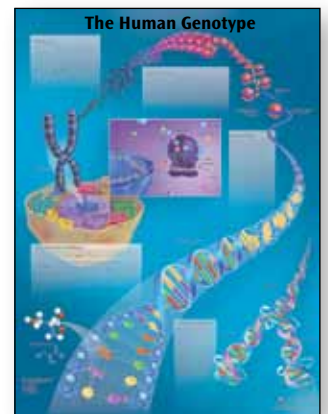

9985-4006717 *

9985-1001600 **

Giant DNA Model

At nearly 90 cm in height, this DNA Molecule is ideally suited to the classroom environment. Magnetic connectors, representing hydrogen bonds, permit the two strands of the double helix to unzip completely, evoking the mechanism of DNA replication, and RNA synthesis (genetic transcription). Removable nucleotides let students experience first hand why a larger purine base must always pair with a smaller pyrimidine base, and that base pairs are complementary – adenine pairing with thymine and guanine pairing with cytosine. Non separable atoms connected by permanent flexible "bonds" form the sugar-phosphate backbone of the molecule. Encompassing six base pairs the double helix is mounted on a wooden base and can be rotated.

86x41 cm; 8.62 kg

 E

9985-1005559



9985-1002489
3B MUSCLEtrainer™
 ISBN 978-3-8294-0003-9

9985-1002491
3B NEUROtrainer™
 ISBN 978-3-8294-0004-6

9985-1002487
3B ANATOMYtrainer™
 ISBN 978-3-8294-0005-3

3B MUSCLEtrainer™ – Master the muscles in the blink of an eye!

Do you need to learn all about the human muscle system? Then the 3B MUSCLEtrainer™ is just what you require. With it's 248 high quality digital images, 241 muscles and more than 200 associated anatomical structures, the 3B MUSCLEtrainer™ is the ideal tool to help you revise for your exam or simply refresh your knowledge.

Optimal Exam Preparation:

- Over 440 different muscles and structures
- Origin, insertion, innervation and function can be displayed

Interactive Quiz Function with:

- Variable quiz parameters
- Number of attempts
- Time pressure
- Immediate and systematic quiz evaluation
- Long term graphic learn control over all areas

Additional Highlights:

- 5 language version: English, French, Spanish, Portuguese, German, (Latin)

Info about:

- Spinal nerve segment
- Associated joints
- Important clinical and sports aspects
- Zoom to 200% – no interpolation!
- Fully hyperlinked index
- Runs directly from CD-ROM

Excellent for medical, physiotherapy and sport science students, sport and fitness trainers, healthcare professionals, etc.

9985-1002489

3B ANATOMYtrainer™ – Clever Way to Pass your Examinations

Are you training to become a doctor, dentist, physiotherapist etc.? Then the 3B ANATOMYtrainer™ is the right tool to help you achieve your ambitious goal. Almost 400 high resolution digital images and almost 3,000 exam relevant anatomical structures give you fast access to human anatomy. Furthermore, the unique structure of the 3B ANATOMYtrainer™ helps you organize your study time, allows you to perform complex test routines, immediately analyzes your results and monitors your long-term learning progress.

NEW:

- Any number of memo boxes can be saved as a study list and reopened at a later point in time – this allows you to adapt the subject areas for study even more specifically to your needs
- The study lists can be exchanged among different users of the 3B ANATOMYtrainer™ 2.0 – ideal support when preparing for exams!
- Extensive printing functions for the illustrations, lists of terms, memo box, etc.

Optimal Exam Preparation:

Unique new quiz function with selectable parameters such as:

- Subject areas to be tested
- Time pressure
- Number of attempts
- Multiple choice mode (what is it?)
- Location questions (where is it?)
- Instantaneous and systematic analysis of quiz results
- Organization of revision tasks with long term progress evaluation

Additional Highlights:

- 5 language version: English, French, Spanish, Portuguese, German, (Latin)
- 3D selection figure
- Zoom to 200% – no interpolation
- Fully hyperlinked index
- Extra glossary with over 300 general terms explained
- Runs directly from CD ROM, no installation necessary

9985-1002487

3B NEUROtrainer™ – Quick Help for Clever Students

Do you want to study the structures of the brain without going crazy? Then the 3B NEUROtrainer™ is the right program for you. Over 800 anatomical terms and 110 accurate illustrations are waiting to be interactively used by you throughout this complex field of human anatomy. The unique quiz function and the clearly organized status of our study progress allow for steady planning of your objectives. Therefore, together with the lectures and prep course, the NEUROtrainer™ provides optimal support for exam revision.

Optimal Exam Preparation:

Unique new quiz function with selectable parameters such as:

- Subject areas to be tested
- Number of attempts and time pressure
- Multiple choice mode (what is it?)
- Location questions (where is it?)
- Instantaneous and systematic analysis of quiz results
- Organization of revision tasks with long term progress evaluation
- Direct access to quiz from memo box
- Exchange of quiz and study lists

Additional Highlights:

- 5 language version. English, French, Spanish, Portuguese, German, (Latin)
- Extensive printing functions
- Zoom to 200% – no interpolation
- Fully hyperlinked index
- Extra glossary with over 300 general terms explained
- Runs directly from CD ROM, no installation necessary

9985-1002491

System requirements for 9985-1002487, 9985-1002489, 9985-1002491 and 9985-1004881

Windows: 98/NT/2000/ME/XP*

Pentium processor 200 MHz, 64 MB RAM, 8x CD-ROM drive, monitor resolution 640 x 480, 32.000 colours (16 Bit), sound card (*not applicable for 9985-1004881)

Macintosh: Power PC, Mac OS 7.5 / 56 MB free RAM

8 x CD-ROM drive, monitor resolution 640 x 480, 32.000 colours (16 Bit)

Sorry, returns cannot be accepted once item has been opened.



9985-1004881
ISBN 978-3-8294-0001-5

CD-ROM Histopathology, English (Macintosh/Windows)

This presentation of a histopathology course unites the view of microscopic illustrations with spoken explanations in a handy manner. The program accompanies medical students through the entire course of histopathology but it also allows the experienced practitioner to revise basic knowledge.

9985-1004881

3B NEUROtables™

On 21 pages with over 60 detailed illustrations the 3B NEUROtables™ reveal the human brain in various views and sectional layers. The anatomical structures of the individual illustrations are numbered and named on each page. The 3B NEUROtables™ cover the following areas: Brain, spinal medulla, brain stem, brain stem centre and cerebellum, diencephalon, cerebrum, cerebral nerves, vessels and ventricular system, functional systems. Printed on size A4, tear-resistant, washable plastic with spiral binding. 30.5 x 23 x 0.5 cm; 0.25 kg

Art. No.	3B NEUROtables™
9985-1002492	German ISBN 978-3-8294-0007-7
9985-1002493	English ISBN 978-3-8294-0008-4
9985-1002494	French ISBN 978-3-8294-0009-1

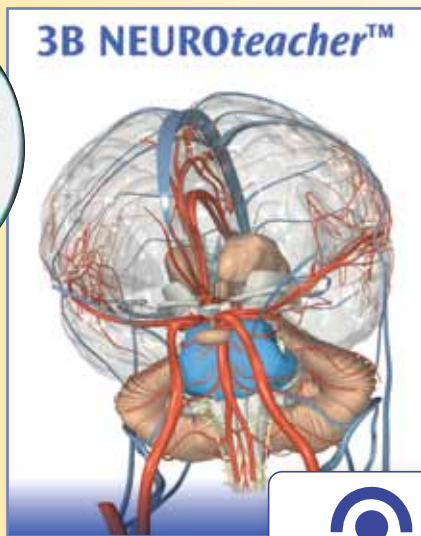

9985-10106



Unique Worldwide – the 3B NEUROteacher™

The 3B NEUROteacher™ is a unique worldwide lecture program on DVD-ROM to assist you in preparing and giving lectures in the field of neuroanatomy. You can either edit the available lectures and adapt them to your individual needs or design new ones. Topographical anatomy and morphology, functional systems and vessels of the CNS are shown in 74 different 3D media objects (3D images and animations) with over 800 structures labelled. The 3D images can be rotated freely and can be shifted or zoomed. When the mouse is rolled over a structure, the structure is labelled. When a structure is selected from the list, the image will automatically rotate to reveal the structure. The structure itself is displayed either in Latin or in the user language (English, German, French, Portuguese or Spanish). Lectures can even be made available to students via network or collected on your laptop for use in external lectures or presentations.

You can order the DVD-ROM with the full version of the 3B NEUROteacher™ free of charge for a 7-day testing period.

The DVD-ROM includes around 5 gigabytes of teaching material. A library includes the 74 labeled 3D media objects and 10 ready prepared classic lectures:

- Highlights
- The CNS (Neuraxis)
- The Brain (Encephalon)
- Spinal Cord, Brainstem and Cerebellum
- The Diencephalon
- The Cerebrum
- The Cranial Nerves
- Ventricular System and Arteries
- The Motor System
- Sensory Systems

The 3B NEUROteacher™ supports the usage of a broad pallet of file formats:

- Graphic format: .bmp; .jpg; .gif; .tif; .psd; .pct; .tga; .png
- Multimedia: .swf; .dir; .dvr; .dcr
- Video format: .mov (QT 2, 3, 4); .avi
- Audio format: .wav; .mp3; .aif; .au; .swa
- Text format: .htm; .txt; .rtf

3B NEUROteacher™, Single User License

9985-10106

3B NEUROteacher™, Fifteen User License

9985-10107

System Requirements for 3B NEUROteacher™:

- **Windows:** Windows 98/ME/NT4 (SP3)/2000, Processor: Intel Pentium III or compatible, 450 MHz, RAM: 128 MB
- **Macintosh:** Mac OS 8.1 or higher, MAC OS X not yet supported, Processor: Power PC, G4; RAM: 80 MB available
- **Monitor resolution:** 800 x 600 pixels, colour depth 16 Bit, high colour, 3D graphic card recommended



The New LIEDER Program of Interactive CD-ROM

We offer a new range of CD-ROM for interactive learning and teaching in school and higher education. All pictures and illustrations are taken from our own stocks to provide superior quality. Newly developed programs guarantee easy installation and unproblematic running. Every CD comprises the following topics:

- Comprises a great variety of beautiful diagrams, colour photos, tables, anatomical pictures, electron and X-ray photographs, impressive life cycles, human photographs, landscape photographs, scenes, test data and results, necessary for teaching the subjects.
- Comprises all necessary photomicrographs of microscopic slides, which can be observed by five different steps of magnification by using a "MicroScope". The slides can be moved under this microscope and can be observed in all its parts.
- Comprises all necessary drawings matching the pictures, with explanations of all the parts.
- The same number of comprehensive explanatory texts to help understanding the pictures.
- A special test program to check the students' knowledge in several levels of difficulty. A variable number of random selected pictures have to be identified. After a successful run the students receive notes about their progress in learning. By repeating the test any improvement will be revealed by the program.
- A comprehensive index, a search function and a user friendly browser for all pictures and texts on every CD-ROM.
- All pictures can be shown in full screen size, just by pressing the ENTER button.
- Special accompanying material, which enables evaluation of what has been seen, and creative learning is an important part of the program. Drawings, sketches and worksheets are supplied for many of the pictures on the CD.
- The novel demo program features the functionality to start a self running demo of the program in sequential or random order.
- The complete set of images on this CD can be displayed in thumbnail view for a comprehensive overview of all available material.
- A comprehensive index. The entire set of material, that is, pictures, supplemental texts and slides, and drawings, are accessible via the main program's dropdown menu.
- The texts will be provided in several languages by pre-selection when starting the program.
- All pictures and texts can be printed by the user.
- The CD works with all Windows versions (WINDOWS™ 95, 98, NT, 2000, XP and VISTA). The resolution is 960 x 640 or higher for superior quality. Full colour representation with over 1 Million colours (depending on the screen).

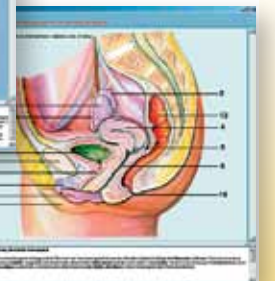
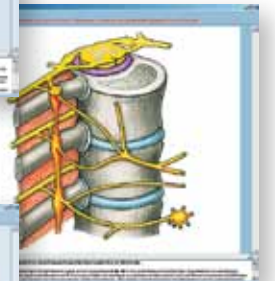

Histology of Man and Mammals

9985-1004273

Human Parasites and Diseases

9985-1004274

Feeding Organs and Metabolism in the Human Body

9985-1004275

Sense Organs as a Window to the World

9985-1004276

Human Skeleton, Musculature and Apparatus of Movement

9985-1004277

The Human Respiratory and Circulatory Systems, the Human Heart

9985-1004278

Reproduction and Sex Instruction

9985-1004279

Nervous System and Transmission of Information, Part I

9985-1004280

Nervous System and Transmission of Information, Part II

9985-1004281

Hormones, Hormone System and Control

9985-1004282

Heredity and Genetics of Man, Part I

9985-1004283

Heredity and Genetics of Man, Part II

9985-1004284



9985-1003660



9985-1005094
9985-1005095

“Benny” – The Anatomical Teddy®

Does this problem sound familiar: You try to explain to a small patient facing surgery why an operation has to be done and where the organ to be operated on is located, but all you look into is a pair of blank and frightened eyes? Benny is a hand made teddy bear and will help you and your little patients to explore the methods of examination and surgery in an easily comprehensible way!

- The zipper on the stomach can be opened from the top or bottom and simulates an operation of the abdomen and chest
- The bones of the legs and arms can be demonstrated by opening the zippers
- Spine, chest and ribs are palpable
- Artificial blood (in the form of fruit tea) can be put into 2 tubes in the arm and hand and withdrawn with a cannula

Benny is washable and his fur is made of a flame retardant polyester fibre which gives him an extra soft and fluffy touch.

50 cm; 0.7 kg

9985-1003660

Physio Baby

This cute baby doll (unisex) is ideal for training the main principals of baby care at school and in preparation courses for young parents. It allows dressing, undressing, washing, changing nappies, and many other procedures. Due to the realistic size of a newborn infant you can use ordinary baby clothes. Limbs, head and waist are flexible so that you can also practice baby gymnastics and physiotherapy exercises.

48 cm; 1.0 kg

Art. No.	Physio Baby
9985-1005094	With Male Clothes
9985-1005095	With Female Clothes



Down's Syndrome Doll (Trisomy 21)

The Down Syndrome Doll was designed to promote self acceptance and self identification of children with Down's Syndrome. They are available with their mouths open or closed. A doll with a closed mouth will encourage children to keep their tongues in their mouths. The doll is ideally suited and educationally beneficial as a toy for non disabled children. Learning from play and appreciating the environment contributes to better understanding and acceptance of people with disabilities. The Down's syndrome doll displays the following typical features: Open mouth, round face, short hands, characteristic eyes, widened space between first and second toes. 45 cm; 0.5 kg

Art. No.	Down's Syndrome Dolls
9985-1003661	Kim – Caucasian Down's Syndrome Doll, male, with closed mouth
9985-1003662	Betty – Caucasian Down's Syndrome Doll, female, with open mouth
9985-1003663	Salomon – Down's Syndrome Doll, African male, with closed mouth
9985-1003664	Naomi – Down's Syndrome Doll, African female, with open mouth
9985-1003665	Maria – Down's Syndrome Doll, Latin female, with open mouth
9985-1003666	Lin – Down's Syndrome Doll, Asian female, with closed mouth, not shown

9985-1000340



9985-1000341

Condom Training Model, White Skin Tone

This model of an erect penis with testicles is used to quickly learn how to use a condom safely. The anatomical structures and its firmness are absolutely realistic, so that your students can learn to put on and remove a condom in a realistic way. Supplied with 12 dry training condoms and a carrying bag. 7.5x7.5x19.5 cm; 0.35 kg
E/D/S/F/P/I/J www.3b.com

9985-1000340



9985-1005560

Condom Training Model

Demonstrate the proper use of condoms by using this realistic model. Consists of an erect penis, 12 condoms, syringe and artificial semen (UV-fluorescent fluid) to simulate ejaculation. Mounted on a stand with suction cups and supplied with carrying bag. 35.5x15x16.5 cm; 2.3 kg
E

9985-1005560



9985-1005115

Condom Training Models

These low priced Styrofoam models are excellent for use in larger group lessons and can be reused several times. The models can be fixed to the desktop with adhesive tape, so that both hands are free for rolling the condom into position. Supplied without condoms. 14.5 cm

9985-1005115



9985-1000339

Training Model for a Female Condom

This model shows the labia and vagina up to the cervix in a simplified representation for didactic reasons, and is used for demonstrating and learning the insertion of a female condom. Supplied with one Femi-dom condom. 12 cm; 0.15 kg

9985-1000339

Dark skin

9985-1000338

Condom Training Model, Coloured Skin Tone

Like 9985-1000340.

9985-1000341

AIDS Virus

This model of the HI-Virus, enlarged millions of times, shows the outer lipid membrane with protein structures, and the internal nucleus which contains the viral hereditary matter (RNA). The nucleus is removable and condoms can be put inside to provide a message regarding measures to take in protecting against HIV. Supplied without condoms. Mounted on base. 18x13x13 cm; 0.7 kg

9985-1000336



9985-1000336

Options and Replacements for 9985-1000340, 9985-1000341 and 9985-1005115

12 Dry Condoms

9985-4007214

Options and Replacements for 9985-1005560

12 Dry Condoms

9985-4007214



9985-1005826

Female Condom Model

This model represents an anteverted uterus in a simulated pelvic cavity with soft vulva and vagina and a soft plastic stomach cover. A perfect tool to demonstrate the use of a female condom, contraceptive sponge and cervical cap. Supplied with carrying bag. 17.8x24x14 cm
E

9985-1005826

Family Planning Educator

Desktop simulator for training and demonstration of: introduction and removal of a diaphragm, an IUD or sponge contraception devices; normal and abnormal uterine positions; bi-manual examination technique. Supplied with: one anteverted uterus with clear upper half to illustrate correct position of IUD; one uterus to illustrate normal anteversion and retroversion; cervix with patent os attaches to uterus suspended within pelvic cavity; soft plastic stomach cover; carrying bag.
E

9985-1005784



9985-1005784

Options and Replacements for 9985-1005784 and 9985-1005560

Artificial Semen (UV-fluorescent fluid)

9985-1005561



9985-1005766



9985-1005825

I.U.D Trainer

Hand held trainer which is a suitable aid for understanding correct positioning of I.U.D. (Intrauterine Device) in the uterus. Made of durable plastic, the trainer features a transparent cover which allows easy visualization of insertion and placement of I.U.D. (I.U.D. not included). 6x40x45 cm
E

9985-1005766

I.U.D Trainer

This anatomically accurate model represents a section of the uterus, ovaries and fimbriae. The uterus is covered by a clear plastic window to allow easy sight of insertion and placement of I.U.D. (I.U.D. not included).
E

9985-1005825

...going one step further

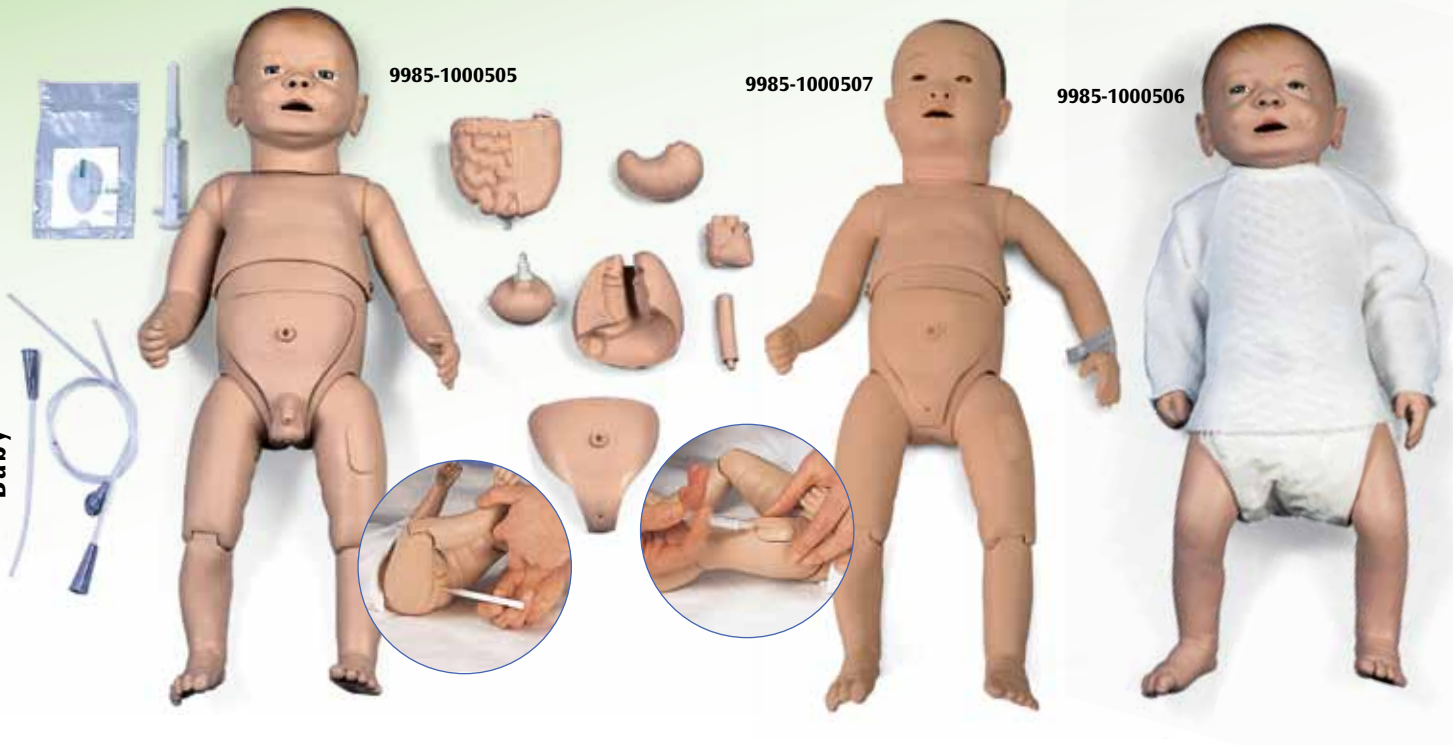

Nurse Training Baby, New Born

This advanced and incredibly realistic model (male and female) features:

- Internal organs (heart, lung, intestine system, stomach and bladder)
- Removable belly covering
- Interchangeable genital organs
- Soft ears
- Fully movable head, arms and legs

Allows trainees to practice both basic and medical infant care such as:

- Tracheotomy care
- Male and female catheterization
- Insertion of a tube into mouth or nose
- Enema insertion
- Femoral, gluteal intramuscular and subcutaneous injections
- Palpitation of fontanelles

Accessories included: syringe, suction catheter, feeding tube, urinary catheter, urine collection bag, catheter lubricant and carrying bag.

52 cm; 2.3 kg

E/D/S/F/P/I/J [www.](http://www.3bscientific.com)

9985-1000505

Deluxe Nurse Training Baby with Japanese Facial Features

Same details as 9985-1000505.

52 cm; 2.3 kg

E/D/S/F/P/I/J [www.](http://www.3bscientific.com)

9985-1000507

Options and Replacements for 9985-1000505/ 9985-1000507

Injection Pads for Thigh and Hip

9985-4000162

Male Baby Care Model

This baby will never lose its patience. Parents-to-be or the baby care trainee can perform bathing, changing, dressing and feeding simulation until these techniques are mastered. Very useful for ante natal classes!

52 cm; 2.3 kg

D/E/F/S/J [www.](http://www.3bscientific.com)

9985-1000506

Baby "Hippy"

Representation of the lower torso and limbs of a newborn female with:

- Dislocated left hip for practice of the Ortolani Jerk-Sign
- Lax right hip for performing the Barlow manoeuvre

30.5x25x25 cm; 2.7 kg

E

9985-1005864



9985-1000506



9985-1000506

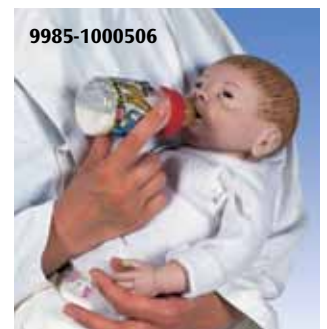

9985-1000506



9985-1005864



9985-1000508

Male Baby Care Model with Japanese Facial Features

Same details as 9985-1000506.

52 cm; 2.3 kg

D/E/F/S/J [www.](http://www.3bscientific.com)

9985-1000508



9985-1005802
with 9985-1005805

Newborn Patient Care Baby

This manikin simulates a 0-8 week old newborn with rotatable soft arms and legs. It allows training of basic and advanced paediatric patient care procedures such as:

- Bathing and bandaging
- Tube feeding and gastric suction (movable tongue)
- Heel stick and finger prick practice
- I.m. injection (upper thigh)
- Male and female catheterization
- Enema administration

Supplied with T-Shirt, nappy and carrying bag.
81x20x20 cm; 2.7 kg

E

9985-1005802

Options and Replacements for 9985-1005802

I.v. Injection Arm

Features include:

- I.v. Injections
- Radial and brachial arterial sites

E

9985-1005805



9985-1005804



Baby

Infant Patient Care Manikin

This manikin simulates a one year old infant with rotatable arms and legs (jointed elbows and knees) and articulating head. It allows training of basic and advanced paediatric patient care procedures such as:

- Bathing and bandaging
- Ophthalmic exercises
- Oral and dental hygiene
- Tube feeding and gastric suction
- I.m. injection (upper thighs)
- Tracheotomy care
- Male and female catheterisation
- Enema administration

Supplied with T-Shirt, shorts, neck brace and carrying bag.
89x38x22.5 cm; 5.0 kg

E

9985-1005804

Options and Replacements for 9985-1005804

I.v. Injection Arm

Features include:

- I.v. Injections
- Soft hand for finger prick practice
- Radial and brachial arterial sites

E

9985-1005795



Baby Care Model

This cute baby doll is ideal for training the main principals of baby care at school and in preparation courses for young parents. It allows dressing, undressing, washing, changing nappies, and many other procedures. Due to the realistic size of a newborn infant you can use ordinary baby clothes. The doll has movable joints and its eyes are slightly opened.
50 cm; 2.0 kg

Art. No.	Description	Type
9985-1005088	Baby Care Model European	male
9985-1005089	Baby Care Model European	female
9985-1005090	Baby Care Model Asian	male
9985-1005091	Baby Care Model Asian	female
9985-1005096	Baby Care Model Hispanic	male
9985-1005097	Baby Care Model Hispanic	female
9985-1005092	Baby Care Model African	male
9985-1005093	Baby Care Model African	female



Physio Baby

This cute baby doll (unisex) is ideal for training the main principals of baby care at school and in preparation courses for young parents. It allows dressing, undressing, washing, changing nappies, and many other procedures. Due to the realistic size of a newborn infant you can use ordinary baby clothes. Limbs, head and waist are flexible so that you can also practice baby gymnastics and physiotherapy exercises.
48 cm; 1.0 kg

Physio Baby, with male clothes

9985-1005094



9985-1005094
9985-1005095

Physio Baby, with female clothes

9985-1005095

Patient Care



9985-1005213 VitalSim™
Please also see page 106.



9985-1005245
9985-1005252

Nursing Kid

Nursing Kid is a training manikin realistically representing a six-year old child. He is designed for skill and scenario based training of the care and management of a variety of paediatric in-hospital patients. Skills include sound auscultation, IV cannulation, urinary catheterization, and general paediatric patient care. This child is ideal for clinical training in core paediatric in-hospital clinical skills.

Product features:

- Head with anatomical landmarks, trachea, and oesophagus along with simulated lungs and stomach allow the practice of many procedures, including NG, OG, tracheal care and suctioning, and insertion, securing and care of endotracheal tubes
- Allows for the auscultation and diagnosis of normal and abnormal heart, breath and bowel sounds when used in conjunction VitalSim™
- Bilateral deltoid, bilateral thigh, gluteal intramuscular injections possible
- Articulating IV arm allows for practice of IV cannulation, medication administration and site care and maintenance
- Presets normal and abnormal heart, breath and bowel sounds for auscultation
- Pre-programmed and instructor controlled scenarios aid in standardising teaching when used in conjunction VitalSim™

Supplied with: Full body paediatric manikin, manikin lubricant, simulated blood, hospital gown, carry case, directions for Use.

Please note that VitalSim has to be ordered separately!

122x38x31 cm

D/E/F/S/I/NL/SE/FIN/CN/J/NOR

Nursing Kid, VitalSim™ Capable

9985-1005244

Nursing Kid, Non-VitalSim™ Capable

9985-1005247

Options and Replacements for 9985-1005244 and 9985-1005247

Skin and Veins

9985-1005275



9985-1005244/9985-1005247

Options and Replacements for 9985-1005808

Injection Arm

Features include:

- I.v., i.m. and subcutaneous injections
- Soft hand for finger prick practice

81.5x20.5x20.5 cm; 2.8 kg

E

9985-1005796

Nursing Baby, non VitalSim™ Capable

The clinical skills training manikin for in-hospital infant professionals Nursing Baby is an infant manikin designed for scenario based training of the care and management of a variety of infant in-hospital patients. Training includes sounds auscultation, IV and IO skills, fontanelle assessment, urinary catheterization and general paediatric patient care.

Product features:

- Normal, bulging and depressed fontanelles for assessment and diagnosis
- Head with anatomical landmarks, trachea and oesophagus along with simulated lungs and stomach allow the practice of many procedures, including NG, OG, tracheal care and suctioning
- Bilateral deltoid and bilateral thigh intramuscular injections are possible
- Articulating IV arm and IV leg allows for practice of IV cannulation, medication administration, site care and maintenance
- Medication and fluid administration through intraosseous infusion allowed via tibia access with landmarks at the tibial tuberosity and medial malleolus
- Gastrostomy tube opening for care and feeding
- Presents normal and abnormal heart, breath, and bowel sounds for auscultation when used in conjunction VitalSim™
- Interchangeable genitalia allows for urinary catheterization with fluid return, rectal temperature simulation, and administration of suppositories
- Pre-programmed scenarios aid educators in standardizing teaching when used in conjunction VitalSim™

Please note that VitalSim™ has to be ordered separately!

E

Nursing Baby, VitalSim™ capable

9985-1005245

Nursing Baby, non VitalSim™ capable

9985-1005252

Child Patient Care Manikin

This manikin simulates a five year old child with rotatable arms and legs (jointed elbows and knees) and articulating head. It allows training of basic and advanced paediatric patient care procedures such as:

- Bathing and bandaging
- Ophthalmic exercises
- Oral and dental hygiene (articulating jaw with teeth and tongue)
- Tube feeding and gastric suction
- I.m. injection (upper thigh and deltoid)
- Tracheotomy care
- Male and female catheterization
- Enema administration

Supplied with T-shirt, shorts, neck brace and carrying bag.

119x46x48 cm; 9.1 kg

E

9985-1005808



9985-1005808
with 9985-1005796



9985-1005803



9985-1005807

Basic Patient Care Manikin, Female

Full size adult manikin with movable joints and soft fingers and toes for training important basic nursing skills such as:

- Hair care and surgical draping
- Bathing and bandaging
- Oral and dental hygiene (movable jaw with removable dentures)
- Ophthalmic care
- Ear irrigation and application of otic drops
- I.m. injection (arm and buttock)

The legs can be removed for compact storage. Supplied with neck brace. 109x56x30.5 cm; 15.5 kg

E

9985-1005803

Basic Patient Care Manikin, Male

Same features as 9985-1005620.

E

9985-1005807



9985-1005597 /
9985-1005620

Geriatric Care Manikin, I

This nursing manikin features an elderly appearance and is convertible between male and female. It allows the practice of a wide range of basic nursing skills. Skin wrinkles, reddened skin fold, a dilated pupil, a stage I decubitus sacral ulcer, a normal mole and a cancerous mole are represented. The neck and all major joints are fully movable into any natural human position. Hands and feet are made of soft, flexible material for added realism. Delivered in storage carton. The following nursing procedures can be performed:

- Prostate examination (Stage B)
- Ostomy Care (Ileostomy and colostomy lavage and suctioning)
- Tracheostomy care (lavage and suctioning)
- Placement of Naso-gastric tubes
- Oral and nasal lavage, gavage and suctioning
- Pap smears and douching
- Intramuscular Injection (arms, thigh, buttock)
- Oral hygiene (removable upper and lower denture)
- Eye irrigation
- Bed baths, hair care (washing, combing)
- Patient positioning and transfer techniques, clothing changes
- Ear irrigation and hearing aid placement
- Bandaging and wound dressing (including fingers and toes)

94x52x28 cm; 10.0 kg

E

9985-1005620

Geriatric Care Manikin, II

Besides basic nursing skills this manikin also allows the practice of male and female catheterisation. All other features same as 9985-1005620.

94x52x28 cm; 12,0 kg

E

9985-1005597



Options and Replacements for
9985-1005620 /
9985-1005807

Carrying Bag

9985-1005788



Options and Replacements for 9985-1000502

Work Set

- Vaseline
- Talcum Powder
- 1 Duodenal tube
- 1 Single-use catheter CH 14
- 1 Rectal tube CH 28
- 250 ml Lubricant
- Replacement seals and screws

9985-4000147

3B Scientific® Patient Care Manikin, I

The only manikin you need to teach and practice:

- Personal hygiene, cleaning (removable partial prosthesis)
- Lifting, mobilization
- Bandaging and wound dressing (including stump dressing)
- Irrigations (eye, ear, nose, stomach, intestine, bladder)
- Injections (intramuscular and subcutaneous)
- Naso-gastric lavage and gavage
- Oxygen treatment, artificial respiration
- Tracheotomy care
- Catheterisation (male and female)
- Ostomy care (colostomy)
- Enema administration

Our best selling patient care simulator allows practice of most training applications from basic to advanced nursing, clinical and emergency training. Made of durable, unbreakable, water-resistant plastics, it is also flexible, allowing natural movement of the arms, legs and joints. Our unique flexible waist design allows the manikin to sit upright for added realism. Lungs, heart, stomach, bladder and intestinal section are removable and fitted with drainage seals for easy cleaning. Bladder and intestinal section are absolutely watertight and connected to the external genitalia to allow catheterisation. All standard injection sites have special injection pads (6 in all) which allow repeated injections and years of use. Also included is an amputation stump to practice dressing techniques. To complete this deluxe manikin, we've included an intestine tube, catheter, duodenal probe, talcum powder, vaseline and lubricant.

174 cm; 21.0 kg

D/E/F

9985-1000502

3B Scientific® Patient Care Manikin, II

Our best-selling patient care simulator 9985-1000502 is also available as basic version without internal organs and is primarily designed for elderly care and basic patient nursing. All procedures described above can be practiced except naso-gastric lavage and gavage, internal irrigations, ostomy care, catheterisation and enema administration.

174 cm; 20.0 kg

D/E/F

9985-1000503



Options and Replacements for 9985-1000503

Upgrade Kit for 9985-1000503

Easily converts a 9985-1000503 Patient Care Manikin to a 9985-1000502 Version.
3.0 kg

9985-1000504



9985-1005606

Elderly Care Manikin, III

This nursing manikin features an elderly appearance and is convertible between male and female. It allows the practice of a wide range of basic and advanced nursing skills including catheterisation. The right i.v. arm features veins that actually roll when palpated. A realistic flashback confirms proper needle placement and the shoulder can be used for intramuscular injection training. The left blood pressure arm reproduces the five Korotkoff sounds and allows the instructor to vary systolic and diastolic levels, pulse rate, volume and auscultatory gap. All other features same as 9985-1005620 on page 103.

95.5x52x28 cm; 16.4 kg

E

9985-1005606

Patient Care Manikin

Full-size adult manikin with movable joints as well as soft fingers and toes for training of important basic nursing skills such as:

- Hair care exercises and surgical draping
- Bathing and bandaging
- Oral and denture hygiene (movable jaw with removable dentures)
- Ophthalmic exercises
- I.m. injection (arm and buttock)
- Colostomy, ileostomy, and suprapubic stoma care
- Naso-gastric lavage and gavage
- Male and female catheterisation
- Enema administration
- Vaginal douching and pap smear exercises

109x56x36 cm; 14.0 kg

E

9985-1005785



9985-1005785

Options and Replacements for 9985-1005785

9985-1005786 Arm Injection Site

9985-1005787 Buttock Injection Site

9985-1005788 Carrying Bag

Options and Replacements for 9985-1005606

Skin and Vein Kit

9985-1005647

Elderly Care and BLS Manikin

This adult manikin facilitates training of basic and advanced patient care as well as Basic Life Support functions. Features include:

- Oral and denture hygiene
- I.m. (arm and buttock), i.v and subcutaneous injection
- Ostomy care (colostomy, ileostomy, and suprapubic stoma, each connected to an internal tank)
- Naso-gastric lavage and gavage
- Male and female catheterisation
- Enema administration
- Vaginal douching and pap smear exercises
- Palpable prostate
- Breast palpation (interchangeable male and 7 abnormal female breasts)
- Amputation stump
- 2 decubitus ulcers
- Eyes open and close (one pupil is dilated)
- Regular or counter pulsation CPR (Anatomically painted outline of cardiopulmonary features)
- Mouth to mouth resuscitation
- Palpable carotid pulse
- CPR Monitor: Displays cadence and depth of compression and ventilation

Supplied with ten disposable one-piece airways, neck brace, and carrying bag.

110x56x36 cm; 25.0 kg

E

9985-1005782



9985-1005782

Options and Replacements for 9985-1005782

10 Airways

9985-1005783

9985-1005828 / 9985-1005829 / 9985-100583

Blood Pressure Training Arm

See page 127 .

CPR Computer Link

This link connects your CPR Simulators (if given as an option) to any computer having Windows 98. The interactive software features colour graphics for CPR teaching and testing stations for either adult, infant or newborn mode. Cardiac compression and airway ventilation waveforms can be monitored, saved and printed.

Supplied with carrying bag.

9985-1005822





9985-1005243/
9985-1005246

Nursing Kelly

Kelly nursing manikin was especially designed for patient care training scenarios and includes a large range of clinical diagnoses. This full body adult male manikin is excellently suited to train beginner hospital healthcare professionals.

Product features

- Head with anatomical features, trachea and oesophagus together with simulated lungs and stomach allow many procedures, including OG tube, tracheal care and suctioning.
- Using a standard stethoscope, students can auscultate normal and abnormal cardiac, lung and intestinal sounds (9985-1005213 VitalSim™ required).
- Realistic palpation and auscultation using a blood pressure arm controlled by the instructor. Adjustable systolic and diastolic pressure, auscultatory gap and volume (9985-1005213 VitalSim™ required).
- IV cannulation, medication administration, site care and maintenance are allowed in the antecubital area and the dorsum of the hand, accessing the median, basilic, and cephalic veins
- Dosed administration of medications via intramuscular injections at the deltoid, gluteal, and lateral thigh muscles.
- Realistic male and female urinary catheterization and enema procedures may be performed with fluid return
- More functions possible in conjunction with VitalSim™, with which scenarios can be created, edited and replayed. Pre-programmed scenarios assist the instructor during standard training (9985-1005213 VitalSim™ required).

Includes: adult male full body manikin, hospital gown, lubricant, assembly tools and instruction manual

E

Nursing Kelly, VitalSim™ Capable

Please note that VitalSim™ has to be ordered separately!

9985-1005243

Nursing Kelly, Non-VitalSim™ Capable

9985-1005246

VitalSim™

Using the programmable wireless or hand-held wired remote, the VitalSim™ control unit works with VitalSim™ capable manikins and task trainers to simulate ECG, sounds, blood pressure and pulses.

Sounds

- Heart sounds synchronised with programmable ECG
- Auscultated lung sounds synchronised with breathing rate, 0 – 0 BPM
- Individual lung or bilateral sound selection
- Normal and abnormal bowel sounds
- Vocal sounds – computer generated sounds, mixed with voice input (via microphone sold separately)

Blood Pressure/Pulses

- Auscultated and palpated blood pressure with brachial radial pulse control
- Pulses and Korotkow sounds synchronized with programmable ECG
- Systolic and diastolic pressures may be set individually in steps of 2 mmHg
- Auscultative Gap with on / off feature
- Pulse strength dependant on BP

Logging/Scenario Functions

Control unit can be connected to PC using USB cable for:

- Uploading and running up to ten scenarios programmed using PC Scenario Editor
 - Downloading of up to 25 logs for “after action” review / debriefing
- Includes: Control unit with battery case and batteries (6), remote control including batteries (4), manikin to unit cable, operating device to control unit cable, USB cable for connection to PC, AC adapter, software CD, carry case and directions for use.

35.6x28x18 cm; 3.6 kg

E/S/I/F/D/NL/N/SE/FIN

9985-1005213



9985-1005213

Options and Replacements for 9985-1005243 and 9985-1005246

Arterial Stick Arm

Infusible arteries designed for training the proper arterial puncture procedure for blood gas analysis

9985-1005276

Wound Care Assessment Set (Male)

9985-1005251

Nursing Anne

Designed for simulation and practice of a complete range of patient assessment and care procedures. Including sounds auscultation, vocal sounds and an updated blood pressure arm, when used in conjunction with the new VitalSim™ Vital Signs Manikin Simulator. The addition of modules for breast examination, post surgical mastectomy care and fundus massage skills makes this full body, adult female manikin the complete care doll. Full body, anatomically accurate manikin with realistic articulation. The head with anatomical landmarks, trachea and oesophagus, along with simulated lungs and stomach allow the practice of many procedures:

- Irrigation of the eye and ear (simulated)
- Application / instillation of medications in the eye, ear and nose, including nasal packing
- Mouth and denture care procedures
- Insertion and suctioning of oropharyngeal and nasopharyngeal airways
- Insertion, securing and care of endotracheal tubes
- Tracheotomy care and tracheal suctioning
- Various oxygen delivery procedure
- NG tube insertion, care, medication administration and removal
- Gastric lavage and gavage
- Nasoenteric and oesophageal tube insertion, care and removal
- Manually generated carotid pulse
- Subclavian IV, various ostomy and chest tube openings for site care and maintenance

Includes: Adult, full body female manikin, hospital gown, manikin lubricant, assembly tool kit and directions for use.

Please note that the VitalSim™ unit must be ordered separately. 108x53x48 cm; 38 kg

9985-1005212
9985-1005259



Adult

Nursing Anne Non-VitalSim™ Capable

E

9985-1005259

Nursing Anne VitalSim™ Capable

E/D/S/F/I/NL/SE//N/FIN

9985-1005212

Options and Replacements for 9985-1005212

Breast Examination Module

The Breast Exam Module facilitates training in the recognition of breast disorders, sizes of nodules, and relative locations by simulating multiple abnormalities found during breast examinations.

- Normal anatomy of female breasts
- Interchangeable abnormalities to be used with breast modules
 - Fibroadenoma
 - Cyst
 - Solid lump/ mass

E

9985-1005271



Fundus Skills and Assessment Module

The Fundus Skills and Assessment module features the normal anatomy of the status-post or post-partum female abdomen designed for training fundus assessment and massage skills.

E

9985-1005273



Mastectomy Module

The Mastectomy Module is used to practice post surgical mastectomy care procedures.

- Normal anatomy of a post operative left total mastectomy
- Surgical area skin closed with staples
- Drain tube placed just under the skin

E

9985-1005272



Wound Care and Assessment Set, Female

For further information, please go to www.3bscientific.co.uk

E

9985-1005274



Patient Care

Ideal for Teaching, Patient Education and Medical Education!

By popular demand, we have redesigned our 3B Scientific® Charts to make them more versatile. Of course, as always they dynamically illustrate and skillfully describe the most important points of a subject. No one offers more languages and hardly anyone offers a comparable selection of subjects and versions.

And now you can decide what type of chart you want. The black plastic rods with eyelets for hanging ensure the greatest possible flexibility. These practical rods are easy to handle, enable you to affix the charts to the wall inexpensively and attractively and protect the charts from damage. Simply order item number 9985-1002372 (2x50 cm) or 9985-1002373 (2x98 cm) along with the charts of your choice to receive a complete set for top and bottom. If you prefer a different mode of attachment or wish to use a decorative picture frame, the paper version supplies you with all you need – without any unnecessary and expensive frills!

Or would you prefer the laminated deluxe version? It is enhanced with a front and rear 125 micron thick film coating and is already equipped with two metal eyelets for wall attachment. Particularly long lasting, particularly durable, particularly valuable!

The Right Choice for Everyone:

Inexpensive paper version ()*

- For a skilled overview of medical subjects
- With richly detailed illustrations
- For use as a poster or with your own frame

Practical rods for the paper version

9985-1002372 (2x50 cm), 9985-1002373 (2x98 cm)

- Ideal for wall attachment
- Very easy to use
- Made of robust and long lasting plastic

*Value preserving laminated deluxe version (**)*

- For heavy duty use
- Can be written on with non-permanent markers
- Can be wiped off anytime
- Good UV resistance
- Environmentally friendly special film coating

All of the versions are printed on 50x67 cm practical poster size high quality 200 g image printing paper (exception: 9985-4006730 Body acupuncture 98x68 cm).

Also available in German, French, Spanish, Italian and Japanese (Japanese in size 30x40 cm). Some products from our range are also available in Brazilian, Portuguese and Russian. Please contact us!

The series is constantly expanded so you will soon find the anatomical wall charts you need, but haven't seen yet on these pages. If there is a subject you're missing, get in touch with us, we might already be working on it.

If not, we always appreciate good ideas.

15%
discount on orders
of 5 or more items

For quantities of 500 and above per title we can personalise your charts. Please contact us!

Practical rods for the inexpensive paper version 50 cm

9985-1002372

Practical rods for the inexpensive paper version 98 cm

9985-1002373

Laminated deluxe version





9985-4006651 *
 9985-1001468 **

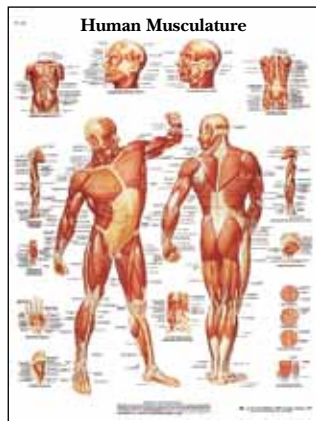

9985-4006652 *
 9985-1001470 **



9985-4006653 *
 9985-1001472 **



9985-4006654 *
 9985-1001474 **



9985-4006655 *
 9985-1001476 **

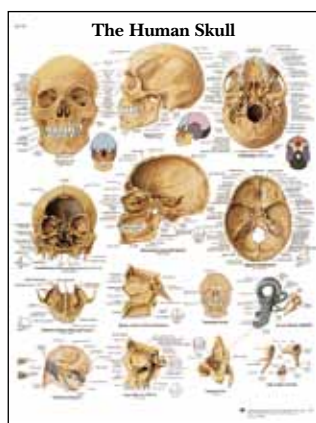

9985-4006656 *
 9985-1001478 **



9985-4006657 *
 9985-1001480 **

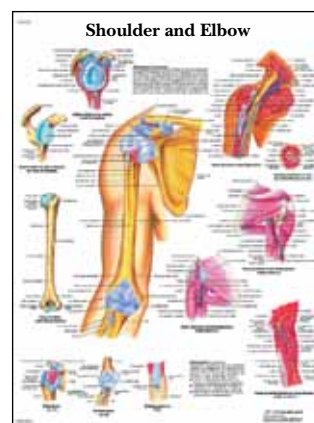

9985-4006658 *
 9985-1001482 **



9985-4006659 *
 9985-1001484 **



9985-4006660 *
 9985-1001486 **



9985-4006661 *
 9985-1001488 **

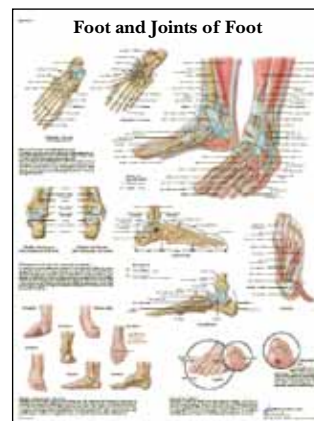

9985-4006662 *
 9985-1001490 **



9985-4006663 *
 9985-1001492 **



9985-4006664 *
 9985-1001494 **

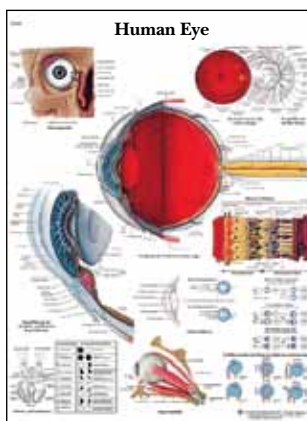

9985-4006665 *
 9985-1001496 **

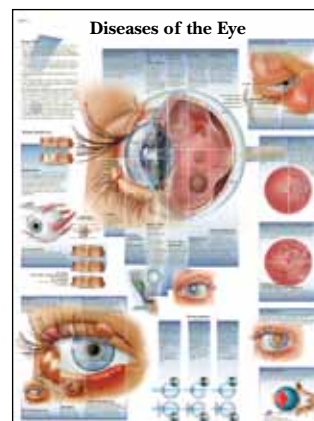

9985-4006666 *
 9985-1001498 **

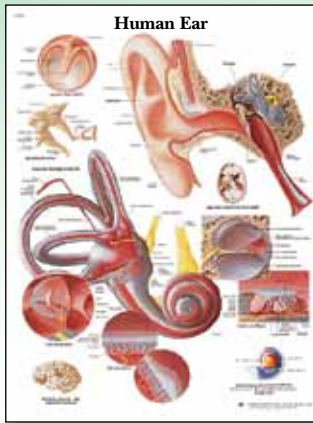

9985-4006667 *
9985-1001500 **

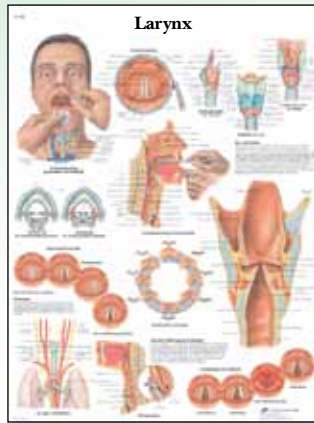

9985-4006668 *
9985-1001502 **

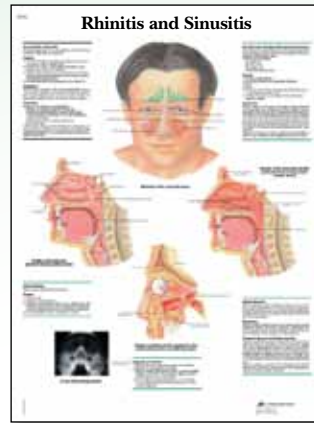

9985-4006669 *
9985-1001504 **



9985-4006670 *
9985-1001506 **



9985-4006671 *
9985-1001508 **

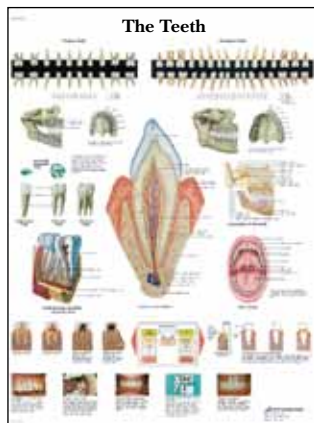

9985-4006672 *
9985-1001510 **

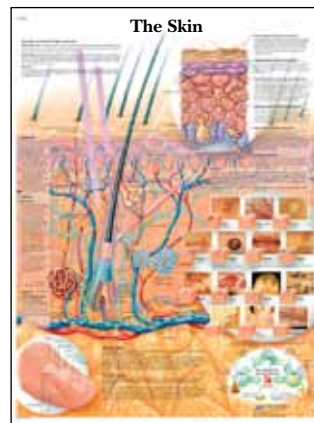

9985-4006673 *
9985-1001512 **



9985-4006674 *
9985-1001514 **

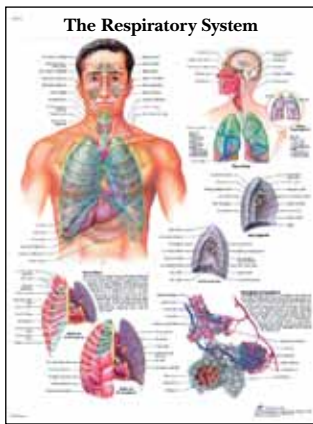

9985-4006675 *
9985-1001516 **

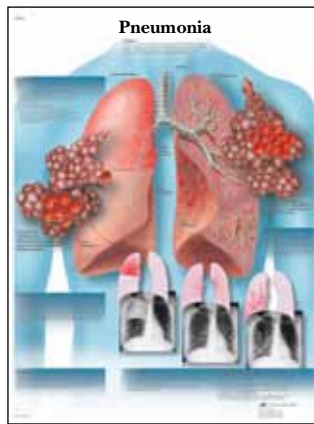

9985-4006676 *
9985-1001518 **



9985-4006677 *
9985-1001520 **



9985-4006678 *
9985-1001522 **

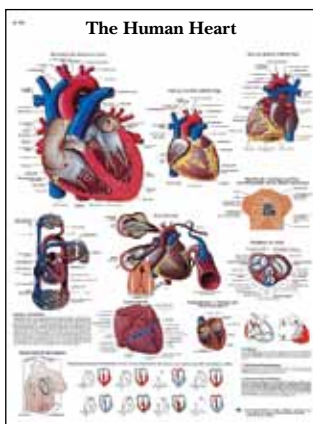

9985-4006679 *
9985-1001524 **

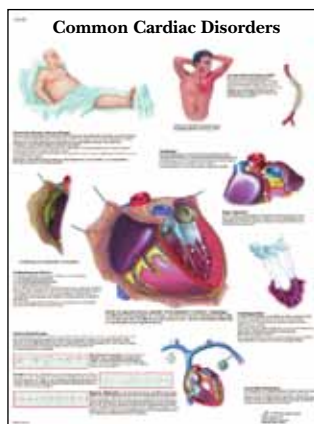

9985-4006680 *
9985-1001526 **



9985-4006681 *
9985-1001528 **

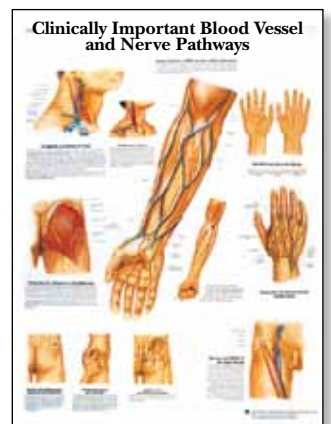

9985-4006682 *
9985-1001530 **

Charts 50 x 67 cm



9985-4006683 *
 9985-1001532 **

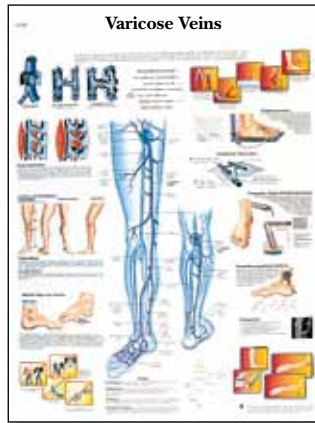

9985-4006684 *
 9985-1001534 **



9985-4006685 *
 9985-1001536 **

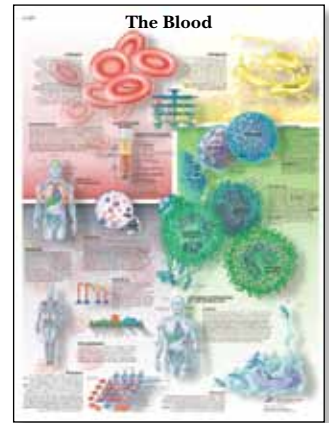

9985-4006686 *
 9985-1001538 **

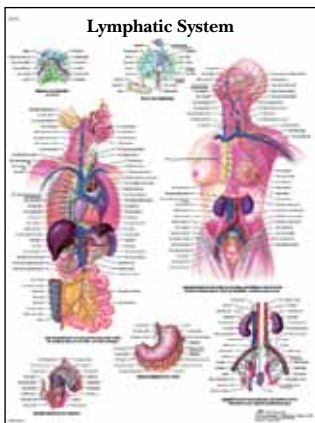

9985-4006687 *
 9985-1001540 **



9985-4006688 *
 9985-1001542 **

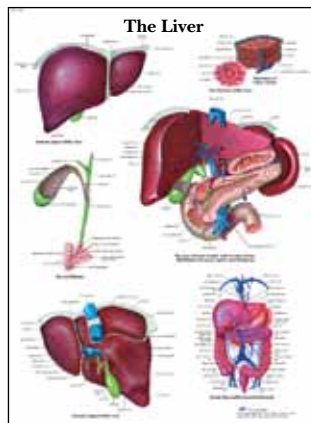

9985-4006689 *
 9985-1001544 **



9985-4006690 *
 9985-1001546 **



9985-4006691 *
 9985-1001548 **

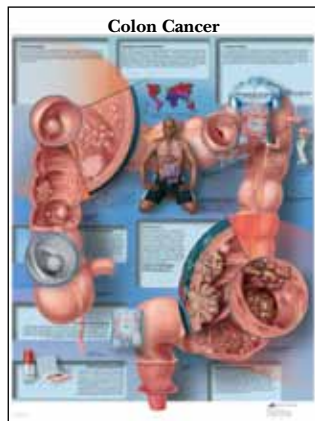

9985-4006692 *
 9985-1001550 **

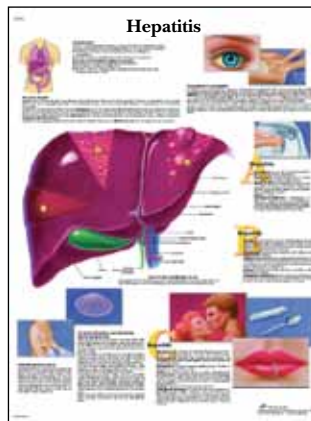

9985-4006693 *
 9985-1001552 **

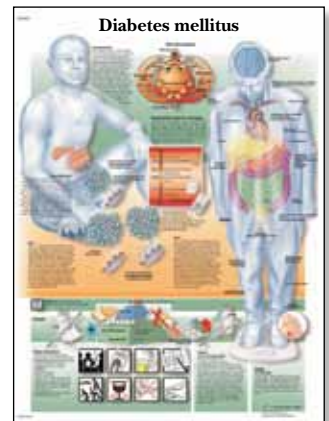

9985-4006694 *
 9985-1001554 **

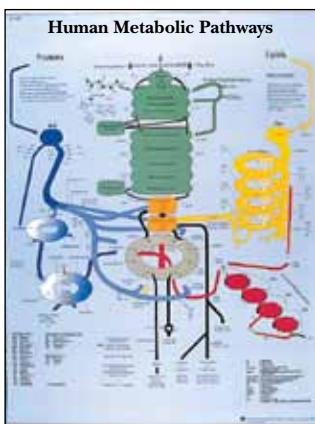

9985-4006695 *
 9985-1001556 **



9985-4006696 *
 9985-1001558 **



9985-4006697 *
 9985-1001560 **

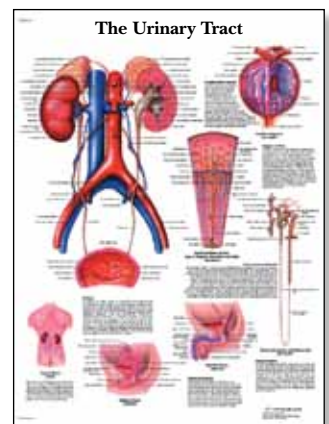

9985-4006698 *
 9985-1001562 **



9985-4006699 *
9985-1001564 **



9985-4006700 *
9985-1001566 **

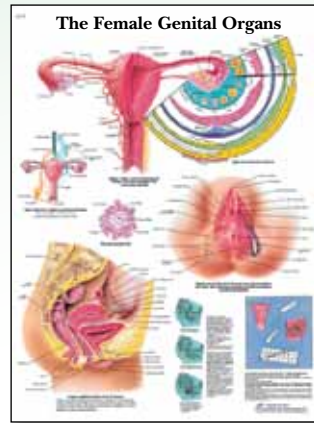

9985-4006701 *
9985-1001568 **



9985-4006702 *
9985-1001570 **

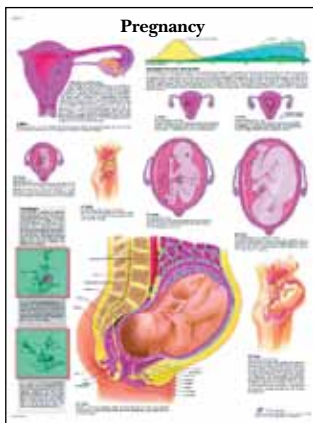

9985-4006703 *
9985-1001572 **

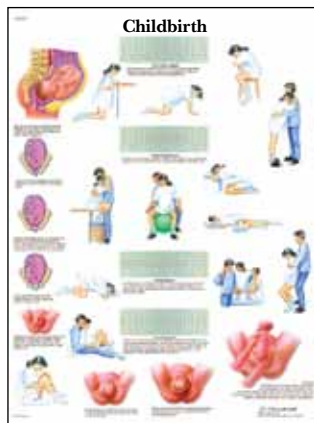

9985-4006704 *
9985-1001574 **

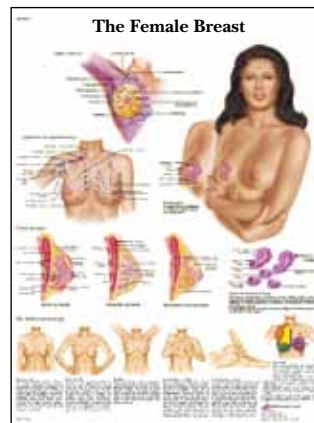

9985-4006705 *
9985-1001576 **



9985-4006706 *
9985-1001578 **



9985-4006707 *
9985-1001580 **



9985-4006708 *
9985-1001582 **

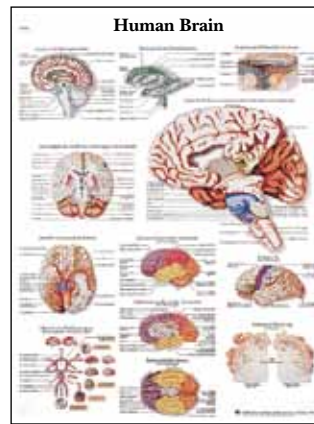

9985-4006709 *
9985-1001584 **



9985-4006710 *
9985-1001586 **



9985-4006711 *
9985-1001588 **

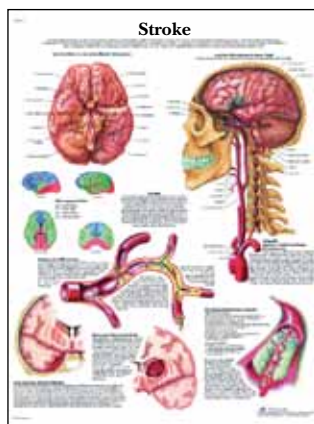

9985-4006712 *
9985-1001590 **



9985-4006713 *
9985-1001592 **



9985-4006714 *
9985-1001594 **

Charts 50 x 67 cm

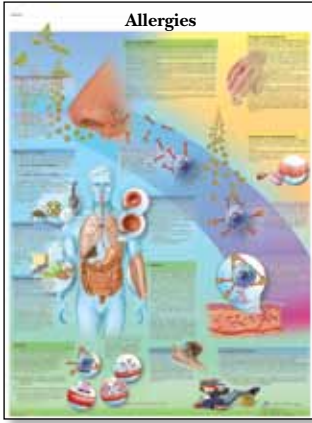

9985-4006715 *
 9985-1001596 **

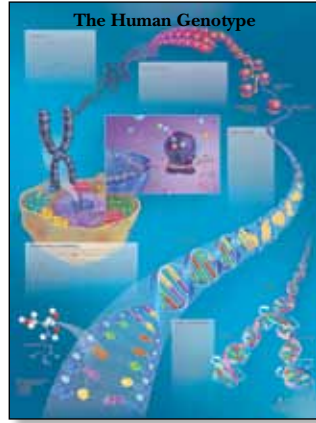

9985-4006717 *
 9985-1001600 **

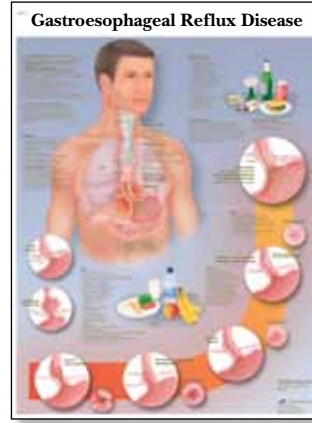

9985-4006718 *
 9985-1001602 **

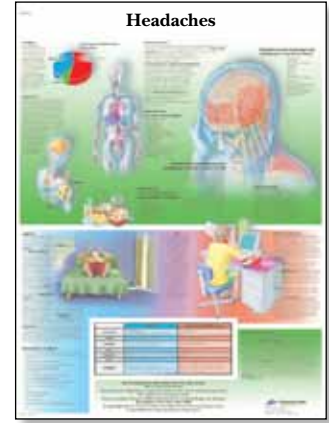

9985-4006719 *
 9985-1001604 **



9985-4006720 *
 9985-1001606 **



9985-4006721 *
 9985-1001608 **

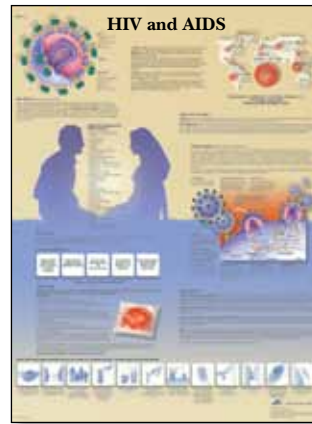

9985-4006722 *
 9985-1001610 **

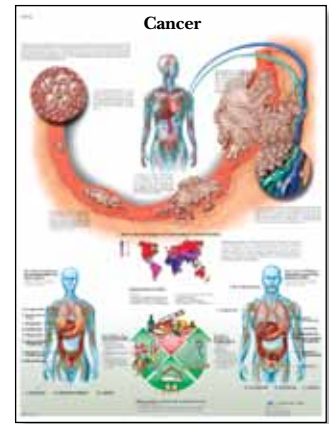

9985-4006723 *
 9985-1001612 **

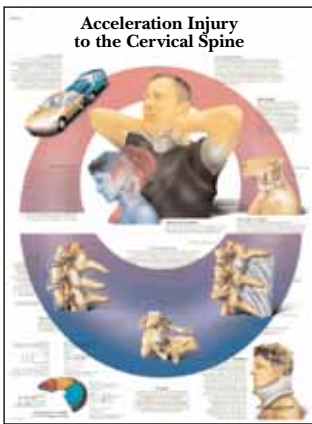

9985-4006724 *
 9985-1001614 **



9985-4006725 *
 9985-1001616 **



9985-4006726 *
 9985-1001618 **



9985-4006727 *
 9985-1001620 **



9985-4006728 *
 9985-1001622 **

If there is a subject you're missing, get in touch with us, we might already be working on it. If not, we always appreciate good ideas.

15%
 discount on orders
 of 5 or more items

* Inexpensive paper version
 ** Value preserving laminated deluxe version



9985-4006729 *
 9985-1001624 **



9985-4006731 *
 9985-1001628 **

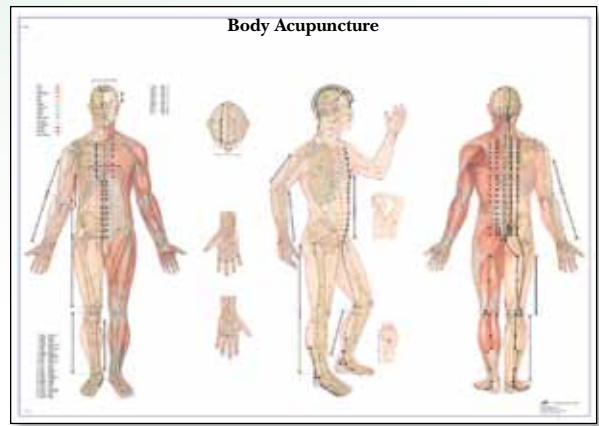

Size: 98x68 cm
 9985-4006730 *
 9985-1001626 **

For presentation and storage of your charts

Chart Display Stand including including all 82 English anatomical charts (L-versions)

9985-1002381

Practical Chart Display Stand for storage of laminated charts

9985-1002376



9985-1002381
 9985-1002376

Anatomical Wall Charts

A valuable educational supplement for schools, universities and medical facilities. These impressive anatomical wall charts are supplied with a detailed six language product manual and scientifically correct nomenclature. They are printed on waterproof, tear resistant paper and are available with (+) or without (-) wooden rods in two different sizes.

Dimensions: 84x118 cm
 Dimensions: 84x200 cm

L/E/D/F/S (partially I/P/R/C)

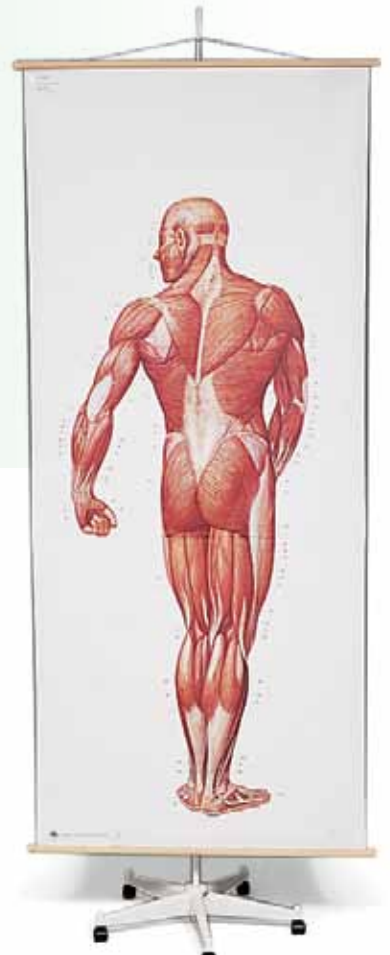

9985-1000520

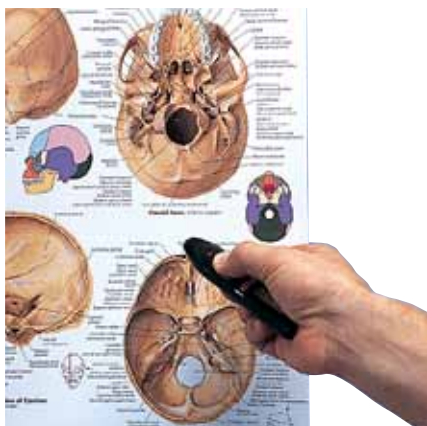

9985-1013170

Special Mobile Stand with Brake

We recommend this helpful stand for displaying the anatomical wall charts.

9985-1000520

Laser Pointer

This safe Laser Pointer (laser safety class II) with its convenient pen shaped design assists your lessons with 3B Scientific® Charts. The red beam spot will stay small and sharp even in daylight and from large distances. A convenient aid for any teacher.

9985-1013170

Charts 50 x 67 cm / 98 x 68 cm

The Human Skeleton, front

9985-4006512 –
9985-1001146 +

The Human Skeleton, rear

9985-4006513 –
9985-1000012 +

The Vascular System

9985-4006515 –
9985-1001151 +

The Human Musculature, front

9985-4006514 –
9985-1001149 +

The Human Musculature, rear

9985-4006516 –
9985-1001153 +

The Nervous System, front

9985-4006539 –
9985-1001190 +

The Nervous System, rear

9985-4006540 –
9985-1001192 +

Size: 84x200 cm

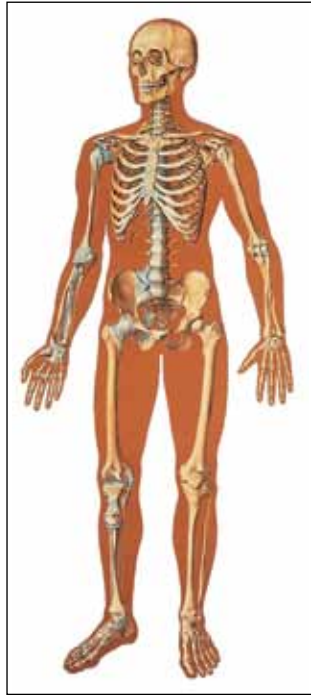

9985-4006512 –
9985-1001146 +

Size: 84x200 cm



9985-4006513 –
9985-1000012 +

Size: 84x200 cm

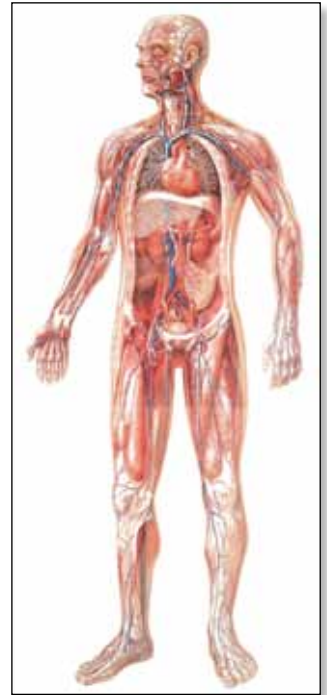

9985-4006515 –
9985-1001151 +



9985-4006514 –
9985-1001149 +

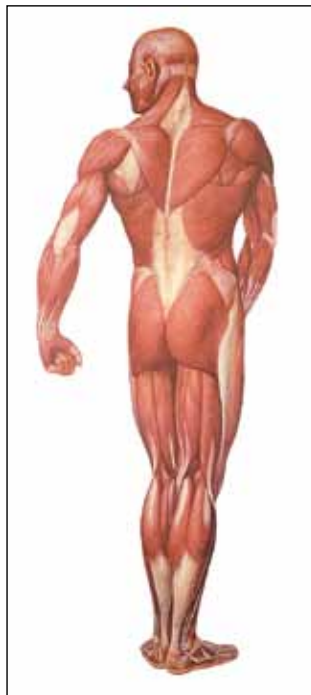

9985-4006516 –
9985-1001153 +



9985-4006539 –
9985-1001190 +



9985-4006540 –
9985-1001192 +

Size: 118x84 cm

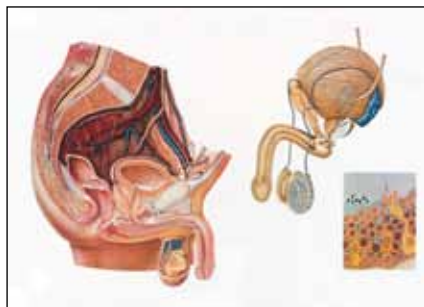

The Male Pelvic Organs

9985-4006527 –
9985-1001173 +

Size: 118x84 cm

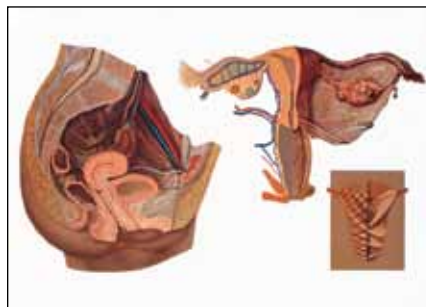

The Female Pelvic Organs

9985-4006528 –
9985-1001175 +

Size: 118x84 cm

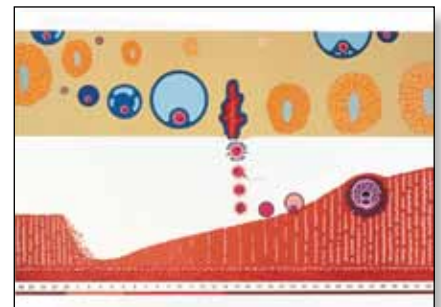

Menstrual Cycle and Ovum Implantation

9985-4006559 –
9985-1001220 +

Large Charts 84 x 200 cm / 118 x 84 cm

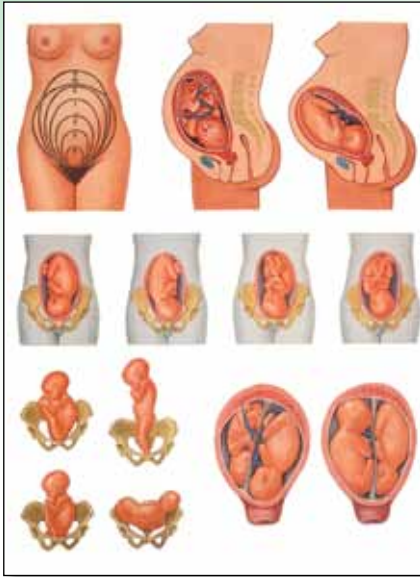

Position of the Child before Birth
 9985-4006562 –
 9985-1001226 +



The Birth Process
 9985-4006547 –
 9985-1001204 +

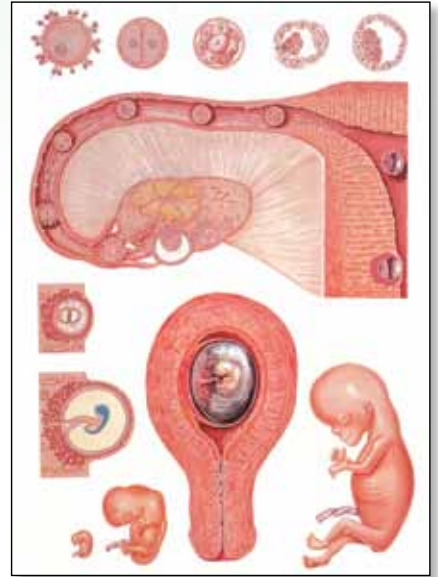

Embryology I
 9985-4006560 –
 9985-1001222 +

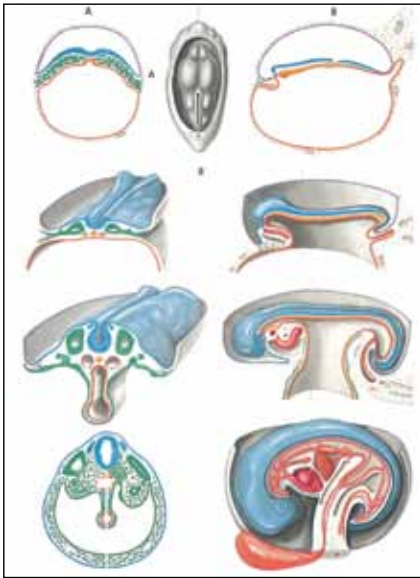

Embryology II
 9985-4006561 –
 9985-1001224 +

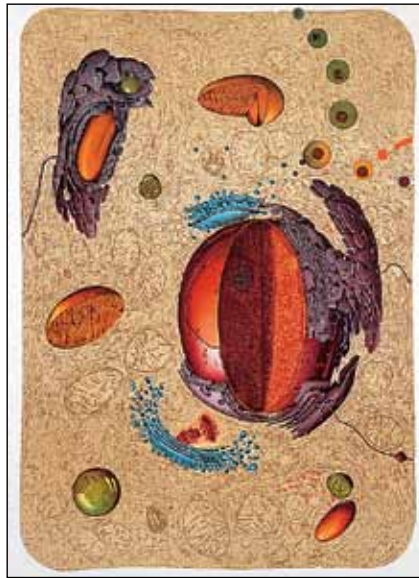

Human Cell Structure
 9985-4006531 –
 9985-1001179 +



Cell Division I, Mitosis
 9985-4006548 –
 9985-1001206 +

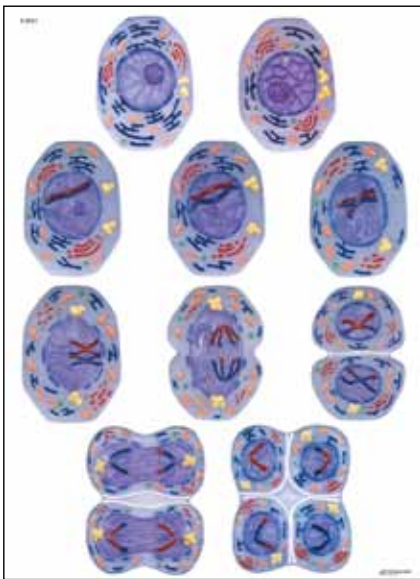

Cell Division II, Meiosis
 9985-4006550 –
 9985-1001210 +

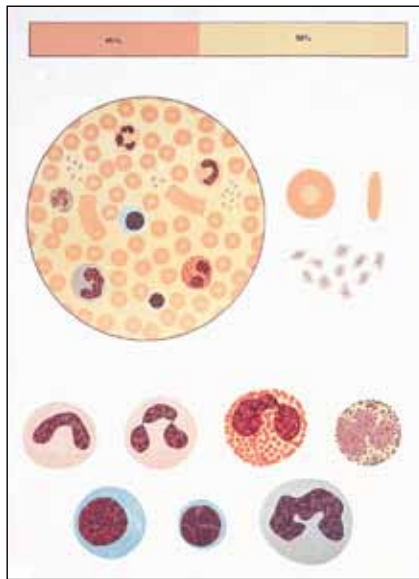

The Blood, Composition
 9985-4006534 –
 9985-1001183 +

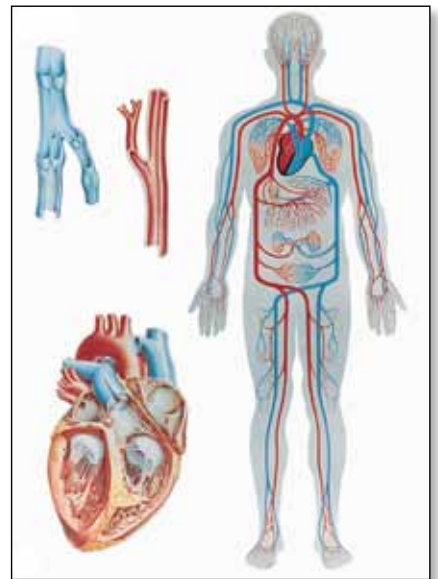

Human Blood Circulation
 9985-4006525 –
 9985-1001169 +



The Skin
9985-4006530 –
9985-1001177 +

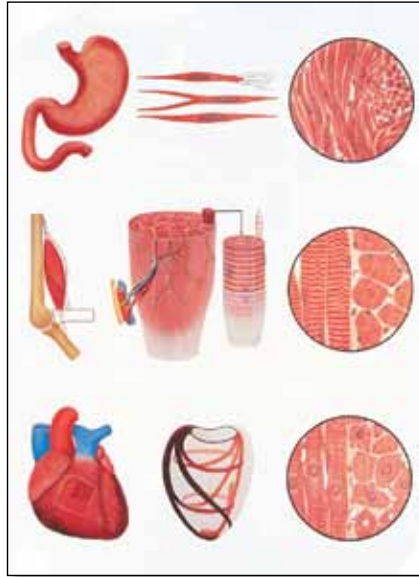

Muscle Tissue
9985-4006551 –
9985-1001212 +

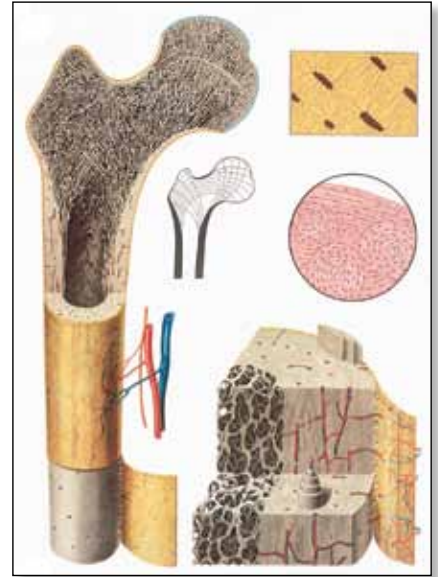

Bone Structure
9985-4006549 –
9985-1001208 +

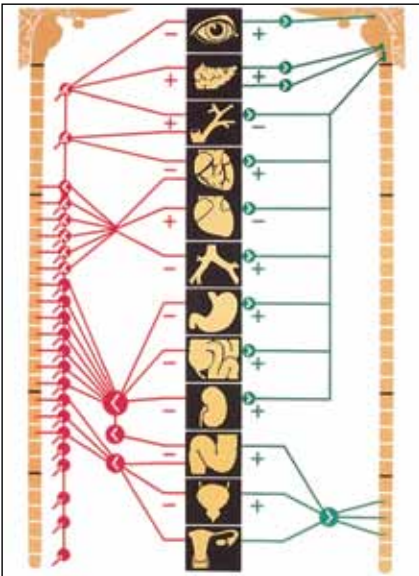

The Vegetative Nervous System
9985-4006556 –
9985-1001218 +

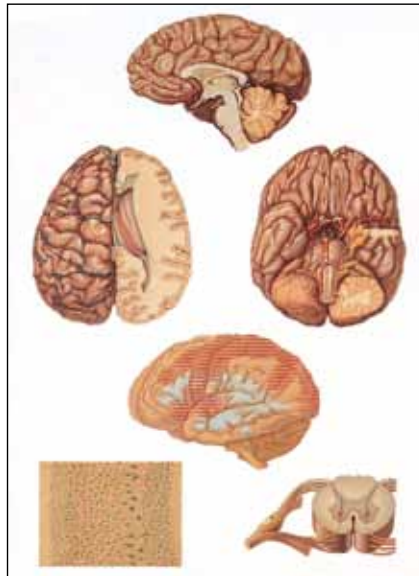

The Human Central Nervous System
9985-4006536 –
9985-1001185 +

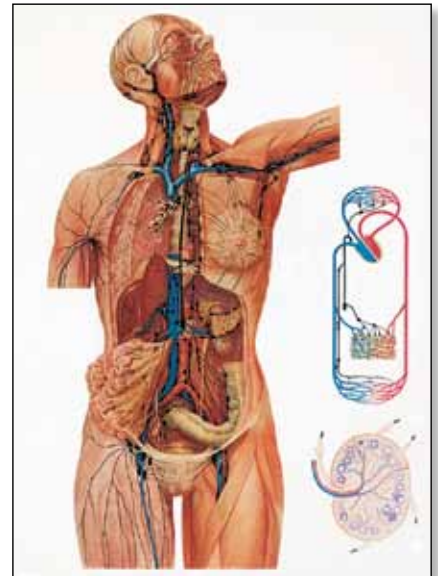

The Lymphatic System
9985-4006553 –
9985-1001216 +



Endocrine Glands
9985-4006545 –
9985-1001200 +

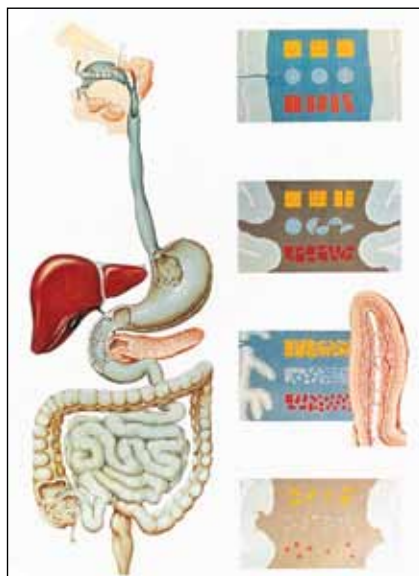

The Digestive System
9985-4006542 –
9985-1001196 +

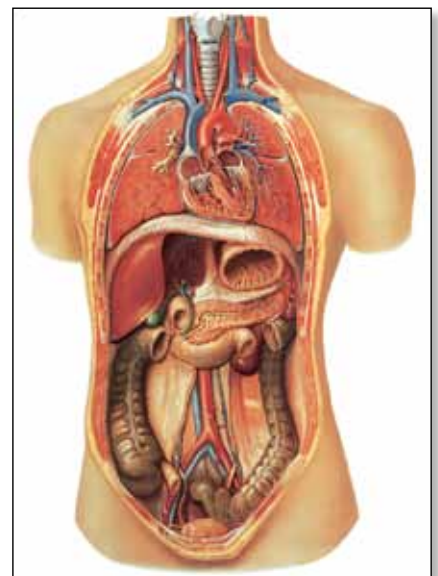

Internal Organs
9985-4006517 –
9985-1001155 +

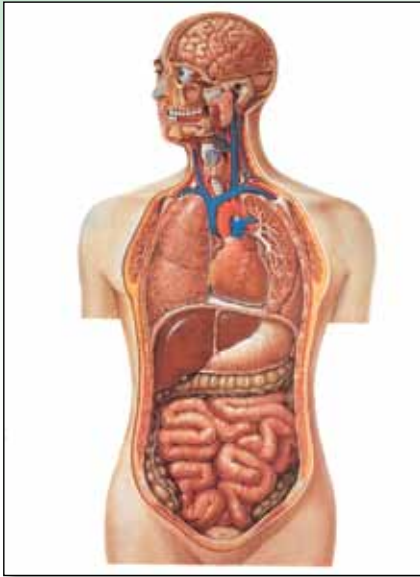

Torso
9985-4006519 –
9985-1001159 +

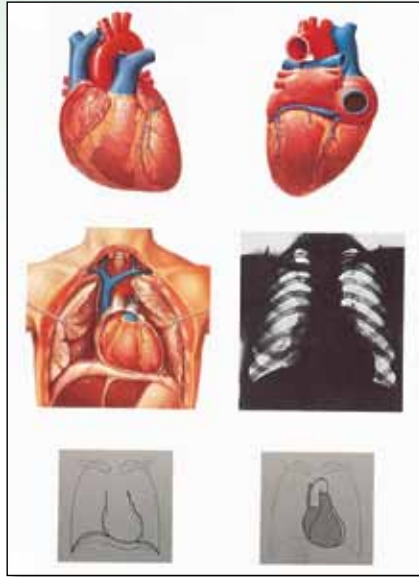

The Heart, Anatomy
9985-4006552 –
9985-1001214 +

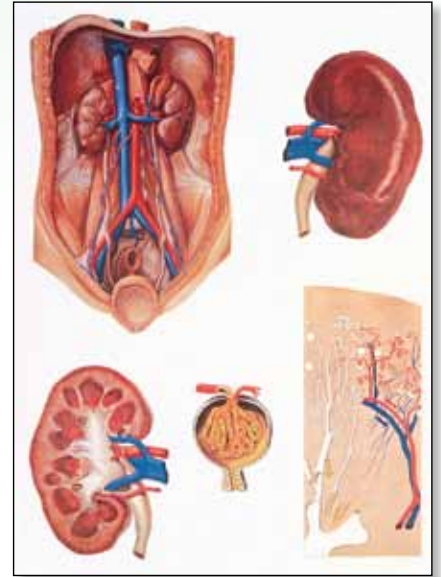

The Kidney
9985-4006523 –
9985-1001165 +

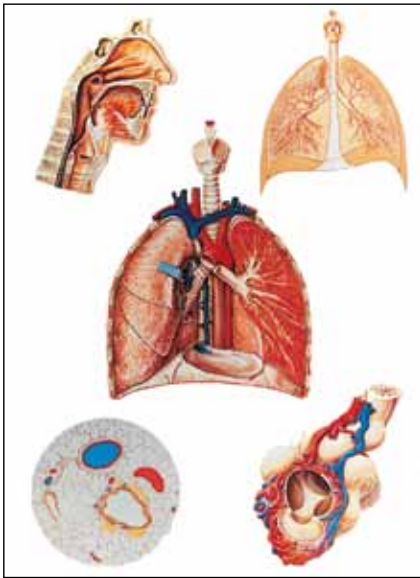

Respiratory Organs
9985-4006538 –
9985-1001188 +

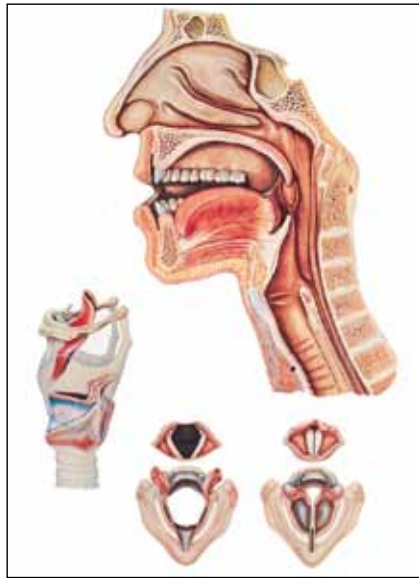

Speech Organs
9985-4006518 –
9985-1001157 +

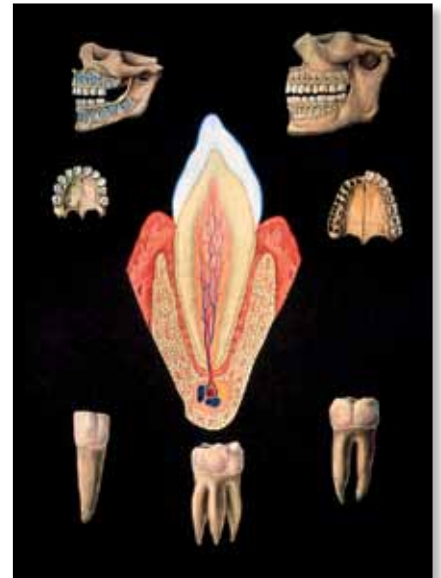

Healthy Denture
9985-4006524 –
9985-1001167 +

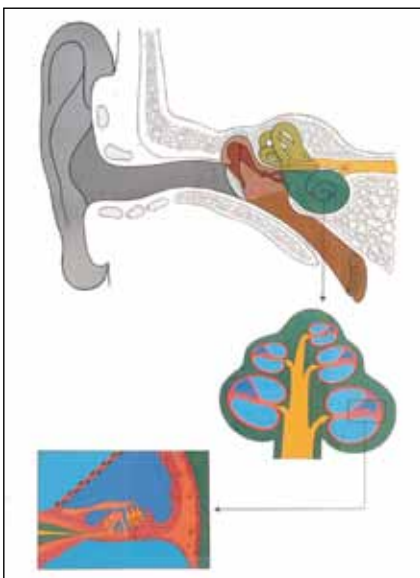

The Ear
9985-4006520 –
9985-1001161 +



The Eye, Anatomy
9985-4006521 –
9985-1001163 +



Bacteria
9985-4006541 –
9985-1001194 +

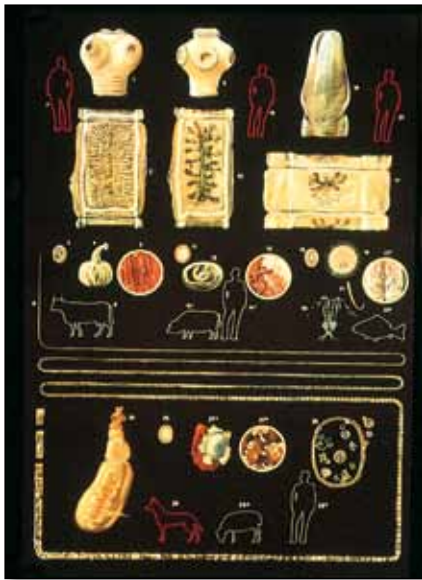

Intestinal Parasites I
9985-4006526 –
9985-1001171 +

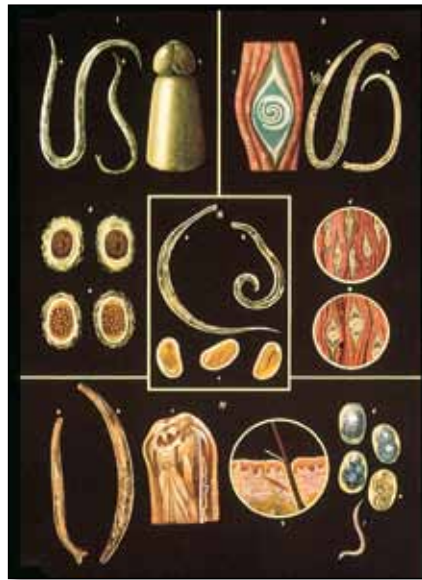

Intestinal Parasites II
9985-4006532 –
9985-1001181 +



9985-1005548

Study and Information System for Self Study

Clear layout, inexpensive, effective. Printed on stable cardboard sized DIN A7. Comes in an index-card box.

The Muscular System on Study Cards

- Each muscle illustrated separately
- Identification of origin, insertion, nerve, function, synergists and antagonists
- 303 study cards with 315 illustrations

“Thin Man” – Sequential Human Anatomy Programme

Lets you explore body regions layer by layer by peeling away transparent mylar overlays. Displayed on the rear of the Thin Man is a full-figure view of the skeletal and nervous systems. Over 200 anatomical features are named, indexed, and keyed. The layers display the following systems:

- 1st layer – Musculature of the head, neck, thorax and abdomen
- 2nd layer – Brain, thyroid and salivary glands, eye, tongue, teeth, heart and major vessels, lungs, stomach, liver and intestines
- 3rd layer – Sinuses, nasal, septum, tongue, trachea, heart, chambers, and vessels, pancreas, spleen, large intestine
- 4th layer – Oesophagus, pleura, aorta, inferior vena cava, intercostal vessels and nerves, autonomic nerve trunk, kidneys and adrenal glands
- 5th layer (full figure) – Brain, pharynx, vertebral column, rib cage, muscles of upper and lower extremities, pelvic organs and muscles

160 cm
E

9985-1005548

German

9985-1003740

English

9985-1003741



9985-1003742
9985-1003743

The Skeletal System on Study Cards

- Each bone illustrated separately (360° view)
- Identification of all bone structures
- 303 study cards with 558 illustrations

German

9985-1003742

English

9985-1003743



9985-1003740
9985-1003741



9985-1005180

Mini Cricotracheotomy Trainer Individual

The main benefit of this trainer is the low running cost. Use of a simple disposable trachea transforms the trainer into a very effective low cost system. 18x16x10.5 cm; 0.56 kg

E

9985-1005184

Mini Cricotracheotomy Trainer 4-Packs

All other features like 9985-1005184.

E

9985-1005185



9985-1005184

The Lifeform® NG Tube & Trach Skills Simulator

The Lifeform® NG Tube & Trach Skills Simulator has been developed to aid with the instruction, training and practice of vital tracheostomy skills and care for patients with respiratory conditions. The simulator is also designed for instruction of gastrointestinal care procedures through nasal and oral access. With a newly designed Lifeform® head and torso, this simulator features realistic landmarks, trachea, oesophagus, lungs and stomach. For exceptional realism, methyl cellulose can be mixed with water to simulate mucous-like fluids of a real patient. Fluid can be added to the lungs and stomach for realistic tracheostomy care and suctioning. The simulator also allows for the practice of the following:

The simulator also allows for the practice of the following:

- Dressing changes and cuff inflation
- NG tube care, including insertion, irrigation, and removal
- Gastric lavage and gavage
- Feeding tube insertion and removal with the ability to practice feeding
- Nasoenteric and oesophageal tube care
- Oropharyngeal and nasopharyngeal care
- ET tube care.

The simulator is designed to use size 6 ET and NG tube. Spraypump lubricant, a packet of methyl cellulose, and instruction manual are included. The simulator does not include tracheostomy or NG tube.

68x41x26 cm; 16.5 kg

E

9985-1006058

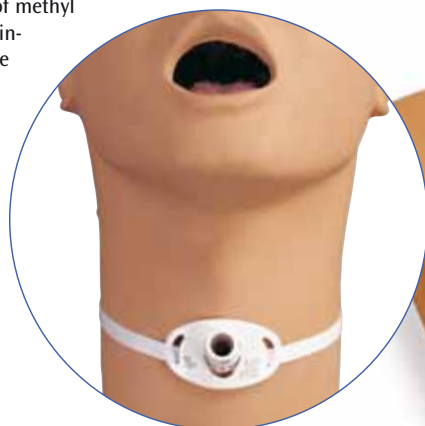

Cricotracheotomy Trainer

For advanced Trauma Life Support courses. An innovative non biological trainer is the Cricotracheotomy Trainer that simulates the laryngeal body tissue. Use of a simple disposable trachea transforms the trainer into a very effective low cost system. Up to 18 Tracheostomies or 36 Cricothyroidostomies can be performed on a single component. Palpable anatomical presence is achieved with comparatively easy identification of the cricothyroid cartilage and the thyroid cartilage. Responsive incision making. Effective alternative to use of animal tissue. Supported in a strong and immovable base. Scalpel is not included in scope of delivery.

45x15x36 cm; 3.0 kg

E

9985-1005180

Replacements for 9985-1005180

Art. No.	Description	Dimensions / Weight
9985-1005181	Trauma Kit (2 Tracheas and 4 Sheets of Skin)	19x15x5 cm; 0.6 kg
9985-1005182	Cricotracheotomy Tracheal Rings	9.5x5x5.5 cm; 0.08 kg
9985-1005183	Cricotracheotomy Neck Muscle	12x8x7 cm; 0.3 kg

Options and replacements for 9985-1006058

Spray Pump Lubricant

25x13x8 cm; 0.28 kg

9985-1005634

Soft Carrying / Storage Case

70x50x33 cm; 2.8 kg

9985-1005773

Adult trach tube

9985-1005696

Methyl Cellulose to Prepare Tracheal Secretions

100ml

9985-1005697

Ren Cleaner

355ml

9985-1005776



9985-1006058

Tracheotomy Care Simulator

This simulator replicates an adult male containing oral and nasal passages and all appropriate anatomy such as pharynx, epiglottis, trachea, oesophagus, stoma, cricoid cartilage, representative cervical vertebrae, left and right bronchi and the bronchial tree. The oesophagus dead ends 5 cm below the tracheal opening. A perfect aid to practice oral, nasopharyngeal, nasotracheal and tracheal suctioning, proper cuff inflation, as well as cleaning of the stoma area and changing dressings or ties. An observation window in the neck allows sight of the suction and trachea tube. From the bottom of the simulator one can visually verify the location of a suction catheter in the right bronchus (seen) or left bronchus (unseen). Tracheotomy tube is not included. Delivered with lubricant and carrying case. 53x28x53 cm; 11.0 kg

E

9985-1005592



9985-1005592

Nasogastric Intubation Model

This instructional model shows a median section through nose, mouth, pharynx, trachea, oesophagus and stomach. Plastic feeding tubes or catheters may be passed through the nose or mouth into the oesophagus and stomach. A tracheostoma has been added to demonstrate endotracheal aspiration.

58.5x30.5x8 cm

E

9985-1005568



9985-1005568

Catheterisation Simulator, Male

This simulator consists of a male abdomen and allows you to feel the pressure and resistance caused by the mucosal folds, bulbous urethra and the internal urethral sphincter, just prior to the entrance into the bladder. When the catheter enters the bladder, artificial urine (water) will flow through the catheter. Proper positioning and movement of the penis during the catheterisation can be easily practiced. Supplied with catheter, lubricant and transport case.

43x25x30.5 cm; 6.0 kg

E

9985-1005587



9985-1005587

Enema Administration Simulator

All aspects of the simulator are lifelike in every detail. The upper buttock is flexible so that the trainee must raise the buttock in order to locate and make insertion into the anus. Portable and easy to keep clean, the simulator features a 1 litre fluid reservoir which is adequate for most demonstration and practice purposes. For large groups, a drainage tube is provided so that the fluid can be drained directly into a large container or sink for continuous use. Includes a hard carrying case and enema administration set.

E

9985-1005626

NEW Page 10



9985-1005626



9985-1005588

Catheterisation Simulator, Female

This simulator consists of a female abdomen and allows you to feel the pressure and resistance when a catheter is passed through the urethra and sphincter into the bladder. When the catheter enters the bladder, artificial urine (water) will flow through the catheter. Realistically molded external genitalia and perineum, labia minora, clitoris, urethral opening and vaginal introitus. Delivered with catheter, lubricant, carrying case. 61x40.5x33 cm; 11.0 kg

E

9985-1005588

Options and Replacements for 9985-1005587 / 9985-1005588

10 Urethral Catheter, CH16

9985-1005612

Lubricant for 3B Simulators, 250 ml

9985-1008575

Options and Replacements for 9985-1005626

Lubricant

9985-1005629

Catheterisation Trainers for Clinical Skills

These fantastic catheterisation trainers have been developed to practice catheterisation on an very realistic model. It does not loose liquid after the training.

- Floppy and soft to touch
- Palpation of the pubic symphysis is clearly identified
- Inserting a suprapubic catheter is quite straight forward and drainage can follow
- The bladder will hold up to 1.5 pints or 800 ml of liquid and the tummy is palpably soft to touch
- Full instructions and an accessory kit with lubricant gel and a bladder syringe are included
- A small amount of gel on the tip of the catheter will enhance the procedure considerably
- Resistance is felt where one would expect and once passed this point flow is easy to achieve

All trainers come equipped with a coated Foley catheter in an appropriate size (16 CH. for the male, 14 CH for the female), lubricant to aid access and a kidney dish. Rubber catheters are preferable to the use of sylastic materials. 43x22x22 cm; 4.9 kg.

E

Male Urethral and Suprapubic Catheterisation Trainer

9985-1005170

Female Urethral and Suprapubic Catheterisation Trainer

9985-1005171



Options and Replacements for 9985-1005170 and 9985-1005171

Art. No.	Description	Dimensions / Weight
9985-1005172	Penis	12.5x12x12 cm; 0.38 kg
9985-1005173	Vulva	12.5x12x12 cm; 0.28 kg
9985-1005174	Suprapubic Skin Pads	20x1.2x1 cm; 0.12 kg

Decubitus Treatment Simulator

This model of a human buttock shows first, second, and third-degree decubitus and allows practice of washing and dressing procedures.

24x37x9 cm

E

9985-1005569



9985-1005569

Decubitus Treatment Simulator

These models of the human sacral region can be fastened on to the body of a student or a training doll like a belt and are made of soft realistic material. The set consists of 4 different "belts" and represent the following stages of decubitus in an extremely realistic fashion:

- Stage I: The epidermis has not yet been torn but redness can be observed
- Stage II: Abrasion, bleeding and effusion can be observed
- Stage III: Healing process of stage IV where the fascia and musculature have been affected
- Stage IV: Decubitus ulcer with visible tissue structures down to the bone.

E/J

9985-1012347



9985-1012347

Seymour II™ Decubitus Treatment Simulator

Redesigned and now made with a new flexible, life like material that permits the application and easy removal of dressings, without leaving an adhesive residue. Still the most comprehensive model of its kind, molded from a 74-year-old patient, looks and feels like the real thing. Displaying the following pressure ulcers* (NPUAP 2007 – National Pressure Ulcer Advisory Panel): Stage I, Stage II, Stage III with undermining, tunneling, subcutaneous fat and slough, deep Stage IV with exposed bones, undermining, tunneling, subcutaneous fat, eschar and slough. Also shown are a suspected DTI (Deep Tissue Injury), unstageable full eschar/slough wound, and a dehisced wound. The Stage III and Stage IV are positioned so that a "bridging" dressing for use with a vacuum assisted closure and negative pressure wound therapy devices can be demonstrated and practiced. This model makes it possible to visualize and understand the differences in wounds. Great care has been taken to colour each wound just as you would see it on a patient. You are able to demonstrate and practise wound cleansing, classification, staging, and assessment, as well as the measurement of wound length, depth, undermining, and tunneling. The positioning of the wounds permits multiple dressings to be demonstrated at the same time.

E

9985-1009798

NEW Page 10



9985-1009798

Options and Replacements for 9985-1009798

Carrying Bag
With side compartment for dressing material.

9985-1005832

9985-4006720 *
9985-1001606 **

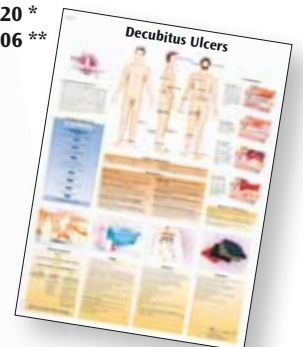

You will find our large selection of Charts starting on page 108.

Stoma Care Training Model I with Case

You can feel really the texture of the skin! This adhesive Stoma Care Training Model fits accurately on a patient's stomach, making it possible for both nurse and patient to practise stoma care.

Features of the product:

- Using this model, you can practice stoma care and self care training. You can also use it for educational purposes. For clinical care, this will give patients pre-operation information on how to care for their own stoma.
- The simulated skin is made of special silicone, the touch and appearance of which is quite similar to human abdomen skin.
- The stoma is made of silicon and has a hole in the middle where you can practice the injection and excretion of simulated stools (Simulated Stool (9985-1006051) is available but not included).
- This model sticks comfortably on your skin.
- When it gets dirty or the stickiness becomes ineffective, wash with water and let it dry. This model may be used repeatedly.

Size: 176x245x5 mm
 Weight: 210 g
 Stoma size: 30 dia.x20 mm

9985-1006049

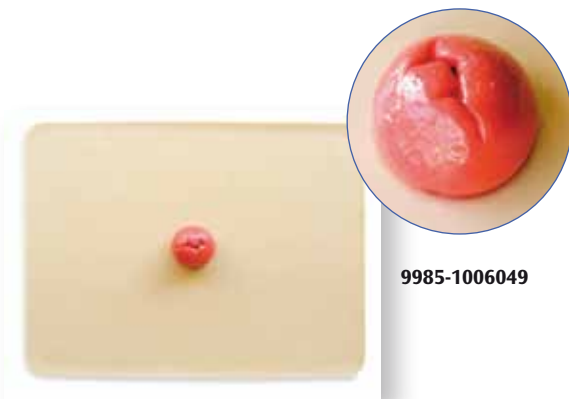

9985-1006049

Ostomy Care Model

This model contains four stomas that can be lubricated and dilated with an inserted finger. Model may be washed, taped, bandaged or fitted with ostomy bags. Supplied with lubricant.

33x46 cm

E

9985-1005570

Male & Female Catheterisation & Ostomy Care Simulator

- Catheterisation: The interchangeable male and female genital organs feature a modular urethral valve to prevent fluid leakage.
- Ostomy care: 3 stomas (transverse colostomy, ileostomy, suprapubic) may be dilated and allow practice of irrigation procedures as well as application of ostomy bags. Each stoma is connected to an internal tank.

Supplied with carrying bag.

50.8x45.7x33 cm; 8.0 kg

E

9985-1005806

Ostomy Care Simulator

Reproduction of an abdomen showing the anatomy of both a colostomy and ileostomy to provide lifelike functions and appearance. Dilation of the stomas can be demonstrated and practiced, along with application of post-operative and permanent ostomy bags. The colostomy can be irrigated. Drainage and excretion at the ileostomy (water) and colostomy (simulated stool) can be pumped by syringes. Delivered with simulated stool and carrying case.

45.5x45.5x30.5 cm; 11.0 kg

E

9985-1005591

Stoma Care Training Model II with Case and Simulated Stool

It's flexible! Easy to wear over your clothing! This model can be put over your clothing with the attached belt. It's great for people who are hesitant to show their stomach in public.

- The hole in the middle will enable you to practice injection for the simulated stool.
- The belt is removeable, allowing placement of the unit directly on the stomach just like 9985-1006049 Stoma Care Training Model I.

Main Unit Size: 145x205x10 mm (Stoma's thickness is 20 mm.)
 Weight: 220 g
 Belt Size: 30x1080 mm

9985-1006050



9985-1006050

Options and Replacements for 9985-1006049 and 9985-1006050

Simulated Stool with Dispenser

Weight: 50 g

9985-1006051

Options and Replacements for 9985-1005591

Simulated Stool

9985-1005615



9985-1006051



9985-1005570



9985-1005806

NEW Page 10



9985-1005591



Skin Suture Trainer

A great low cost way to practice surgical opening and closing techniques.

Features:

- Economical reversible pad
- The material has been designed to make complex incisions such as “flap and dog turn” suturing more realistic
- A sub-dermal layer is present so that it is possible to make secure intra-dermal sutures
- Base has suction feet to make it slip free use

11x14 cm

E

9985-1005134

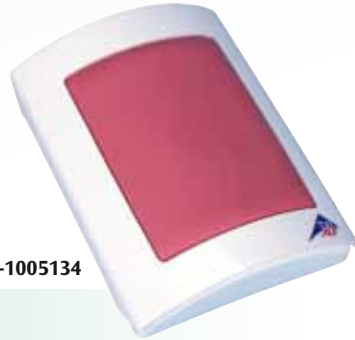

9985-1005134

Options and Replacements for 9985-1005134

Double Sided Skin Suture Pad

9985-1005133



9985-1005133

Episiotomy Suturing Simulator, Set of 3

This simulator provides a realistic way for students to learn surgical techniques without the constraint of time and concern for safety, which are factors with a live patient. In addition to being portable, the lifelike texture allows the learner to develop a “feel” for instrument handling, tension on suture and the advantages of one method of tying knots over another. The set includes midline, left mediolateral and right mediolateral episiotomies and is supplied in a storage case. Needle holder, suture material and tweezers are not included in scope of delivery.

20x15x7 cm; 1.5 kg

E

9985-1005627



9985-1005627

Suture Practice Arm

This arm is made of a soft vinyl skin over foam allowing hundreds of suture practice sessions. The arm comes with 3 wounds, as well as several cuts which can be placed all over the arm, hand and fingers and sutured several times. The soft and pliable material guarantees the sutures will not pull out when tightened. Delivered with a starter suturing kit. Like 9985-1005683. 62x18x13 cm; ca. 1.0 kg

E

9985-1005585

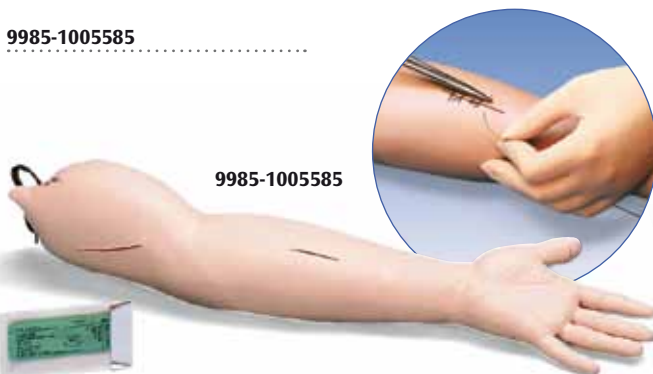

9985-1005585

Surgery Trainer

The Surgery Trainer allows open surgery practice and offers an advanced skills capability for cut and suture practice. The single sided skin pad and a piece of abdominal bowel (which can be anastomosed) are replaceable.

- Highly portable
- Rubber suction feet secure the base providing easy working conditions
- Washable, durable and all parts are replaceable

Sutures and string not provided. 25x23x9 cm

E

9985-1005144



9985-1005147

9985-1005144

Options and Replacements for 9985-1005144

Art. No.	Description
9985-1005145	Single Sided Skin Pad, 6x9 cm
9985-1005146	Two Layered Abdominal Bowel, 2x9 cm
9985-1005149	Two Layered Abdominal Bowel, 3x27 cm

Suture Practice Leg

Made with a soft vinyl skin over a core of stitchable foam to provide a life-like suturing experience for students or a realistic suturing demonstration by an instructor. Realistic skin texture with wrinkles and pores. Soft and pliable for easy sewing, the skin is tough enough that sutures will not pull out when tightened. Each unit provides three “wounds”. These “wounds” can be sutured repeatedly until the skin around them is finally worn out; then, new “wounds” can be cut. Although disposable, the trainers provides hundreds of suturing experiences before wearing out. Conservatively, over one hundred cuts can be made on the trainer and each of these cuts can be sutured several times. Suture Practice Leg is complete with a starter suturing kit and instruction booklet.

2.0 kg

E

9985-1005683



9985-1005683

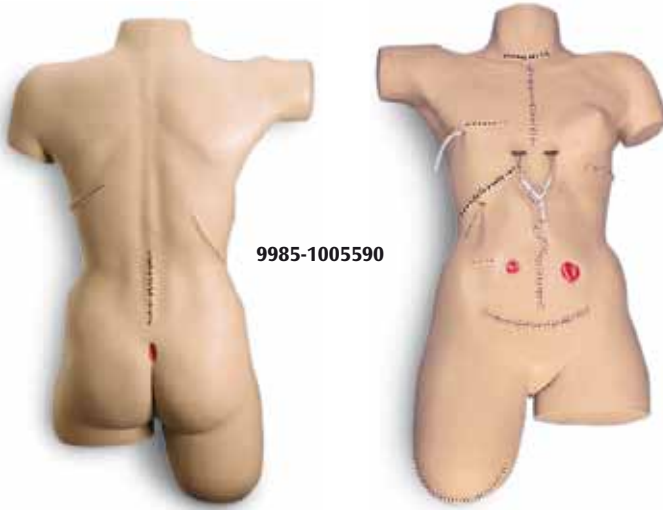

9985-1005590

Bandaging Simulator

This simulator consists of a female torso with flexible, lifelike skin which realistically responds to adhesives and all types of bandaging procedures. 14 different wounds allow one to practice wound management techniques, cleaning and bandaging techniques just like on a real patient. Wound closures feature surgical staples and sutures which cannot be removed. The simulator is supplied in a carrying case and features the following wounds: Thyroidectomy, mid-sternal split with chest tube drains (surgical staples), mastectomy with simulated drain, cholecystectomy with simulated T-tube, laparotomy (surgical staples), appendectomy, colostomy, ileostomy, abdominal hysterectomy (surgical staples), thoractomy (surgical staples), nephrectomy (surgical staples), laminectomy, sacral decubitus ulcer (stage II), leg amputation stump (surgical staples)

84x30.5x63.5 cm; 12.0 kg

E

9985-1005590

Auscultation Trainer and SmartScope™

This simulator allows training of the auscultation of various heart and lung sounds as in a real patient. The instructor can select various conditions by a wireless remote control. When the student has identified the correct auscultation sites by palpating, the heart and lung sounds can be heard by using a special Stethoscope (SmartScope™). The simulator has 6 heart sites and 2 lung sites on the anterior and 16 lung sites on the posterior. One remote control can operate multiple sets of SmartScopes™ (see 9985-1005643) and manikins (see 9985-1005644) simultaneously so that this simulator is also great for group instruction. Remote control works over a range of up to 30 meters. The simulator is supplied in a storage case and comes with one remote control and one SmartScope™ with single and dual user headpieces. Operates using two "AA" and two "AAA" batteries (included). The following sounds can be auscultated:

Heart sounds:

1. Normal
2. Aortic regurgitation
3. Pulmonary stenosis
4. Mitral stenosis
5. Holosystolic
6. Mid-systolic
7. S3 Gallop
8. S4 Gallop
9. Systolic click
10. Atrial septal defect
11. PDA
12. VSD

Lung sounds:

1. Normal tracheal
2. Normal vesicular
3. Wheezes
4. Mono wheeze
5. Fine crackle
6. Coarse crackle
7. Ronchi crackle
8. Stridor
9. Cavernous
10. Bronchovesicular
11. Bronchial
12. Pulmonary edema
13. Infant
14. Friction rub
15. Egophony
16. Pectoriloquy

E/D/S/F/I

9985-1005642

Lower Stump Bandaging Simulator

Most standard bandaging procedures can be practiced or demonstrated. The lower torso is long enough to allow the bandage to be wrapped around the body over the involuntarily hip at the level of the iliac crest. (Note: There is no embedded, palpable skeletal material.) Can be used to demonstrate the attachment of prosthetic devices. The lower torso is representative of a prone patient with legs slightly abducted. One leg is amputated below the knee; the other mid-thigh. Includes an instruction booklet.

Individually boxed.
89x38x25.4 cm; 6.0 kg

E

9985-1005681

Upper Stump Bandaging Simulator

Most standard bandaging procedures can be practiced or demonstrated. Can be used to demonstrate the attachment of prosthetic devices. The upper torso includes the two arms – one is amputated above the elbow; the other above the wrist. Both arms are slightly extended in a "patient-like" position to facilitate bandaging. The compressibility of the material very closely duplicates actual experience with a patient. Includes an instruction booklet. Individually boxed.

66x45.7x33 cm; 7.0 kg

E

9985-1005680



9985-1005681

9985-1005680

Set of 2 Stump Bandaging Simulators (not shown)

Includes: lower torso, upper torso, instruction booklet. Individually boxed.
89x38x25.4 cm; 11.0 kg

9985-1005682

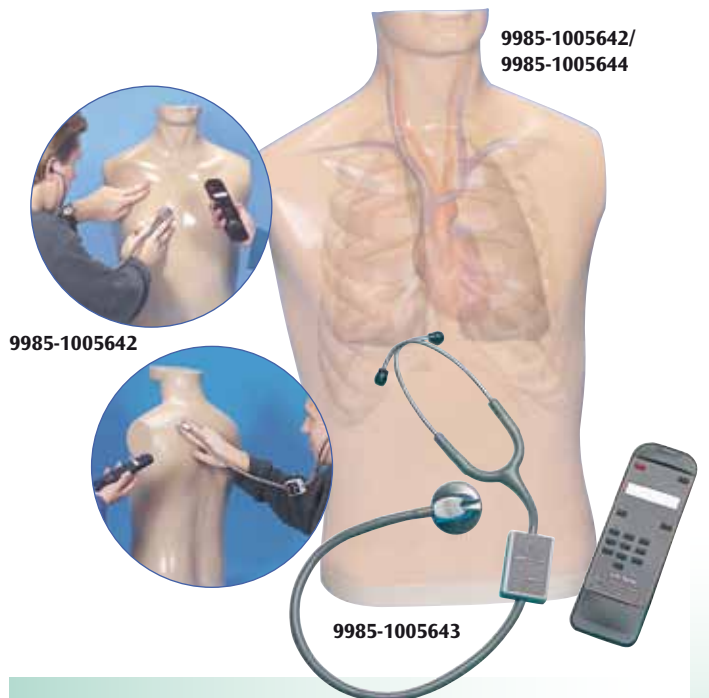

9985-1005642/
9985-1005644

9985-1005642

9985-1005643

Options and Replacements
for 9985-1005642
SmartScope™

9985-1005643

Auscultation Trainer
(Body only)

9985-1005644



9985-1005884

Heart & Breath Sounds Simulator

This hand held device simulates both heart and breath sounds and allows the determination of these by plugging in one of 6 different menus (see 9985-1005885, 9985-1005886, 9985-1005887, 9985-1005888, 9985-1005889 and 9985-1005890), each containing 16 different sounds. The Heart and Breath Sounds Simulator unit includes two external sounders with which students can auscultate the sounds with a stethoscope. Linking additional sounders (see 9985-1005892), up to 15 students can auscultate at the same time. A Loud Speaker may also be connected. Additionally, the unit has a volume control and two LED's that illuminate during systole (heart menu) and expiration (breath menu). Virtually maintenance free, the unit is powered by a 9 volt battery.

E

9985-1005884

Stainless Steel Twin-Head Stethoscope

Excellent hold on skin – optimal sound transmission in the high-frequency range (100 – 1000Hz)– balanced outcomes in low-frequency areas (20 – 100Hz)

Some features of this carefully-worked stethoscope

- A high-precision twin-head chest piece in stainless-steel design
- An ultra-sensitive membrane in the stethoscope head
- Carefully-processed and polished ear clip with an extra-wide diameter
- The PVC rings suppress the cooling effect, bringing increased patient comfort

Greater comfort of application - exactly tuned results in auscultation.

Scope of delivery: A stethoscope with two replacement ear tips, 1 ultra-sensitive membrane, 1 bracket for a name plate
33x16x5 cm

9985-1012901



9985-1012901

Options for 9985-1005884

Stethoscope Sounders

9985-1005892

Paediatric Heart

9985-1005889

Basic Heart Sounds

9985-1005885

Infant Heart & Breath Sound

9985-1005890

Basic Murmurs

9985-1005886

Breath Sounds

9985-1005887

9985-1005887

Paediatric Breath & Heart

9985-1005888



For detailed information about the menus please go to www.3bscientific.com

Blood Pressure Simulator Arm with PDA

PDA technology brings you the latest training device for teaching blood pressure skills. Our battery operated blood pressure trainer can also be plugged into any 110V but not 220V AC and comes with the adapter and jack. The PDA is also included, along with the programming and a BP cuff to allow for realistic blood pressure training. This PDA blood pressure training arm features:

- Sphygmomanometer placement
- Palpation of the radial pulse
- Variable systolic a diastolic pressures from 0-300 mm Hg in two mm-increments, variable amplitude of sound heard at the antecubital site
- Sound jack for group listening
- Auscultatory gap setting
- Heart rate settings

This is a great PDA blood pressure arm!

E

9985-1005775



9985-1005775

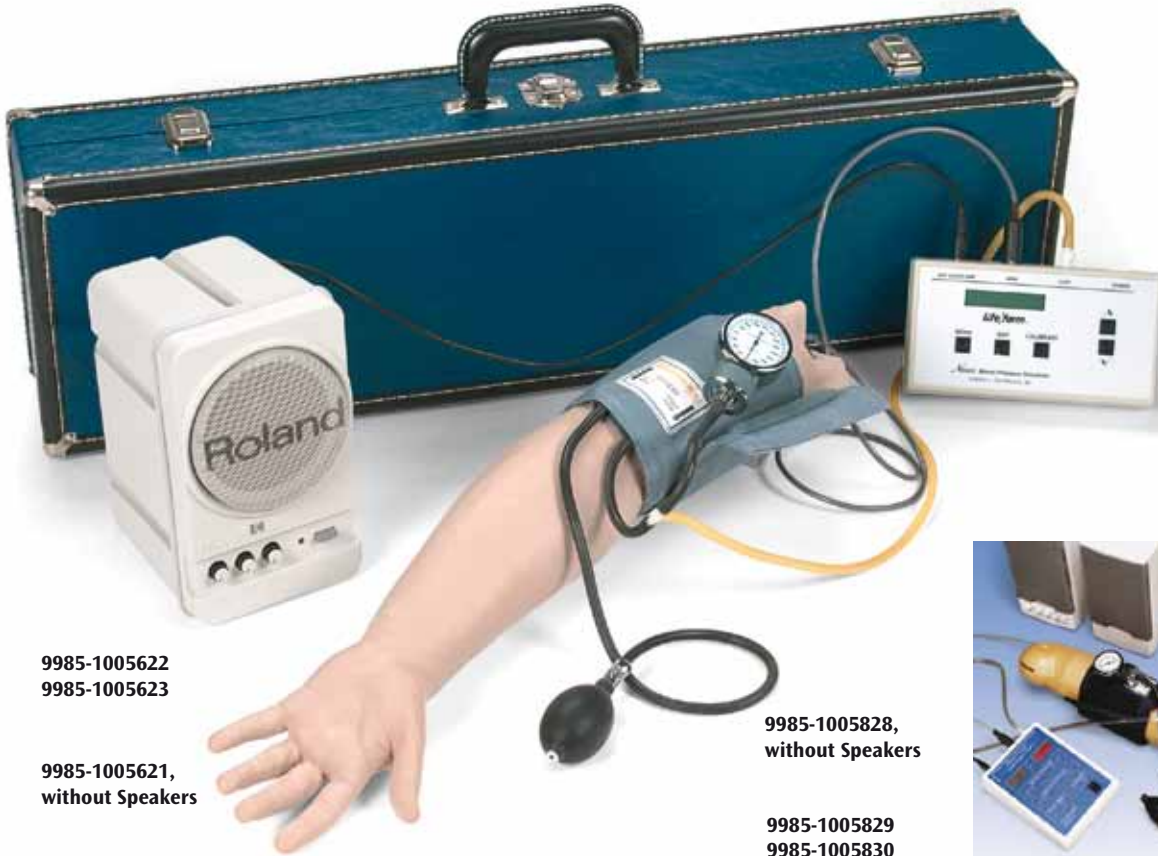

9985-1005622
9985-1005623

9985-1005621,
without Speakers

9985-1005828,
without Speakers

9985-1005829
9985-1005830



Blood Pressure Arm with External Speaker System, 115/230 V

This arm features an embedded speaker plus an electronic control unit. It allows the instructor to preset any combination of systolic and diastolic pressures and to control the pulse rate and volume level. An auscultatory gap can also be added and the five Korotkoff phases can be audibly discerned. The pressures are activated at release valve by the student and can be read directly from the sphygmomanometer. When using the Blood Pressure Simulator, students are never “approximately” correct – with the preset values they are either right or wrong. The external speaker system allows an entire classroom to auscultate blood pressure sounds, which normally can be heard only by one person via stethoscope. The electronic control unit also features a manual calibration button that allows the unit to be used with any type of sphygmomanometer. The simulator is supplied with the external speaker, the electronic control unit (4 “AA” batteries included), a sphygmomanometer and a hard carrying case. A stethoscope is not included.

80x26x32 cm; 5.0 kg

E

9985-1005622

9985-1005623

Blood Pressure Arm

Same as 9985-1005622/-23, but without speakers.

E

9985-1005621

Blood Pressure Training Arm

This left arm connects to adult Patient Care Manikins (if given as an option). Systolic and diastolic pressures, auscultation gap and pulse rate are adjustable. The cuff pressure can be seen on a display.

Features include:

- Palpable radial pulse when cuff pressure is less than the selected systolic blood pressure
- Korotkoff sounds K1 to K4 (K5 is silence) are audible in the antecubital area between systolic and diastolic pressures
- Korotkoff sounds are automatically silenced if auscultation gap is selected
- Korotkoff sounds are automatically adjusted depending upon selected heart rate and rate of cuff deflation
- International power supply 100 to 240 V

Supplied with stethoscope, sphygmomanometer cuff with tubing assembly and carrying bag, without speakers.

89x38x23 cm; 4.5 kg

E

9985-1005828

Blood Pressure Training Arm with Speakers, 110 V

A speaker system with volume control makes the stethoscope sounds audible for large groups. All other features as 9985-1005828.

9985-1005829

Blood Pressure Training Arm with Speakers, 220 V

A speaker system with volume control makes the stethoscope sounds audible for large groups. All other features as 9985-1005828.

9985-1005830



9985-1000342

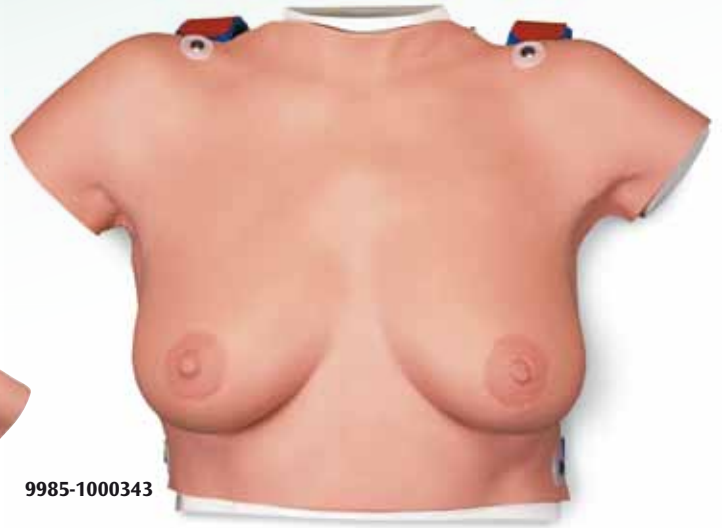

9985-1000343

Wearable Breast Self Examination Model

Same features as 9985-1000342, supplied without "Female Breast" chart and transport case.

51x37x15 cm; 6.3 kg

E/D/S/F/P/J [www.](#)

9985-1000343

Breast Examination

Wearable Breast Self Examination Model

Demonstrate realistic self examination with our natural casting of a female upper body with medium sized breasts. It can easily be worn, in order to better train and practice breast self examination.

- Made of new 3B SKINlike™ high quality silicone
- Displays the skin in finest detail
- Very realistic to the touch and dermatologically tested
- Breast examination is possible in both upright or lying positions
- Benign and malignant tumours in different stages of development hone self-examination skills
 - 2 benign tumours
 - 4 malignant tumours
 - 2 typical anomalies
- Includes "Female Breast" chart
- Supplied with talcum powder, harness, stand and aluminium carrying case

56x44x24 cm; 11.5 kg

E/D/S/F/P/J [www.](#)

9985-1000342



9985-1000344

Breast Self Examination Model, Three Single Breasts on Base

Very realistic natural casting of three different female breasts in C and D cups, to train and practice breast examination.

- Made of new 3B SKINlike™ high quality silicone
- Displays the skin in finest detail
- Very realistic to the touch and dermatologically tested
- Benign and malignant tumours in different stages of development are featured in two breasts
- A healthy breast is supplied for comparison
- Supplied with base and talcum powder

52x24.5x9.5 cm; 2.3 kg

E/D/S/F/P/J [www.](#)

9985-1000344



9985-1005159



9985-1005159

Clinical Breast Trainer

This Trainer combines modularity and practicality for clinical skills in diagnosis and palpation.

- Five identifiable anatomical anomalies.
- Fluid filled cyst for aspiration and palpation
- 2 palpable lumps (approx. 1 cm and 1.5cm diameter) on the lateral side of the breast
- Infection in armpit in axilla region
- Lump in tissue above the clavicle
- Modular design for simple replacement of skin, cyst, lump axillary gland
- Skin detaches for replacing cysts
- Realistic tactile feel
- Easy to keep clean

22x25x14 cm; 2.0 kg

E

9985-1005159

Options and Replacements for 9985-1005159

3 Fluid-filled Cysts

9985-1005160

Lumpy Axillary Gland

9985-1005162

Outer Breast Skin

9985-1005161

Medical Techniques



9985-1000346



Testicle Model

This life size testicle model offers an extremely natural feel. By using SKINlike™ (dermatologically tested), 3B's high quality silicone, learning and practicing self examinations of the testicles becomes even more realistic. The scrotum contains two movable testes, the epididymi and the spermatic cords for palpation. Two pathological findings can be felt in the left testicle. The front of the model also includes a replica of the base of the penis. Supplied with detailed instructions for self examination and a carrying bag.

9x8x4 cm; 0.19 kg

E/D/S/F/P/J

9985-1000346

Testicle Self Examination Model

Providing exceptional realism, this simulator features soft, thin outer skin with delicate underlying structures and four embedded, simulated tumours. Ideal for teaching proper palpation techniques.

23.5x16x6.5 cm; 0.475 kg

E

9985-1005640



9985-1005640

Lumps and Bumps Box

A simple and very effective tactile trainer has been developed to make a Lumps and Bumps Box. The trainer is ideal for juniors getting to grips with their sense of touch and to understand the basic art of description about the feeling through gentle palpation.

- The trainer can be lap held
- Placed on a smooth surface where strong sucker feet provide stability while in use
- Contains 2 skins and 2 layers of foam, an assortment of shapes compatible with modern teaching for Clinical Skills Centres
- Can be varied and customised to suit individual needs

E

27x24.5x10 cm; 1.0 kg

9985-1005164



9985-1005164

Options and Replacements for 9985-1005164

Kit containing a set of 2 skins, 2 layers of foam and an assortment of shapes

27x24.5x10 cm; 0.8 kg

9985-1005165

Lumps

20x1.2x1 cm; 0.08 kg

9985-1005166



9985-1005594

Prostate Examination Simulator

This simulator consists of a male abdomen body and 4 different interchangeable prostate glands which can be inserted to allow realistic practice in diagnosis by rectal examination. Supplied with lubricant, cleaner and transport case. The 4 prostate glands represent the following characteristics:

- Benign, slightly enlarged, but otherwise normal
- Beginning stage of carcinoma, a discrete, hard nodule is palpable in the upper right quadrant
- The spread of carcinoma is demonstrated, the small nodule has increased in size and has become an external hard mass on the surface of the gland
- Totally replaced with carcinoma, the entire gland feels hard and irregular

54.5x38x30.5 cm; 11.0 kg

E

9985-1005594

Options and Replacements for 9985-1005594

Lubricant for 3B Simulators,
250 ml

9985-1008575



9985-1005593

Sigmoidoscopic Examination Simulator

An accurately modelled large intestine with sigmoid colon, splenic flexure, hepatic flexure and the internal structures of the ascending colon and caecum. 12 different pathological structures such as

- Benign sessile polyp
- Pedunculated polyp
- Hyperplastic polyp
- Cancerous lesions can be diagnosed. All manipulation and photographic techniques can also be practiced. Delivered on baseboard and comes with lubricant and transport case.

47x17x66 cm; 9.5 kg

E

9985-1005593



9985-1005163

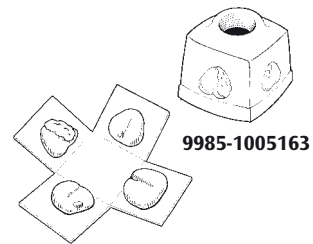

9985-1005163

Prostate Examination Trainer

The trainer is supplied as a four sided box housing 4 prostates: Normal Benign, Enlarged Benign, Early Malignant, Advanced Malignant.

- Realistic tactile sensation
- No prostates need to be replaced
- Each is identified via an access port, using a gloved finger
- Easy to handle

The soft but firm touch of these prostates has been extensively tried and tested by specialist urologists.

E

9985-1005163



9985-1005645

Ear Examination Simulator

This simulator allows practice in the examination of the ear. It consists of a head with 6 interchangeable flexible ears with lifelike external and internal structures. Embedded coloured prints in 5 out of the 6 ears allow the diagnosis of various pathologies. One ear is not coloured, but can be used for earwax removal exercises. The simulator is supplied with 2 tubes of synthetic earwax, nine 35mm slides (5 conditions as below plus 4 conditions as in supplementary set 9985-1005646) and a carry case. An Otoscope is not included. The following normal conditions and pathologies can be observed:

- Normal tympanic membrane
- Mucoïd otitis media
- Serous otitis media with fluid level
- Chronic otitis media with perforation
- Normal tympanic membrane with slanted ear canal

38x38x26 cm; 7.7 kg

9985-1005645

Options and Replacements for 9985-1005645

Supplementary Ears

This set includes 4 ears which allow observation of the following pathologies:

- Chronic otitis media with large perforation
- Attic cholesteatoma (A)
- Attic cholesteatoma (B)
- Atelectatic middle ear otitis and tympanosclerosis

19.5x16x4.5 cm; 0.3 kg

Earwax

9985-1005641

Halogen Bulbs for 9985-1003653

2.5 V, 6 pieces

9985-1003655

Halogen Bulbs for 9985-1003654

2.5 V, 6 pieces

9985-1003656



9985-1003653

Pocket Otoscope

Compact, light-weight and strong otoscope with battery handle (2 x 1.5 V) and halogen lamp (see article 9985-1003655). Supplied with 4 reusable bells (2.4 – 5 mm) as well as 8 disposable bells. 20.5x7.8x2.8 cm; ,0.136 kg

9985-1003653



9985-1003654

ENT diagnostic set

The set is complete with a BETA 100 diagnostic otoscope and 1 set of reusable bells, 10 disposable bells and replacement lamp, in a hard shell case.

9985-1003654



9985-1005241

9985-1005240

Infant Arterial Training Arm

Lifelike reproduction of an infant arm allows students to master infant radial artery puncture techniques. Includes percutaneous puncture sites in brachial and radial artery. Manual radial artery pulse generator provides realistic arterial pressure. Simulated blood may be infused for backflow in syringe.

1.4 kg

9985-1005241

9985-1005241

Infant IO Leg

Lifelike reproduction of infant leg allows students to master infant intraosseous infusion techniques. Simulated tibia and anatomical landmarks at the tibial tuberosity and medial malleolus. Fluid may be infused for realistic flashback. Drain in heel connects to reservoir bag.

1.4 kg

9985-1005240

9985-1005240

Arterial Stick Exercises and Injection Arm, 115/230 V

This right arm combines all features required for arterial stick exercises, i.v., i.m. and subcutaneous injection and infusion training as well as blood collection exercises:

- Arterial stick exercises: Arterial pulses are automatically generated at the radial and brachial locations with a peristaltic pump. AV anastomosis for simulation of haemodialysis
- I.v. injection in venous network of arm and hand. A pressure bulb allows to increase or decrease venous pressure
- I.m. injection in deltoid area
- Subcutaneous injection areas on the volar side of the forearm and the lateral side of the arm
- Incisions and suturing exercises can be practiced on a special pad. Supplied with artificial blood, blood dispensing bag, funnel, talcum powder, replacement skin, base and carrying bag.

E

9985-1005810

9985-1005811



Baby "Arti"

Lifelike reproduction of an infant arm with bony structures allows students to master the technique of neonatal radial artery puncture. Percutaneous puncture site in radial artery. Mechanical radial artery pulse generator provides realistic arterial pressure. Simulated blood may be infused for blood backflow in syringe. Replaceable skin and artery ensures longevity of model. Mounted on a base.

2.7 kg

E

9985-1005236

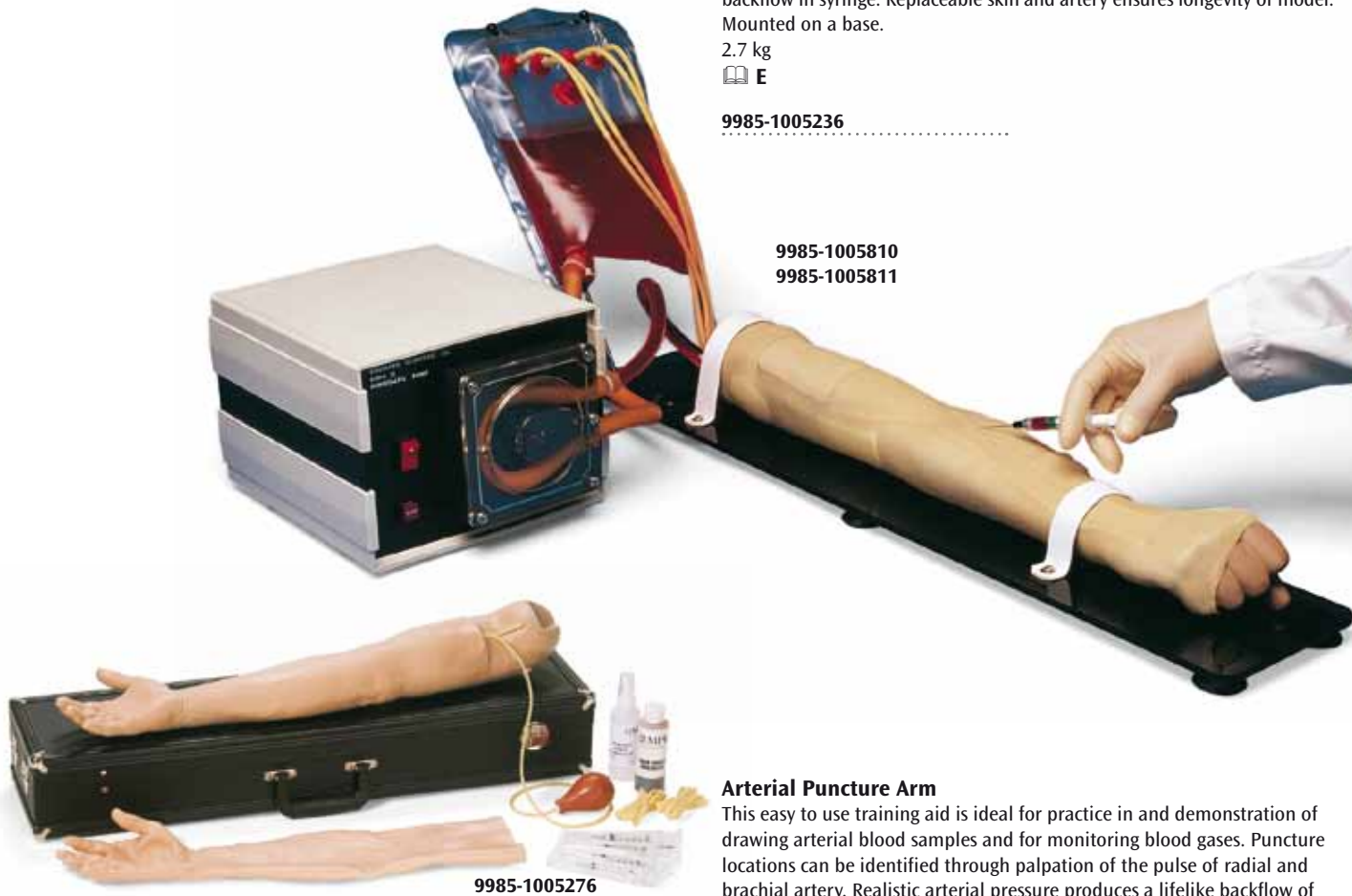

9985-1005810

9985-1005811



9985-1005276

Arterial Stick Arm

Infusible arteries designed for training the proper arterial puncture procedure for blood gas analysis

E

9985-1005276

Arterial Puncture Arm

This easy to use training aid is ideal for practice in and demonstration of drawing arterial blood samples and for monitoring blood gases. Puncture locations can be identified through palpation of the pulse of radial and brachial artery. Realistic arterial pressure produces a lifelike backflow of blood in the syringe, confirming proper needle location in the artery. Delivered with 3 syringes and tubules, artificial arterial blood, 2 replacement arterial sections and carrying case.

71x13x33 cm; 7.3 kg

E

9985-1005598



9985-1005598

Options and Replacements for 9985-1005598

Skin with 3 Artery Sections

9985-1005605



9985-1009800



9985-1009799

NEW

Infant Venous Access Simulator

Now 100% latex-free with redesigned umbilicus and umbilical valve. A unique, anatomically correct representation of a 1,8 kg and 40,6 cm female baby developed to teach and practice the vascular accessing of newborns and infants. There are barely discernable blue veins under the replaceable translucent “skins” on the head, right and left arms and the right leg. Veins are now made with latex-free Dermalike™ with 50% less needle drag when accessing and improved tear resistance to permit a greater number of needle “sticks”. The veins presented include the temporal, external jugular, post-auricular, basilic, cephalic, saphenous and popliteal. When accessing a “pop” is felt as the needle enters the vein followed by a realistic flashback of simulated blood confirming proper needle placement. The veins were specifically designed to have a small internal diameter, as you would find on a small baby. You can practice accessing, securing, dressing, site care, and maintenance for standard IVs and PICC (Peripherally Inserted Central Catheter). A redesigned umbilicus and umbilical valve allows repeated catheterization with a 5FR umbilical catheter with proper placement verified by a blood return. Nasal and oral openings allow placement of nasal cannulas, as well as endotracheal, nasogastric, and feeding tubes to teach suctioning, securing, dressing, cleansing, and maintenance.

9985-1009799

Options and Replacements For 9985-1009799

Skin and Veins

Arm Skin (right and left), Leg Skin (left), Scalp, Veins

9985-1005834

Vein Set with Umbilical Valve

New vein set with umbilical valve attached – Latex Free.

9985-1009800

Artificial Blood, 4.5 Litres

9985-1005837

Paediatric Head

An invaluable tool for demonstrating and practicing infusions and injections in the temporal and jugular veins of a newborn to a twelve month old infant. The neck is made of soft, flexible foam to provide a realistic feel of palpation and puncture. The paediatric head includes the following:

- Head (to represent a six month old infant) with skin and veins
- Fluid supply bag
- 2 different gauge winged infusion needles
- Artificial blood
- Hard carrying case, without stethoscope

45x23x12 cm; 3.8 kg

9985-1005630

9985-1005238



Baby “Ivy”

Simulated infant head with internally molded scalp veins designed for practicing neonatal peripheral venous access of the scalp veins. Peripheral IV line insertion and removal for fluid and medication administration after patient stabilization. Infusible veins allow realistic flash to confirm proper placement. Practice maintenance and securing of line. Mounted on a hard-side case.

1.4 kg

E

9985-1005238

9985-1005630



Options and Replacements for 9985-1005630

Skin and Veins

9985-1005631

Veins

9985-1005632

NEW



9985-1008937

IV Torso

The IV Torso allows practicing of intravenous access techniques. The IV Torso has been specifically designed to meet the key educational goals of training programs.

Product benefits:

- Enables students to experience realistic procedures
- Areas for IV access are simulated by soft pads. These are covered by a realistic skin, which simulates the feel of human skin as closely as possible
- The simulated veins inside the pads provide a natural resistance during puncture and a natural flashback of blood
- When the needle is withdrawn, both veins and skin will self seal so that the site of puncture is not visible to the next student
- No setup for instructors as pads are pre-filled with simulated blood
- The IV Torso comes with a carry case for easy transportation and storage

Product features:

- The IV Torso enables the practice of IV access to the:
 - External jugular vein
 - Internal jugular vein via the anterior, central and posterior approach
 - Subclavian vein
 - Femoral vein
- A pulse bulb enables the instructor to create a palpable pulse in the manikin's arteries
- Long catheters can be placed into the training model
- Realistic tissue simulation
- Both Neck Pad and Femoral Pad are replaceable
- Pads can be replaced without use of any tools

E/D/F/I/S/NL/NO/FIN/J

9985-1008937

Options and Replacements for 9985-1008937

Art. No.	Description
9985-1008938	Neck pad
9985-1008939	Femoral pad

Central Venous Cannulation Simulator

This simulator allows the practice of CVC technique and is designed for the emergency medical field as well as those participating in ACLS and ATLS programs. Anatomically accurate, palpation is exactly the same as on a patient. The sternal notch which "sinks" when palpated, sternocleidomastoid, clavicle and other supporting features can be felt. Internal blood vessels include subclavian vein, internal jugular vein, external jugular vein and carotid artery. The use of a Swan-Ganz catheter is possible. The neck of the simulator is positioned to the left, making visible landmark identification easy. Delivered with removable skin, tubing sealant, needles, artificial blood and carrying case.

44x26x49.5 cm; 15.5 kg

E

9985-1005595



9985-1005239

Infant IV Arm

Lifelike reproduction of an infant arm for mastering extremity venipuncture procedures and fluid administration in the superficial veins of the hand. Venipuncture possible in antecubital fossa and dorsum of the hand. Fluid may be infused for realistic flashback.

1.4 kg

E

9985-1005239



9985-1005242

Infant IV Training Leg

Lifelike reproduction of an infant leg allows students to master extremity venipuncture procedures and intravenous fluid administration in the superficial veins of the foot. Venipuncture possible in medial and lateral malleolus sites. Heel stick simulation. Fluid may be infused for realistic flashback.

1.4 kg

E

9985-1005242

Deluxe Venous Access Device Model

Teach patients and healthcare staff the care and use of two different types of catheters with this model. Features left and right subclavian catheter connections that may be flushed with water; implanted venous access system with a "skin" flap over the implant to allow viewing. Made of skinned, lightweight urethane foam, this model may be washed with soap and water, or painted with antiseptics. Mounted on a collapsible easel and packed in its own carrying case.

38.1x53.3 cm; 4.5 kg

E

9985-1005563



9985-1005563



9985-1005595

Options and Replacements for 9985-1005563

Art. No.	Description
9985-1005564	Skin Flap

Options and Replacements for 9985-1005595

Art. No.	Description
9985-1005611	Artificial Blood, 1 litre



9985-1009801

NEW

Chester Chest™ – With a New, More Advanced Arm

Chester Chest™ is an unequalled teaching aid which makes it possible to learn how to use the following long term vascular accesses perfectly:

- Implanted Port
- Central Venous Catheter (CVC)
- Peripherally Inserted Central Catheter (PICC)

The new, more advanced arm has a double lumen 5FR-PICC (Peripherally Inserted Central Catheter), which comes out of the V. basilica – the preferred access. In the area of the PICC catheter there is a cavity for inserting a peripheral port (this port is pictured but is not included with the delivery). A further feature of the new arm is a 20G IV catheter in the lower arm. The new, more advanced arm has greater rotation and extension than the previous model and can be used for practising cleaning, applying bandages and fixings, as well as inserting and removing IVs. The right side of the chest has been equipped with a surgically placed CVC (central venous catheter). Furthermore, catheters can be inserted into the V. jugularis externa and into the V. subclavia via the openings provided. The left side of the chest has an implanted port. Using the various tissue flaps provided, difficult insertions can be practised: deep, slanted, slipped or wandering ports. Chester Chest™ can be used in a upright or horizontal position. It is delivered with a blood reservoir bag, talcum powder and instructions for use.

E

9985-1009801

Options and Replacements for 9985-1009801

Arm

Permits suturing of an implanted peripheral port and attachment to a "blood" reservoir. A tissue flap is placed over implanted port for the realistic practice of palpation and accessing. Port is not included.

1.4 kg

9985-1005840

Carrying Bag

Soft sided case
55x43x42 cm; 1.1 kg

9985-1005839

Replacement Skin, 0.9 kg

9985-1005841

I.v. Injection Arm

This injection arm, made of 3B SKINlike™ silicone, is unique in quality and design and allows realistic training to teach competence to medical staff. It is also very suitable for group instruction because of its high quality, stain resistance and easy-to-clean soft material. It is ideal for practicing:

- Intravenous injections
- Correct puncture of peripheral veins for blood sampling. The following veins can be punctured: basilic vein, cephalic vein, median cubital vein, dorsal venous rete of hand
- Positioning of a butterfly cannula

Delivered with stand, artificial blood, 2 replacement tubing systems, plastic bottle, syringe and deluxe storage carton.

74x19x14 cm; 3.2 kg

E/D/S/F/P/J [www.](http://www.3bscientific.com)

9985-1000509

Options and Replacements for 9985-1000509

Art. No.	Description
9985-4000158	Replacement Skin
9985-4000155	Infusion Bottle (250 ml)
9985-4000160	Artificial Blood
9985-4000156	3 Tubing Systems



SKINlike™

9985-1000509



9985-1005777

Geriatric IV Arm

Developed from a living cast, this arm is unique. Its properties include veins that roll away or disappear as you attempt to catheterize the vessel and a specially developed skin that is exceptionally thin. If your students work with the aged, this addition to your teaching lab will enable them to better serve in the future.

91x36x23 cm; 10 kg

E

9985-1005777

I.v. Training Hand

An economic and easy to transport model to train i.v. injection.

Made of durable material for repeated use. Features include:

- Palpable veins, lifelike vein roll-over
- Suitable for blood sampling or fluid injection
- Supplied with carrying tray and artificial blood

35x13x5 cm; 0.8 kg

E

9985-1005754

Options and Replacements for 9985-1005754

Art. No.	Description
9985-1005755	Hand Skin
9985-1005756	Arm/Hand Vein Set
9985-1005757	Reservoir Blood Bag

Pressurised Cannulation Pad

This Pressurised Cannulation Pad has been introduced to provide an portable intravenous trainer and act as an alternative to using the traditional arm. These trainers are realistic and achieve relatively low running costs.

- There is one blood vessel that is set into a fleshy pad at variable depths
- The Pressure is provided by a simple squeeze on the bulb into a fluid reservoir

- Both skin pad and vessels are replaceable

27x24.5x10 cm; 1.0 kg

E

9985-1005167



9985-1005754



9985-1008940

I.v. Injection Simulator

This compact, lightweight training pad is designed to be attached to the lower arm by means of straps with a Velcro closure and is an ideal complement to our Patient Care Simulators. The thick and thin veins under the skin wind their way directly under the surface and deeper, to allow practicing puncture techniques for blood sampling and injection in a realistic manner. Delivered with blood bag, but without artificial blood and stand.

E/J

9985-1008940

Options and Replacements for 9985-1008940

Art. No.	Description
9985-4000160	Artificial Blood
9985-4000157	Stand



9985-1005167

Options and Replacements for 9985-1005167

Art. No.	Description	Dimensions
9985-1005168	Cannulation Pad	27x24,5x10 cm; 0.8 kg
9985-1005169	Replacement Tubing	20x1,2x1 cm; 0.1 kg



Advanced Venipuncture and Injection Arm, white skin tone

This revolutionary training arm provides complete venous access for IV therapy and phlebotomy, plus sites for intramuscular and intradermal injections. An extensive 8-line vascular system allows students to practice venipuncture at all primary and secondary locations, including starting IVs and introducing Over the Needle IV Catheters. The venous system simplifies setup with only one external fluid bag supplying artificial blood to all veins simultaneously. The dorsal surface of the hand includes injectable metacarpal, digital and thumb veins. Venipuncture can be performed along the basilic, cephalic, accessory cephalic, and median antebrachial veins. Intramuscular injections may be performed in the deltoid muscle and intradermal injection sites are located in the upper arm. Intramuscular injections into the deltoid muscle are enhanced by the soft, lifelike skin and by the natural bony landmarks in the region. Intradermal injections using distilled water will create characteristic skin welts at designated sites on the upper arm. The soft, flexible fingers are molded separately with close attention paid to every detail – right down to the fingerprints! Flexion of the wrist helps students develop manipulation skills. The replaceable skin rolls as the veins are palpated, and a discernable “pop” is felt when entering the veins. Valves in the veins can be seen and palpated on the skin surface. Under normal use, hundreds of injections may be performed before the veins or skins need to be replaced. Complete replacement kits are available and easy to use.

Delivered with artificial blood, 3cc syringe, 12 cc syringe, needle, two fluid bags, instruction manual and carrying case.
89x30.5x15 cm; 10.0 kg

E

9985-1005678

Advanced Venipuncture and Injection Arm, dark skin tone

Same as 9985-1005678.

E

9985-1005679

**Replacement for 9985-1005678:
Skin and Vein Replacement Kit, white skin tone, 1.2 kg**

9985-1005688

**Replacement for 9985-1005679:
Skin and Vein Replacement Kit, dark skin tone, 1.2 kg**

9985-1005689

**Replacements for 9985-1005678 and 9985-1005679:
Vein Replacement Kit, 0.6 kg**

9985-1005690

Blood, 950 ml, 0.2 kg

9985-1005611

Blood, 3800 ml, 0.4 kg

9985-1005691

Fluid Supply Stand, 2.4 kg

9985-1005692

Fluid Supply Bag, 500 ml, 0.1 kg

9985-1005693

Injection Arm

This right arm combines all features required for i.v., i.m. and subcutaneous injection and infusion training as well as blood collection exercises:

- I.v. injection in subtle venous network of arm and hand: cephalic, basilic, antecubital, radial, and ulnar veins. A pressure bulb enables increase or decrease of venous pressure
- I.m. injection in deltoid area
- Subcutaneous injection on the volar side of the forearm and the lateral side of the arm

Supplied with artificial blood, blood dispensing bag, funnel, talcum powder, replacement skin and veins, base and carrying bag.
76x15x15 cm

9985-1005809



9985-1005809



Intramuscular Injection Simulator

This high quality simulator represents a left upper arm with all important anatomical palpable landmarks such as acromion and humerus. It allows practice of correct intramuscular and subcutaneous injections in an exceptionally accurate way. The built in fine electronics produce audio visual feedback of the result, e.g. correct or incorrect injection or bone contact or incorrect localization. Additional training and control modes provide either an immediate or later performance check under training conditions. The lifelike silicone skin is extremely durable and can be quickly and easily exchanged when necessary. The simulator is supplied with 2 AA batteries, detailed instruction manual, replacement skin, 5 ml syringe and 21G/0.8 injection needle.

32x14x12 cm; 0.9 kg

E/D/S/F/P/I/J www.3b.com

9985-1009840



9985-1009840



Options and Replacements for 9985-1009840

Replacement Skin

9985-4000163



9985-1000511



9985-1008941

Intramuscular Injection Simulator – Upper Leg

This high quality simulation of a right upper leg realistically displays all of the important anatomical, palpable landmarks such as patella and greater trochanter. It also allows very realistic practice of correct intramuscular injections. The built in fine electronics produce audio visual feedback of the result, e.g. correct or incorrect injection, bone contact or false localization. Additional training and control modes optionally provide an immediate or delayed performance check under training conditions. The lifelike silicone skin is extremely durable and can be exchanged quickly and easily when necessary. The simulator is supplied with two AA batteries, detailed instruction manual, 5 ml injection syringe and 21 gauge (0.8x50 mm) injection cannula.

E/D/S/F/P/I/J www.3b.com

9985-1000511



I.m. Injection Simulator

The student can use this injection simulator to practice both intramuscular and subcutaneous injections in the upper arm. The simulator can be attached easily using the stick-on tape. The student can find the injection site by feeling for the acromion. LED lights will show whether the injection has been inserted in the correct place to the right depth. The warning signal will sound if the injection is carried out incorrectly.

Water only should be used for injecting.

The delivery contents include the liquid pouch and the stick-on tape.

42x15x1 cm, 0.75 kg

E/J

9985-1008941

Intradermal Injection Simulator

The simulator features a forearm from the wrist to just below the elbow. Vinyl skin provides realistic feel and appearance to ensure a realistic training experience. The simulator features eight sites for practicing intradermal injections. If fluid is properly injected, a characteristic skin welt will form. The welt is removed by withdrawing the fluid after practice. Each site is reusable by dozens of students. Supplied with sealant, syringe and storage box.

33x28x13 cm; 0.9 kg

E

9985-1005628



9985-1005190

Intra-muscular Injection Pad

A simple trainer that simulates muscle tissue.

- Injection made to a depth of 50mm
- Has a life like skin
- Will absorb fluid

9985-1005190



9985-1005628



9985-1000514

Buttock Injection Simulator

This high quality, strap on simulator is a lifelike model of a right buttock with all important anatomical landmarks for intramuscular injections (i.m.): iliac crest, anterior superior iliac spine and greater trochanter. The integrated fine electronics provide clear feedback when training the intramuscular injection technique: correctly administered injections will produce audiovisual feedback. Additional training and control modes are available for checking results either immediately or upon completion of a training session. Supplied with 21G/0.8 injection needle and 5 ml syringe.

30x30x12 cm, 2,3 kg
 E/D/S/F/P/I/J www.

9985-1000514

Two-in-One i.m. Injection Model of Buttock

This unique model of an human buttock has a special two-in-one function: On the right hand side, the anatomy of the bones, ilium crista, greater trochanter, m. gluteus medius, nerves and veins can be studied through the transparent outer structure. The student can transfer what he has learned about the position of nerves, veins etc. to the left hand side on which intramuscular injections can be practiced. Anatomical landmarks can be palpated through the soft skin to identify the correct positions for injection. The injection of fluid (water) is possible. Correct injections are confirmed by a green light, if the injection is placed in a wrong position or too deep, a red light will appear and a buzzer will sound.

38x35x22 cm; 5 kg

E/J

9985-1005394



9985-1005394

I.m. Injection Simulator

This simulator consists of an accurately modelled buttock with thighs to allow intramuscular injection by finding the correct injection region and needle insertion angle. The skin and muscle texture feel very lifelike, palpable anatomical landmarks such as the superior end of the femur (greater trochanter), posterior and anterior superior iliac spines and the sacrum can be felt. A section of the upper lateral quadrant of the left gluteal area is cut away to show the underlying structures. Clearly shown are the gluteus medius and gluteus maximus muscles, sciatic nerve and vascular structures. With this simulator you can practice gluteus medius, ventrogluteal and vastus lateralis injections. Supplied with syringes and carrying case.

56x24x40.5 cm; 8.5 kg

E

9985-1005586

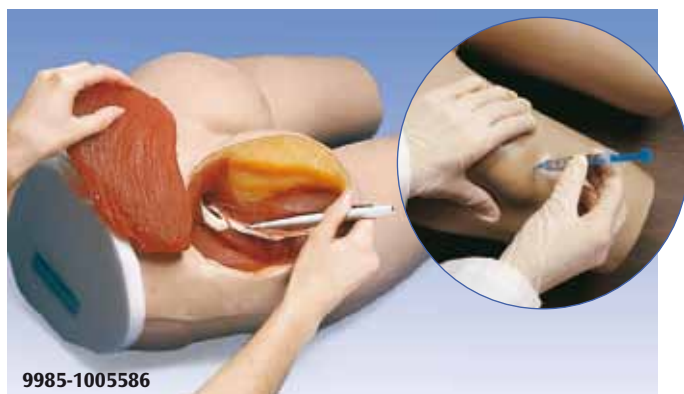

9985-1005586

Buttockmate – i.m. Injection Simulator

This easy to handle simulator of a human buttock can be fastened like a belt on the body of a student or a training doll. It allows practicing of intramuscular injections and also the injection of fluid (water) is possible. If the injected part is incorrect, a buzzer, which works with a 9 volt battery and a red light, will give a warning sound. The durable, soft and very realistic skin shows no needle marks even after many exercises.

14x34.5x49.5 cm

E/J

9985-1005395



9985-1005395

Spinal Injection Simulator

This accurate replica of the lower back with spinal column and spinal cord insert ensures proper resistance in needle puncture and accurate palpation of reference points. The simulator allows one to practice spinal, epidural, caudal, sacral and lumbar injection techniques. The spinal column can be charged with fluid to simulate the liquor cerebrospinalis and the simulator can be placed in a sitting or lateral position. The functional portion of the simulator includes L3-L5 vertebrae (L1 and L2 section are visible) plus the sacrum and coccyx. Supplied with fluid bottle, connectors and carrying case.

48x44.5x26.5 cm; 12.0 kg

E

9985-1005603



9985-1005603



9985-1005237

Baby "Stap"

Reproduction of a neonatal infant positioned for the practice of lumbar puncture techniques. Lateral decubitus position. Realistic inter-changeable spine with spinal cord may be palpated for location of correct puncture site. Fluid may be infused.

1,4 kg

E

9985-1005237



9985-1005153

Lumbar Epidural Injection Trainer

The Trainer is designed to help trainee anaesthetists acquire the necessary tactile skills for epidural anaesthesia prior to hands-on patient experience. If the epidural needle is inserted too deeply a slight resistance is felt before the needle penetrates the dura. Features found in the trainer include:

- Tactile and visual access to the lumbar spine, the epidural space and the dural sac
- Can be positioned in lying or lateral recumbent position
- Spinous processes and the interspinous spaces are palpable beneath the skin
- Epidural injection is carried out using either air or saline to detect loss of resistance and if accidental dural puncture occurs, "cerebrospinal fluid" will appear.
- Can be easily dissembled at any time to show position of needle during penetration
- Consists of skin, muscle layer, ligamentum flavum, vertebral bones and intra-spinal ligament
- Supplied with an all metal Tuohy needle and a loss of resistance syringe 27x210x110 cm

E

9985-1005153

Options and Replacements 9985-1005153

Art. No.	Description
9985-1005154	Smooth White Skin
9985-1005155	Lig. Flavum, Vertebral Bones and Intraspinal Ligament
9985-1005156	5 Spinal Cord Fluid-Filled Sachets
9985-1005157	Muscle Layer
9985-1005158	Instrument Kit (puncture needle and syringe)





9985-1005102

Intubation Head

This model is especially designed to instruct and practice endotracheal intubation. The accurately modelled life size head allows the correct depth, angle, and pressure of insertion of a laryngoscope to be taught. Mounted on base. Delivered without laryngoscope. 21x16x17.5 cm; 0.6 kg

E

9985-1005102



9985-1005698

Advanced Child Airway Management Trainer

Present your students with the challenges they may face in the real world. Advanced Child Airway Management Trainers offer tongue swelling and laryngospasm. This advanced airway management trainer is perfect for practicing skills on paediatric patients and represents the size of an 8 year old patient. Practice intubation, ventilation, suction, and jaw thrust techniques. Realistic anatomy and landmarks include teeth, tongue, oral and nasal pharynx, larynx, epiglottis, arytenoids, false and true vocal cords, trachea, lungs, oesophagus, and stomach. The trainer allows you to practice oral, digital, and nasal intubation, as well as E.T. (Endotracheal Tube), E.O.A. (Oesophageal Obturator Airway), P.T.L. (Pharyngeal Tracheal Lumen), L.M.A. (Laryngeal Mask Airway), E.G.T.A. (Oesophageal Gastric Tube Airway), and Combitube® insertion. Separate lungs for auscultation. Inflatable stomach bladder indicates oesophageal insufflation. With its slightly anterior position, swelling tongue, and vocal cords, the Advanced Child Airway Management Trainer is a great trainer for introductory as well as advanced training. Includes training stand to mount head, pump spray lubricant and hard carrying case.

E

9985-1005698



9985-1005633

Intubation Head

This trainer simulates a non anaesthetised patient and features anatomical landmarks such as: teeth, tongue, oral and nasal pharynx, larynx, epiglottis, arytenoids, false cords, true vocal cords, trachea, lungs, oesophagus, cricoid cartilage and stomach. Supplied with stand, pump spray lubricant and hard carrying case. The following airway management procedures can be trained:

- Intubation (oral, digital and nasal)
- E.T. (Endotracheal Training)
- E.O.A. (Oesophageal Oral Airway)
- P.T.L. (Pharyngeal Tracheal Lumen)
- Combitube® insertion
- Ventilation and suction techniques
- Proper cuff inflation
- Sellick manoeuvre (applying cricoid pressure changes the position of the trachea and closes the oesophagus)

63x30.5x40.6 cm; 15 kg

E

9985-1005633

Options and Replacements for 9985-1005633

Art. No.	Description
9985-1005607	Lungs
9985-1005608	Stomach



9985-1005325

Intubation Trainer™

The Intubation Trainer™ is the ideal tool for physicians, paramedics, nurses, lung specialists and other medical professionals to train endotracheal intubations.

The product comes with a standard USB port and is compatible with the operating systems Windows 98, 2000, ME and XP.

Benefits of the Intubation Trainer™:

- See and understand the anatomy of the upper airways
- Learn the correct positioning of the tube in the trachea and correct handling of the laryngoscope
- Real time feedback of eye-hand coordination
- Procedure recording capability improves inclusion of the whole study group during a session

The Intubation Trainer™ can be used with our following models:

9985-1005396, 9985-1005649, 9985-1005633, 9985-1005214, 9985-1005827

Supplied with: case, software, driver, instructions, camera.

E

9985-1005325





9985-1005396

Endotracheal Intubation Simulator

In securing an airway, endotracheal intubation requires the highest skills and is accompanied by risks. To enable you as emergency medical staff to perform intubations, you should certainly use every opportunity to practice. This intubation simulator provides exceptionally good and realistic intubation training, enabling you to:

- Acquire both the skill of oral and nasal tracheal intubation
- Acquire the skill of handling supraglottic airway devices (e.g. laryngeal mask airway, oesophageal gastric tube airway)
- Confirm left and right air sound with a stethoscope
- Determine ventilation of one lung
- Determine accidental oesophageal intubation
- Usage of the laryngoscope and training of securing airways can be trained almost like on a living body.
- Neck flexion and head extension
- Advancement of the mandible

Tongue, epiglottis and pharynx are reproduced realistically, with the tongue and mouth made of soft material. The front teeth (upper four) are made to break when pressure is exerted incorrectly and the teeth are used as a fulcrum while using a laryngoscope. Determining incorrect intubation is possible! When intubation and ventilation were carried out correctly, this is shown by simultaneous rising of the left and right chest. When only one lung is ventilated, the error is shown in that only one side will rise. When the tracheal tube has been mistakenly intubated into the oesophagus and air is sent, the abdomen will rise (stomach inflation), making it possible to determine the error. Parts of the model are purposefully made to be damaged if handled roughly. Accessories: 3 teeth, silicone oil, carrying case. Ventilation bag, tube, stethoscope and laryngoscope are not included in scope of delivery. 75x45x24 cm; 6.2 kg

E

9985-1005396



9985-1005214

Airway Management Trainer

Realistic practice is the key to developing proficiency in airway management skills. The Airway Management Trainer's lifelike upper torso and head simulates real world complications when practising a variety of intubation, ventilation and suction techniques.

- Realistic anatomical features allow demonstration of Sellick Manoeuvre and laryngospasm
 - Practical training in clearing an obstructed airway and suctioning of liquid foreign matter
 - Provides visual inspection of lung expansion and auscultation of breath sounds
 - Simulates stomach inflation and vomiting situation
 - Airway demonstration model is standard with each trainer
 - Can be used with trachlight products
 - Improved airway allows insertion of laryngeal mask airway and combitube
- Includes: Manikin on sturdy board, airway demonstration model, cleaning kit, lubricant, carry case, and directions for use. 75x27x45 cm; 15 kg

E/D/F/S/J/SE/FIN

9985-1005214

Replacements for 9985-1005396

Art. No.	Description	Dimensions
9985-1005397	Front Teeth Set of 3	–
9985-1005399	Synthetic Skin for the Body (skin-coloured)	8x2x2 cm; 0.01 kg
9985-1005400	Lubricant (silicon oil)	23x18x16 cm; 3.5 kg

Replacements for 9985-1005214

Art. No.	Description	Dimensions
9985-1005215	Airway Demonstration Model	20x10x10 cm; 0.22 kg
9985-1005216	Concentrated Simulated Vomit	8x2x2 cm; 0.01 kg
9985-1005217	Airway Lubricant	23x18x16 cm; 3.5 kg

Emergency Laryngoscope

- Fibre optic handle for two C batteries (2.5 V Halogen)
- Mac 3a blade made of special plastic
- Robust and unbreakable
- Exceptional strength with low weight
- Patient friendly with reduced risk of injury or damage of teeth
- Blade does not "freeze" at low temperatures Supplied with zipper pouch. 19x11x4 cm; 0.26 kg

9985-1003657

Deluxe Laryngoscope

- Fibre optic handle for two C batteries (2.5 V Halogen)
- Mac 3 fibre optic blade
- Modular construction – swap modules in a few seconds
- Ideal Mac shape with no light pipe in the line of sight
- Blade module made entirely of stainless steel
- Bright white light from 3.5 mm F.O. bundle Supplied with zipper pouch. 19x11x4; 0.26 kg

9985-1003659



9985-1003657

9985-1003659

Replacements for 9985-1003657 / 9985-1003659

Art. No.	Description
9985-1003658	6 Halogen Bulbs 2,5 V



9985-1005827

Intubation Torso

This upper torso features:

- Realistic chest cavity with trachea, bronchi and lungs, heart and stomach
- Nominal 18 mm airway
- Anatomically accurate mouth, tongue, airway and oesophagus
- Fully articulating head, neck and jaw
- Wide, straight, stiffer epiglottis and realistic vocal cords
- Soft neck with cricocartilage

The following airway management procedures can be performed:

- Head tilt /chin lift, jaw thrust and neck extension into the sniffing position
- Placement of cuffed ET tubes and EOA (Oesophagus Obturator Airway)
- Intubation (oral, digital, nasal)
- Sellick manoeuvre
- Observation of unilateral or bilateral lung expansion under positive pressure ventilation
- Surgical placement of tracheotomy tube
- Emergency needle cricothyrotomy stick
- Bilateral tension pneumothorax decompression

Supplied with 6 neck collars, 3 cricocartilages, membrane tape and carrying bag. Laryngoscope and tube are not included in scope of delivery.

76x56x30.5 cm; 11.4 kg

E

9985-1005827



9985-1005774

Adult Airway Management Trainer

Detailed anatomy featured on the adult intubation trainer stands out. Get a clear picture of human anatomy from the sculpted alveolar sac, bronchial tree, and blood vessel structures of the cross sectioned and exposed flexible lungs, to the interior main bronchus and oral / nasal pharyngeal spaces. Combine these details with an airway complicated by breakout teeth, tongue oedema, and laryngospasm, and this airway trainer rates hard. An anatomical stomach that swells with oesophageal intubation, or excessive pressure with the BVM during rescue breathing, together with the vomiting capability of this manikin makes this an exceptional educational tool for multitasking. Includes instructions for use, soft carry bag, lubricant and replaceable lungs and stomach.

84x64x30 cm; 20 kg

E

9985-1005774



9985-1005780

Economy Adult Airway Management Trainer

This detailed adult intubation head comes mounted for clinical teaching and practice of advanced airway management. Intubation procedures and skills, including anatomy knowledge and recognition, endotracheal intubation, nasotracheal intubation, use of field emergency airway adjunct tubes like LMAs and Combitube, securing, and suctioning, and maintenance of the installation can all be practiced with this unit. A soft carry bag, lubricant, and instructions for use are included. Without tube.

53x23x25 cm; 4.5 kg

E

9985-1005780



9985-4006668 *
9985-1001502 **

You will find our large selection of Charts starting on page 108.

9985-4006518 -
9985-1001157 +

Suture Practice Leg

Made with a soft vinyl skin over a core of stitchable foam to provide a life like suturing experience for students or a realistic suturing demonstration by an instructor. Realistic skin texture with wrinkles and pores. Soft and pliable for easy sewing, the skin is tough enough that sutures will not pull out when tightened. Each unit provides three "wounds". These "wounds" can be sutured repeatedly until the skin around them is finally worn out; then, new "wounds" can be cut. Although disposable, the trainers provides hundreds of suturing experiences before wearing out. Conservatively, over one hundred cuts can be made on the trainer and each of these cuts can be sutured several times. Suture Practice Leg is complete with a starter suturing kit and instruction booklet.

2.0 kg

E

9985-1005683

Suture Practice Arm

This arm is made of a soft vinyl skin over a foam allowing hundreds of suture practice sessions. The arm comes with 3 wounds, as well as several cuts which can be placed all over the arm, hand and fingers and sutured several times. The soft and pliable material guarantees the sutures will not pull out when tightened. Delivered with a starter suturing kit. Like 9985-1005683. 62x18x13 cm; ca. 1.0 kg

E

9985-1005585



9985-1005683

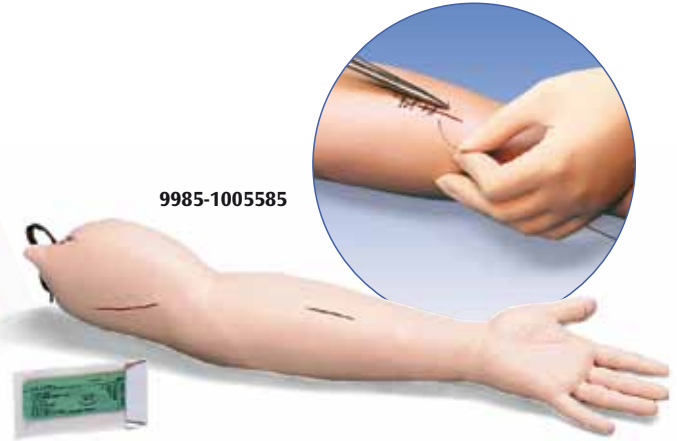

9985-1005585

Surgery Trainer

Surgery Trainer allows open surgery practice and offers an advanced skills capability for cut and suture practice. The single sided skin pad and a piece of abdominal bowel (which can be anastomosed) are replaceable.

- Highly portable
 - Rubber suction feet secure the base providing easy working conditions
 - Washable, durable and all parts are replaceable
- Sutures and string not provided.

25x23x9 cm

E

9985-1005144

Suture Practice Trainer

This is a basic skill trainer which offers a limited facility for knot tying. The foam can be turned over and or replaced.

- Highly portable
 - Rubber suction feet secure the base providing easy working conditions
 - Washable, durable and all parts replaceable
- Sutures and string not provided.

E

9985-1005147



9985-1005144

Options and Replacements for 9985-1005144

Art. No.	Description
9985-1005145	Single Sided Skin Pad, 6x9 cm
9985-1005146	Two Layered Abdominal Bowel, 2x9 cm
9985-1005149	Two Layered Abdominal Bowel, 3x27 cm



9985-1005148

9985-1005147

Options and Replacements for 9985-1005147

Foam Pad

9985-1005148



9985-1005135

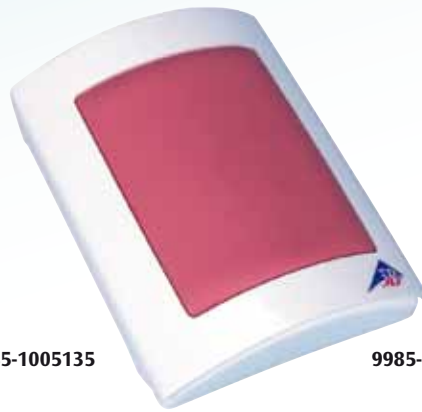

9985-1005134



9985-1005139

Surgery and Laparoscopy Torso

This trainer is aimed at all levels of surgeons in training whose surgical skills require extra practice. Once set up, the torso can be used to self educate using his / her preferred surgical laparoscopic instrumentation for a variety of techniques. The Torso has the following features:

- Can insufflate and maintain air tight pressure
- Supports usage of wet tissue or prepared artificial materials
- Can be used for surgical diathermy. There is a fixed metal plate in the base of the unit with a connection on the outside to enable earthing
- Can be easily cleaned by flushing out through a large airtight drain plug
- Is light weight and has a carrying handle

75x55x22.5 cm

E

9985-1005135

Skin Suture Trainer

A great low cost way to practice surgical opening and closing techniques.

Features:

- Economical reversible pad
- The material has been designed to make complex incisions such as “flap and dog turn” suturing more realistic
- A sub-dermal layer is present so that it is possible to make secure intra-dermal sutures
- Base has suction feet to enable slip free use

11x14 cm

E

9985-1005134

Laparoscopic Trainer

The Portable Laparoscopic Trainer is designed to provide low cost assistance in laparoscopic training.

- Supplied with 4mm black Neoprene skin
- Simple to assemble and ready for use in seconds
- Works with wet tissue (eg. Pig liver) or dry (eg. foam)

E

9985-1005139

Options and Replacements for 9985-1005135

Organ Board

The Organ Board allows trainers to prepare specimens in advance for use in the Surgery and Laparoscopy Torso. The board has a simple interchangeable push-peg and hoop-tie system for securing specimens. A diathermy plate is mounted on the board. Furthermore, suction feet provide a firm fixing for the board within the torso.

E

9985-1005136

9985-1005136



Neoprene Sheets

9985-1005137

Abdominal Skin with Fatty Tissue

A smooth soft tissue multi functional skin pad with a pink surface and a yellow fatty tissue layer, 12 mm thick. Ideal to practise trocar incisions or larger incisions and can be sutured. Realistic tactile feeling when surgical zips or gloves are used.

9985-1005138

Options and Replacements for 9985-1005134

Double Sided Skin Suture Pad

9985-1005133

Options and Replacements for 9985-1005139

Pink Skin with Fatty Tissue

9985-1005140

Support Sheet for Pink Skin

9985-1005142

Transparent Skin for Daylight Use

9985-1005143



9985-1005140



9985-1005143



9985-1005150

Abdominal Open and Closure Trainer

The Advance Abdominal Open and Closure Skin Pad has been developed to simulate real skin tissue and for ease of use by course organisers doing basic surgical courses. It is supplied with a pink skin surface with subdermis for intra-dermal suturing. A white Linear Alba makes up a further layer.

- Easy maintenance, requiring only a set of balloons and set of skins
- Up to 4 good incisions can be made from each set of skins
- Skins cut and suture well
- Included with the kit are four balloons and a set of skins (1 red, 1 white)
- Internal planes within the unit prevent the balloon from moving around
- Rubber suction feet secure the base providing easy working conditions

E

9985-1005150

Replacements for 9985-1005150

4 Balloons and 2 Skins

9985-1005151



9985-1005151

Chest Drain Simulator

FOR ADVANCED TRAUMA LIFESUPPORT COURSES

This innovative design not only simulates realistic body tissue but provides an alternative to the use of animals. The design is unique in having a replaceable chest wall with ribs that are encased into the realistic simulated flesh that forms the torso. This fleshy part is replaceable and can be used for up to 25 incisions. It is housed in a white plastic torso-shaped box that is firmly secured and has strong sucker-feet to ensure non slip use on smooth table-top surfaces. The torso presents as a patient lying on his back.

- Surgical access is lateral to the pectoralis major
- The arm has been removed for easier access and extended for anatomical relevance
- The ribs can be clearly felt below the surface of the skin
- Trainees can make an incision through the fleshy part, surgically dividing the tissue with blunt forceps until the plural cavity is clearly felt by finger insertion
- Complete finger rotation is possible, allowing the trainee to ensure that there are no obstructions before a drainage system can be introduced
- The popping effect of passing through the pleura is realistic and a unique feature
- A drain can be securely sutured into position onto this simulated flesh
- The trainer needs no preparation, no refrigeration, no messy disposal after use and no unpleasant odours

Trainer includes a replaceable:

- Chest wall
- Pericardiocentesis where fluid can be drawn into a syringe
- A realistic Tension Pneumothorax where air can clearly be heard and felt exhaling between the 2nd and 3rd ribs

57x37x43 cm; 4.8 kg

E

9985-1005175

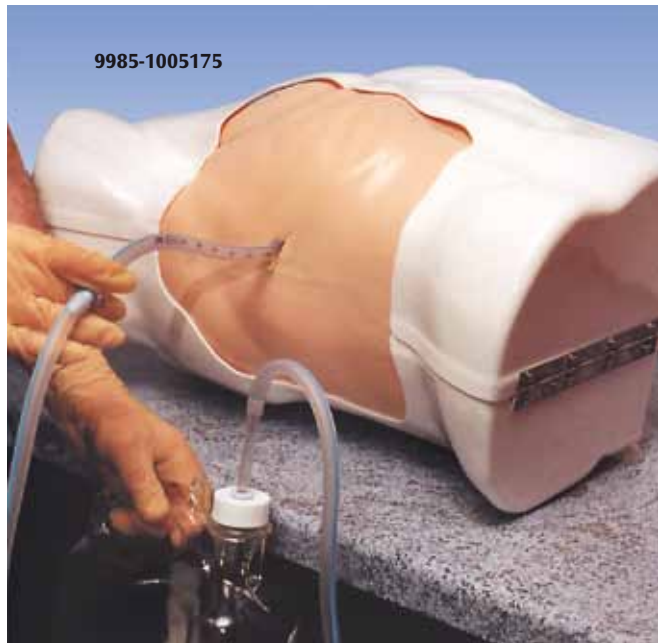

9985-1005175

Replacements for 9985-1005175

Rib Cage

9985-1005176

Pneumothorax Kit,
18x18x8 cm; 0.4 kg

9985-1005177

Pericardiocentesis Kit,
1x70x70 cm; 0.2 kg

9985-1005178

Carrying Bag,
17x36x30 cm; 4.8 kg

9985-1005179



9985-1005177



9985-1005178



9985-1005745

9985-1005203

Baby CPR Manikin

This economical CPR manikin uses a single-use airway/lung/face shield system which requires no cleaning, no disinfecting and no disassembly. Features include:

- Realistic chest rise
- Anatomical landmarks such as sternum, ribcage and sub-sternal notch

66x20.3x20.3 cm; 1.8 kg

E

9985-1005745

Newborn CPR Manikin

Economically priced, this manikin of a newborn has a lightweight, rugged, foam filled body with no internal parts to break. Features include:

- Lifelike anatomical landmarks such as nipples, xiphoid process and sub-sternal notch
- Easy to replace mouth/nose pieces
- Disposable airways with uni-directional valves
- Soft carrying bag

66x20.5x20.5 cm; 2.3 kg

E

9985-1005728

Baby (6 to 9 months) CPR Manikin

All other features same as 9985-1005728.

66x20.5x20.5 cm; 2.8 kg

E

9985-1005731

Child CPR Manikin

All other features same as 9985-1005728.

86.5x28x18 cm; 4.1 kg

E

9985-1005733

CPR Resusci Baby with Skillguide

The Resusci Baby offers a good starting point for quality CPR training. The addition of the SkillGuide indicator provides objective feedback of key CPR elements in real-time.

- Head tilt/ chin lift is required to open the airway
- Bronchial pulse simulation
- Economical, disposable airways for quick and easy clean up
- Removable, reusable faces
- Skillguide CPR Performance Indicator provides immediate feedback on ventilation duration and volume, compression depth, and finger placement

Includes: A plastic Carrying Case, Skillguide unit, 3 Resusci Baby Faces, 6 Resusci Baby Airways, 6 Manikin Wipes, Pulse Bulb, Tubing, and Directions for use.

57x38x15 cm; 5.6 kg

E/D/F/S/J/NO/SE/I/NL

9985-1005203



9985-1005728,
9985-1005731,
9985-1005733

Options and Replacements for 9985-1005745	Replacements for 9985-1005203	Options and Replacements for 9985-1005728	Options and Replacements for 9985-1005731	Options and Replacements for 9985-1005733
Carrying Bag 9985-1005744	Resusci Baby Faces , (pkg. 6), 25.5x22x12 cm; 1.0 kg 9985-1005209	Mouth/Nose Pieces , (pkg. 10) 9985-1005729	Mouth/Nose Pieces , (pkg. 10) 9985-1005732	Mouth/Nose Pieces (pkg. 10) 9985-1005734
Airway/Lung/Face Shield Systems , (pkg. 100) 9985-1005746	Resusci Baby Airways , (pkg. 24), 31x34x4 cm; 0.56 kg 9985-1005210	Airway Systems , (pkg. 24) 9985-1005730		Airway Systems (pkg. 24) 9985-1005735
	Resusci Baby Airways , (pkg. 96), 31x24x21.5 cm; 2.2 kg 9985-1005211		 9985-1005734	 9985-1005730



9985-1005219

CPR Baby Anne

The Baby Anne manikin meets your need for a low cost, life like infant CPR trainer. It is the perfect supplement to the Resusci Baby manikin.

- Lightweight
- Affordable price for increased hands-on classroom practice
- Realistic chest compression and rise
- Inexpensive and easy-to-maintain airway system (one airway per student)
- Unique foreign body airway obstruction feature
- Head tilt/chin lift is required to open the airway

Single pack includes 1 manikin, soft pack, 6 airways, 10 foreign body practice objects, directions for use.

50x15x20 cm; 1.8 kg

E/D/F/S/J/NO/SE/I/NL

9985-1005219

CPR Baby Anne, Dark Skin

(not shown)

All other features same as 9985-1005219.

9985-1005220

CPR Baby Anne 4-Pack

All other features same as 9985-1005219. 4-Pack includes 4 manikins, soft pack, 24 airways, 40 foreign body practice objects, directions for use "CPR Baby Anne 4-Pack".

63x28x30 cm; 6.3 kg

9985-1005221

CPR Baby Anne 4-Pack, Dark Skin

4-Pack includes 4 manikins, soft pack, 24 airways, 40 foreign body practice objects, directions for use "CPR Baby Anne, 4-Pack".

63x28x30 cm; 6.3 kg

9985-1005222



9985-1005221

Replacements for 9985-1005219, 9985-1005220, 9985-1005221, 9985-1005222

Baby Anne Faces,
(pkg. 6), 25.5x21.5x12 cm;
0.79 kg

9985-1005223

Baby Anne Faces,
Dark Skin,
(pkg. 6), 25.5x21.5x12 cm;
0.79 kg

9985-1005224

Airways,
(pkg. 24), 19x16.5x15 cm;
0.35 kg

9985-1005225

Foreign Objects
8x6x2 cm; 0.01 kg

9985-1005226

Face Connection
for Lung,
(pkg. 50), 24x16x16 cm;
0.28 kg

9985-1005227

Infant Choking Manikin

This 9 month old baby brings to you the challenges associated with foreign body obstruction in the young paediatric age group. By placing the included obstruction in the pharyngeal cavity, you will occlude the throat and initialize the need for protocol manoeuvres to remove the object. When proper hand placement occurs with sufficient force, the object expels from the mouth. Includes two objects, clothes and carrying bag.

71x20x20 cm; 3 kg

9985-1005778



9985-1005778



9985-1005229



9985-1005232

9985-1005752



9985-1005724,
9985-1005751,
9985-1005750

9985-1005228

9985-1005205

Little Junior

Developed to provide a low cost alternative for effective child CPR training without compromising realism. Little Junior continues in the same tradition as the popular Little Anne and Baby Anne manikins.

- Airway can be opened using head tilt/chin lift and/or jaw thrust technique
- Compression “clicker” provides audible confirmation of adequate compression depth
- Economical, disposable airways for quick and easy clean up
- Removable, reusable faces

Single Pack includes 1 manikin, 1 soft pack/training mat, 2 faces, 2 airways, 1 bottle of high level manikin disinfectant and directions for use. 58x26x21 cm; 2.8 kg

E/D/F/S/J/NO/SE/I/NL

9985-1005228

Little Junior, Dark Skin

All other features same as 9985-1005228.

9985-1005229

Little Junior 4-Pack (not shown)

All other features same as 9985-1005228.

4-Pack includes 4 manikins, soft pack, 8 junior faces, 8 junior airways, 4 bottles of high level manikin disinfectant and directions for use. 78x57x27 cm; 11.5 kg

9985-1005230

Little Junior 4-Pack, Dark Skin (not shown)

All other features same as 9985-1005230.

9985-1005231

Options and Replacements for 9985-1005228, 9985-1005229, 9985-1005230, 9985-1005231

Resusci Junior Faces,
(pkg. 6), 26x22x12 cm; 1.0 kg

9985-1005205

Resusci Junior Airways, Complete,
(pkg. 100), 38x28x23 cm; 3.0 kg

9985-1005206

Faces, Dark Skin,
(pkg. 6), 26x22x12 cm; 1.0 kg

9985-1005232

Resusci Junior Airways, Complete,
(pkg. 25), 36x30x6 cm; 0.64 kg

9985-1005207

Child CPR Torso

This economical CPR torso uses a single-use airway/lung/face shield system which requires no cleaning, no disinfecting and no disassembly. Features include:

- Realistic chest rise
- Anatomical landmarks such as sternum, ribcage and sub-sternal notch

E

9985-1005752

Adult Choking Torso

This life size torso allows practice of abdominal/chest thrust back blow procedures (Heimlich manoeuvre) and mouth sweep for clearing a blocked airway. When correct procedures are performed, the manikin will expel the object causing the obstruction.

Features include: Anatomical landmarks such as ribcage, xiphoid process and jugular notch. Supplied with choking objects, shirt and soft carrying bag.

79x46x25.5 cm; 7.3 kg

E

9985-1005724

Options and Replacements for 9985-1005752

Airway/Lung/Face Shield Systems, (pkg. 100)

9985-1005743

Adolescent Choking Torso
Same features as 9985-1005724.

9985-1005750

Carrying Bag

9985-1005744

Child Choking Torso
Same features as 9985-1005724.

9985-1005751



9985-1005204

Resusci Junior with Skillguide

This lifelike CPR training manikin is specially designed for child resuscitation and rescue techniques.

- Naturally occluded airway can be opened with Head Tilt/Chin Lift and Jaw Thrust techniques
 - Carotid pulse simulation
 - Convenient disposable airways to reduce clean up time
 - Removable / reusable faces
 - Uses the same faces / airways as the Little Junior CPR training manikin
- Includes: A hard plastic Carry Case, Training Mat, Skillguide Unit, Track Suit, 4 Junior Faces, 4 Junior Airways, 1 bottle of High Level Manikin Disinfectant and Directions for use.

75x27x45 cm; 12 kg

E/D/F/S/J/NO/SE/I/NL

9985-1005204

Little Anne®

The Little Anne® manikin is a realistic, inexpensive, and lightweight adult CPR trainer with all the essential features for adult CPR learning.

Product features:

- Oral and nasal passages allow realistic nose pinch required for mouth-to-nose ventilation
- Natural obstruction of the airway allows students to learn the important technique of opening the airway
- Head tilt/ chin lift and jaw thrust allow students to correctly practice all manoeuvres necessary when resuscitating a real victim
- Realistic airway function means that the airway remains obstructed without proper head tilt/ chin lift or jaw thrust. Chest rise is seen with correct ventilations
- Anatomically correct landmarks and sternal notch allow the student to practice identification of all anatomical landmarks relevant to adult CPR
- Audible feedback reinforces correct compression depth. An optional "clicker" feature signals the correct compression depth
- Realistic chest compression resistance allows the students to experience the amount of pressure needed to perform proper chest compressions in a real life situation
- Economical disposable airways for quick and easy clean-up
- Removable and reusable faces for convenient and affordable maintenance

E/D/F/S/NO/SE/I/FIN/NL/POL

9985-1008935

9985-4006725 *
9985-1001616 **

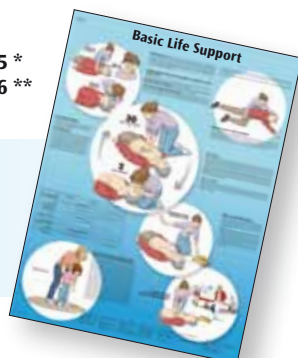

You will find our large selection of Charts starting on page 108.



Replacements for 9985-1005204

Resusci Junior Faces, (pkg. of 6), 25.5x22x12 cm; 1.0 kg

9985-1005205

Resusci Junior Airways, Complete, (pkg. of 25), 36x30x6 cm; 0.64 kg

9985-1005206

Resusci Junior Airways, Complete, (pkg. of 100), 38x28x23 cm; 3 kg

9985-1005207



9985-1008935

Little Anne Airways

(pkg. 24)

Disposable non-rebreathing airways with one-way valve are changed after each class for maximum instructor convenience and student safety.

9985-1008936



9985-1005235

Head Section Model

This true-to-scale and movable plastic model is ideal to demonstrate how to clear blocked airways. This can be done either by tilting the head back or by performing a jaw thrust.

31.5x25x2 cm; 0.34 kg

E/D/F/NO

9985-1005235



9985-1005269



Resusci Anne CPR Torso

Simulates an adult of average physiology, and is designed for realistic training of basic life support techniques in accordance with international recommendations. Features included in the manikin are:

- Natural obstruction of the airway
- Movable jaw
- Sanitary one-way valve membrane and non-rebreathing valve
- Human like compliance for inflations and compressions
- Chest rise with inflations
- Realistic landmarks for compression point location
- Carotid pulse, manual
- Use of ventilation mask or manual bag valve mask resuscitator can be practiced

Supplied with 4 face masks, 3 airways, soft transport bag/training mat, jacket, disinfectant.
73x27x39 cm; 10 kg

E/D/F/S/I/NL/NO/FIN

Resusci Anne Torso Basic with Soft Pack

9985-1005191

Resusci Anne Torso Basic with Hard Case

9985-1005263

Resusci Anne Full Body with Hard Case

9985-1005264

Resusci Anne CPR Torso with Skill Reporter and Hard Case

Same features as 9985-1005191. In addition:
Skill Reporter (Combined light signal box with printer in English language) is powered by eight 1.5 V alkaline batteries (size D) and shows CPR performance as:

- Inflation volume (insufficient/sufficient/ excessive)
- Compression depth (insufficient/sufficient/excessive)
- Wrong hand position (sides and upper part/lower centre)
- Too fast inflation
- Prints both real-time curves and statistical report of CPR performance
- Includes metronome providing a rate of 80 or 100 strokes/minute
- Allows to change between AHA (American Heart Association) and ERC (European Resuscitation Council) resuscitation guidelines
- Capability of logging CPR intervention sequence without Skill Reporter connected (for scenario-based training)
- Sensors indicate also if responsiveness and pulse were checked and if the head was tilted and the chin was lifted before artificial respiration.

Supplied with 4 face masks, 3 airways, carrying case, jacket, disinfectant.
73x27x39 cm; 17.3 kg

E/D/F/S/I/NL/NO/FIN

Resusci Anne Torso Skill Reporter with Hard Case

9985-1005193

Resusci Anne Full Body Skill Reporter with Hard Case

9985-1005269

Resusci Anne CPR Torso with Skill Guide

Same features as 9985-1005191. In addition:
Skill guide (colour light display in English language) powered by four 1.5 V alkaline batteries, size C indicating:

- Inflation volume (sufficient/ excessive)
- Compression depth (sufficient/ excessive)
- Wrong hand position
- Too fast inflation

Supplied with 4 face masks, 3 airways, carrying case, jacket, disinfectant.
72x25x43 cm; 15.2 kg

E/D/F/S/I/NL/NO/FIN

Resusci Anne Torso Skill Guide with Hard Case

9985-1005192

Resusci Anne Torso Skill Guide with Soft Pack

9985-1005265

Resusci Anne Full Body Skill Guide with Hard Case

9985-1005266



9985-1005192

Options and Replacements for 9985-1005191/ 9985-1005192 / 9985-1005193

Arms and Legs

9985-1005194

24 Airways

9985-1005197

First Aid/Trauma Arms and Legs

Featuring a selection of simulated burns, cuts and fractures. The femur includes a bleeding wound to train control/penetration of bleedings. The limbs are articulated.

9985-1005195



9985-1005195

Virkon tablets

10x5 g

9985-1005258

Manikin Face Shields

For additional hygienic conditions and aesthetic reasons. To be used with disinfected face masks. 6 rolls of 36 face shields.

9985-1005198

Full Body Carrying Case

For the upgrade of your Resusci Anne Torso with optional legs.

9985-1005199

6 Face Masks

9985-1005196



9985-1005685



9985-1005233

9985-1005234

Corpulent Manikin

Students always wonder how CPR manikins will compare with real victims, especially those who are older or obese. This unique manikin helps to prepare students to respond to a more typical cardiac arrest event with a victim who is elderly and overweight. Features: elderly physical appearance, large body type with extra "fat" layer, realistic head tilt and chin lift for opening the airway, and palpable and visual anatomical landmarks, including the sternum, rib cage, and substernal notch. The airway can be manipulated to simulate airway obstruction or choking situations. Also includes three mouth/nose pieces, three disposable lung/airway systems, and a convenient carrying bag.

9.0 kg

E

9985-1005685

Replacements for 9985-1005685

Art. No.	Description
9985-1005686	Lung/Airway Systems (pkg. of 24), 1.4 kg
9985-1005687	Mouth/Nose Pieces (pkg. of 10), 1.3 kg

Options and Replacements for 9985-1005753

Art. No.	Description
9985-1005740	Adult Airway Systems (pkg. of 24)
9985-1005741	Adult Mouth/Nose Pieces (pkg. 10)

CPR Torso

This economical torso is made of soft, realistic vinyl plastic over polyurethane foam. Features include:

- Long torso for realistic abdominal thrusts
- Realistic head tilt and chin lift for opening airway
- Anatomical landmarks such as sternum, ribcage and sub-sternal notch
- Airway can be easily manipulated to simulate airway obstruction or choking situations
- Supplied with 3 disposable lung/airway systems, 3 mouth/nose pieces and nylon carrying bag with kneeling pads

65x38x22 cm; 4.8 kg

E

9985-1005753

Pocket Mask

The Pocket Mask CPR barrier combines a low resistance one-way valve and disposable 3M™ Filtrete™ hydrophobic filter to afford superior protection to rescuers while providing life-saving ventilations to patients.

- Pre-inflated cuff allows for ease of application and makes effective seal
- Distance from patient allows rescuer to see chest rise and fall
- Versions with latex free & powder-free nitrile gloves and anti-microbial wipe help maximize user protection
- Can be used in CPR instruction courses to teach mouth-to-barrier rescue breathing
- Replaceable, disposable one-way valve and filter
- Latex free

13x10x10 cm; 0.15 kg

E/D/F/SE/NL/J/DÄN/NO/FIN/I/S

9985-1005233

Pocket Mask with Gloves & Wipe in Blue Soft Pack (each)

Same as 9985-1005233.

9985-1005234

Brad™ Compact CPR Training Manikin with Electronics

This economical CPR manikin is constructed of soft, realistic vinyl plastic over polyurethane foam for a "human" feel.

Features include:

- longer torso for realistic abdominal thrusts
- realistic head tilt and chin lift for opening airway
- can easily be manipulated to realistically simulate airway obstruction or choking situations
- a user friendly lung/airway design that eliminates cleaning.

Includes three mouth/nose pieces and three disposable lung/airway systems. Comes with an exterior console box that indicates proper hand position, adequate chest compressions, and adequate air volume Nylon carrying bag and kneeling pads included.

Size: 28" x 18" x 10".

E

9985-1009004

NEW



9985-1009004 with Electronics

9985-1005753 without Electronics



9985-1005725

CPR Torso

This lightweight and easy to transport torso features:

- Airway ball valve which allows the lungs to inflate only if the head is extended and accurately positioned
- Lifelike anatomical landmarks such as carotid pulse, sternum, ribcage and sub-sternal notch
- Easy to replace mouth / nose pieces
- Soft carrying case with kneeling pads

70x43x22 cm; 7.0 kg

E

9985-1005725



9985-1005726

CPR Torso with Light Controller

Light controller which confirms correct hand placement, ventilation volume and compression depth.

All other features like 9985-1005725.

9985-1005726

Options and Replacements for 9985-1005725/9985-1005726

Mouth/Nose Pieces,
(pkg. of 10)

9985-1005741

Airway Systems,
(pkg. of 10)

9985-1005742

Options and Replacements for 9985-1005635 – 9985-1005637

Lung/Mouth Protection Bags,
(pkg. of 100)

9985-1005638

Carry Bag

Holds 5 fully assembled Low Budget CPR Torsos.

9985-1005639



9985-1005635 –
9985-1005637



Low Budget CPR Torso

An inexpensive manikin designed for teaching individuals or large groups the life-saving techniques of CPR.

The one-piece, disposable lung /mouth protection bags make this manikin completely sanitary. The airway opens using the head tilt /chin lift method and there is a visible chest rise when ventilated. The xiphoid process provides an anatomical reference point for hand placement and compressions. The manikin also features both adult and child capabilities.

Comes with 10 lung mouth protection bags.

E

9985-1005637

Low Budget CPR Torso, 10-Pack

The pack includes 10 manikins, 100 lung /mouth protection bags and 2 carrying bags.

All other features same as 9985-1005637.

9985-1005635

Low Budget CPR Torso, 5-Pack

The pack includes 5 manikins, 50 lung /mouth protection bags and 1 carrying bag.

All other features same as 9985-1005637.

9985-1005636

CPR Torso with Light Controller

This easy to transport torso allows the practice of adult CPR techniques. Optionally child CPR can also be practiced by changing the supplied springs inside the torso. Individual student face masks with a one way non rebreathing valve and disposable airways provide maximum protection against cross contamination. Supplied with a washable jogging suit, child springs, 10 disposable lower airways, 10 disposable tracheal airways, five sanitary face masks and a carrying case. Features include:

- Palpable anatomical landmarks (xiphoid, navel, nipples and rib cage)
- Adult CPR training with optional child springs
- Fully articulated head, neck and jaw
- Palpable carotid pulse

The light controller allows the following CPR evaluation:

- Adult/child mode
- Proper compression depth (yellow light)
- Proper ventilation volume (green light)
- Improper hand placement (red light)

Includes 4 "D" batteries.
48.5x30.5x80 cm; 17.0 kg

E

9985-1005618



Adult



CPR Manikin with Printer Unit

This full size manikin allows the practice of adult CPR techniques. Same features as 9985-1005618 (see page 152). The printer unit allows CPR evaluation. The performance of each skill is displayed separately while averages are stored in the memory. Compression and ventilation waveforms are plotted in a time sequence. Averages are shown on the display and printed on paper. (4 pens, 3 rolls of paper and 6 "D" batteries are included).

Evaluation includes:

- Adult/child mode
- Compression rate
- Proper compression depth (yellow light)
- Ventilation duration
- Proper ventilation volume (green light)
- Incorrect hand placement (red light)

91.5x53.5x33 cm; 31.0 kg

E

9985-1005617

CPR Black Manikin with Memory and Printer

All other features same as 9985-1005617.

9985-1005694

CPR Manikin with Memory Unit

All other features as 9985-1005617, without printer unit.

91.5x53.5x33 cm; 31.0 kg

E

9985-1005584

CPR Black Manikin with Memory (not shown)

All other features as 9985-1005584.

9985-1005695

Replacements for
9985-1005584, 9985-
1005617, 9985-1005618

Sanitary Face Masks,
(pkg. of 25)

9985-1005600

Tracheal Airways,
(pkg. of 10)

9985-1005601

Lower Airways,
(pkg. of 10)

9985-1005602

Resuscitation Basic Techniques

Options and Replacements for 9985-1005819

Disposable Airways, (pkg. of 10)

9985-1005820

CPR Computer Link

This link connects your CPR Simulators (if given as an option) and any computer having Windows 98 or WinXP. The interactive software features color graphics for CPR teaching and testing stations for either adult, infant or newborn mode. Cardiac compression and airway ventilation waveforms can be monitored, saved and printed. Supplied with carrying bag.

E

9985-1005822

CPR Monitor

Displays cadence and depth of cardiac compression and airway ventilation.

9985-1005800



9985-1005822

Adult CPR Torso

Torso with fully articulating head, neck, and jaw permitting head tilt, chin lift, jaw thrust, and neck extension. Features include:

- Easily accessible chest cavity with ribcage, lungs, and heart for realism and practice of the Heimlich manoeuvre
- Airway block when head is forward
- Realistic chest rise
- Carotid arterial pulse points
- Eyes open and close; one pupil is dilated

Supplied with 10 disposable airways and carrying case.

E

9985-1005819



9985-1005819

Adult CPR Manikin with Light Controller

This full size manikin allows the training of BLS like rescue techniques and CPR. The resiliency and weight of the body is very realistic.

Features include:

- Natural resistance to chest compression
- Palpable carotid pulse
- Anatomical landmarks such as sternum, ribcage and sub-sternal notch
- Airway ball valve which allows the lungs to inflate only if the head is extended and accurately positioned
- Light controller which confirms correct hand placement, ventilation volume and compression depth

167 cm; 19.0 kg

E

9985-1005738



9985-1005738

Options and Replacements for 9985-1005738

Mouth/Nose Pieces, (pkg. of 10)

9985-1005741

Airway Systems, (pkg. of 10)

9985-1005747

Carrying Bag for 167 cm Adult Manikin

9985-1005748

I.v. Lower Arm with Hand

An economic option to train i.v. injection. Made of durable material for repeated use.

Features include:

- Palpable veins, lifelike vein roll-over
- Suitable for blood sampling or fluid injection
- Supplied with artificial blood

9985-1005749

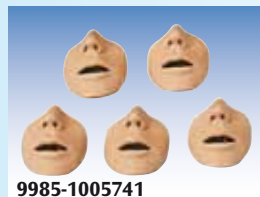

9985-1005741

Trauma Moulage Kit

The kit contains a big variety of bleeding and non-bleeding wounds.

A perfect kit to be added to a manikin. Bleeding wounds (complete with reservoir bags with pump assembly):

- 1 sucking wound of chest
- 1 laceration of the forearm
- 1 broken clavicle with seat belt contusion
- 1 projectile entry & exit of arm
- 1 impalement of lower leg
- 1 crushed foot
- 1 jaw wound (manikin use only)
- 1 laceration of the forehead (manikin use only)
- 1 compound fracture of humerus
- 1 compound fracture of femur
- 1 compound fracture of tibia
- 1 abdominal wound with protruding intestines
- 1 pkg. blood powder for 4.5 litre simulated blood

Non-bleeding wounds:

- Burn of the chest, burn of the back, burn of the hand and 2nd and 3rd degree burn of the forearm
- 1 burn of face (manikin use only)

E

9985-1005712

STAT Baby – Training for Life

Realism in paediatric training no longer crawls at old technology rates. STAT Baby brings you the most lifelike simulator for infant care by utilizing new materials for tactile awareness during patient assessment. Developed in conjunction with leading paediatric physician involvement, this baby contains a wide range of skill sets in a simple format that is affordable to all. It has the size of a nine month old baby, weighs 7 kg and has the following characteristics:

- IO leg
- Peripheral IV (left hand and foot)
- IM left deltoid and thigh and SC injection sites
- PICC line
- ET tube insertion
- Laryngeal spasm
- Tongue oedema
- LMA insertion
- Trach care
- NG tube placement with fluid reservoir
- Feeding tube care
- Rectal medication
- Pulses (6 pulse locations – 2 brachial, 2 femoral, 2 carotid)
- Defib (shock level 2-4 joules per kg)
- Foley cath insertion (female manikin)
- Pneumothorax

The Stat Baby is supplied with accessories that include IV vein kit (1 arm and 1 leg), leg skin (1), arm skin (1), IO leg bones (12), pneumothorax sites (4), injection site (2), Picc line site (1), reservoir bag (4), defibrillator adapters, ECG interactive simulator, and simulated blood powder (1).

91x36x23 cm; 9 kg

E

9985-1005779



9985-1005779



9985-1005102

Intubation Head

This model is especially designed to instruct and practice endotracheal intubation. The accurately modelled life size head allows the correct depth, angle, and pressure of insertion of a laryngoscope to be taught. Mounted on base.

Delivered without laryngoscope.

21x16x17.5 cm; 0.6 kg

E

9985-1005102



9985-1005698

Advanced Child Airway Management Trainer

Present your students with the challenges they may face in the real world. Advanced Child Airway Management Trainers offer tongue swelling and laryngospasm. This advanced airway management trainer is perfect for practicing skills on paediatric patients and represents the size of an 8-year-old patient. Practice intubation, ventilation, suction, and jaw thrust techniques. Realistic anatomy and landmarks include teeth, tongue, oral and nasal pharynx, larynx, epiglottis, arytenoids, false and true vocal cords, trachea, lungs, oesophagus, and stomach. The trainer allows you to practice oral, digital, and nasal intubation, as well as E.T. (Endotracheal Tube), E.O.A. (Oesophageal Obturator Airway), P.T.L. (Pharyngeal Tracheal Lumen), L.M.A. (Laryngeal Mask Airway), E.G.T.A. (Oesophageal Gastric Tube Airway), and Combitube® insertion. Separate lungs for auscultation. Inflatable stomach bladder indicates oesophageal insufflation. With its slightly anterior position, swelling tongue, and vocal cords, the Advanced Child Airway Management Trainer is a great trainer for introductory as well as advanced training. Includes training stand to mount head, pump spray lubricant, and hard carrying case.

E/D/F/S/I/NL

9985-1005698



9985-1005200

PALS Baby with ECG-Simulator

Simulates a 3 month old infant and allows realistic training of skills required for ACLS of infants including:

- CPR (Ventilation via bag-valve-mask)
- Endotracheal and nasotracheal intubation
- Practice of Sellick maneuver
- Auscultation of breath sounds
- Bilateral chest movement and stomach distension
- Oral/Nasal Airways
- Oral/Nasal Gastric Tube Insertion
- Intravenous access via scalp vein
- ECG monitoring (with 4 lead ECG) and arrhythmia recognition
- Simulated pulse

„Heartsim 200“ ECG Rhythm Simulator provides basic, modified and paediatric rhythms with variable pulse rate and strength.

- Features:
- A total of 30 rhythms
 - 17 modified rhythms including Torsade de Pointes
 - 7 paediatric rhythms
 - Battery powered

54x35x14 cm; 2.2 kg

E/D/F/S/I/NL

9985-1005200

Options and Replacements for 9985-1005200

Intraosseous Leg

Allows intraosseous needle insertion with aspiration of simulated bone marrow or injection of drugs. Supplied with 5 intraosseous pads.

9985-1005201

Intraosseous Pads, 5 pieces

9985-1005202



9985-1005658

PALS Manikin

This dramatic, state of the art training manikin is a complete resuscitation system designed for teaching life saving techniques for infants. Ideal for paediatric advanced life support, nursing, hospital, paramedic, and EMT training at every level. Tactile and visual realism combine to provide students with the most realistic training possible. The Manikin allows practice of 4-lead ECG monitoring, IV therapy, umbilical catheterization, airway management, intraosseous infusion, and CPR! The unique chest skin with an umbilical cord allows practice of proper techniques in umbilical catheterization, including cutting and clamping. Fluid may be aspirated through the umbilicus, making this training manikin incredibly lifelike. An IV arm and leg allow for realistic practice of paediatric venipuncture. The cephalic and basilic veins are accessible on the IV arm, as well as the dorsal venous arch on the hand; the great saphenous veins are accessible on the IV leg, as well as the dorsal venous arch on the foot. An intraosseous infusion leg demonstrates and simulates the intraosseous infusion procedure. Featuring realistic anatomy and size, the airway management head is ideal for practicing airway management skills on an infant. Includes a hard carrying/storage case. Three-year warranty.

Procedures That Can Be Performed:

- CPR:** Palpable and visual landmarks; fully articulated head, neck, and jaw.
- Airway Management:** Realistic anatomy of the mouth, tongue, oral pharynx, larynx, epiglottis, vocal cords, trachea, and oesophagus; oral and digital intubation capabilities; suctioning capabilities.
- IV Arm & Leg:** Smaller lumen tubing simulates the size of an infant's veins; realistic flashback from a pressurized system; replaceable skin and veins.
- ECG/Umbilical Cannulation Skin:** Arrhythmia recognition; learn proper techniques in umbilical catheterization; allows practice of umbilical cannulation, cutting, and clamping; aspirate fluid through the umbilicus
- Intraosseous Infusion:** Palpable landmarks include the patella, tibia, and tibial tuberosity; replaceable bones and skin; pressurized system allows aspiration of fluid.

61x42x19 cm; 8.6 kg

E

9985-1005658

PALS Manikin with ECG-Simulator

This trainer of a female infant allows the practicing of a wide range of paediatric ALS techniques. Features include:

- Bag valve mask ventilation
 - Oral and nasal intubation including Sellick's manoeuvre
 - Placing of NG tube
 - Three lead ECG monitoring (16 different arrhythmias with adjustable heart rate)
 - Palpation of brachial pulse
 - External chest compressions
 - Movable jaw
 - I.v sites in hand and arm for blood sampling or fluid injection
 - Intraosseous needle insertion and aspiration of bone marrow in both legs
 - Palpation of scalp vein, cranial sutures and fontanelles
- Supplied with carrying bag.

57 cm; 1.6 kg

E

9985-1005759

Options and Replacements for 9985-1005658

ECG Simulator

With this unit various ECG rhythms can be generated and displayed on an ECG monitor (not included) for diagnostic training. All arrhythmias can be displayed in adult or paediatric mode so that a total of 34 rhythms are available. The unit can be used to upgrade 9985-1005658 and also works separately to practice operating a defibrillator/ external pacer. Simply connect a defibrillator/external pacer to the simulator, defibrillate/pace directly into the simulator and observe ECG rhythms.

- The following 6 different arrhythmias are available for pacer training: Sinus Brady, Junctional Brady, 2nd degree type I A-V block, 2nd degree type II A-V block, 2nd degree type II A-V block with PVCs and 3rd degree A-V block.
- Cardioversion can be simulated by defibrillating the manikin with a manual, semi-automatic, or automatic defibrillator.
- The following 11 arrhythmias are available for defibrillator training: V. Fib, V. Tach (fast), V. Tach (slow), V. Tach (polymorphic), A. Fib, A. Flutter, SVT, Sinus Tach, Sinus rhythm with PVCs, Asystole and NSR.
- An LED illuminates for: pacer pulse detection, defibrillator discharge detection, adult mode, paediatric mode and low battery. Battery saver feature powers-off simulator automatically when not in use.

9985-1005666

Options and Replacements for 9985-1005658

Art. Nr.	Description
9985-1005659	4 Intraosseous Leg Skins 10 Leg Bones
9985-1005660	Intraosseous Infusion Needle (15 gauge)
9985-1005661	I. v. Leg Skin & Veins
9985-1005662	I. v. Arm Skin & Veins
9985-1005663	10 Umbilical Cords
9985-1005664	6 Umbilical Clamps

Options and Replacements for 9985-1005759

Art. Nr.	Description
9985-1005760	12 Intraosseous Bones with Blood Capsules
9985-1005761	4 Leg Skins
9985-1005762	2 Arm/Hand Skins
9985-1005763	Arm/Hand Vein Set
9985-1005764	4 Lungs/Stomachs



9985-1005759

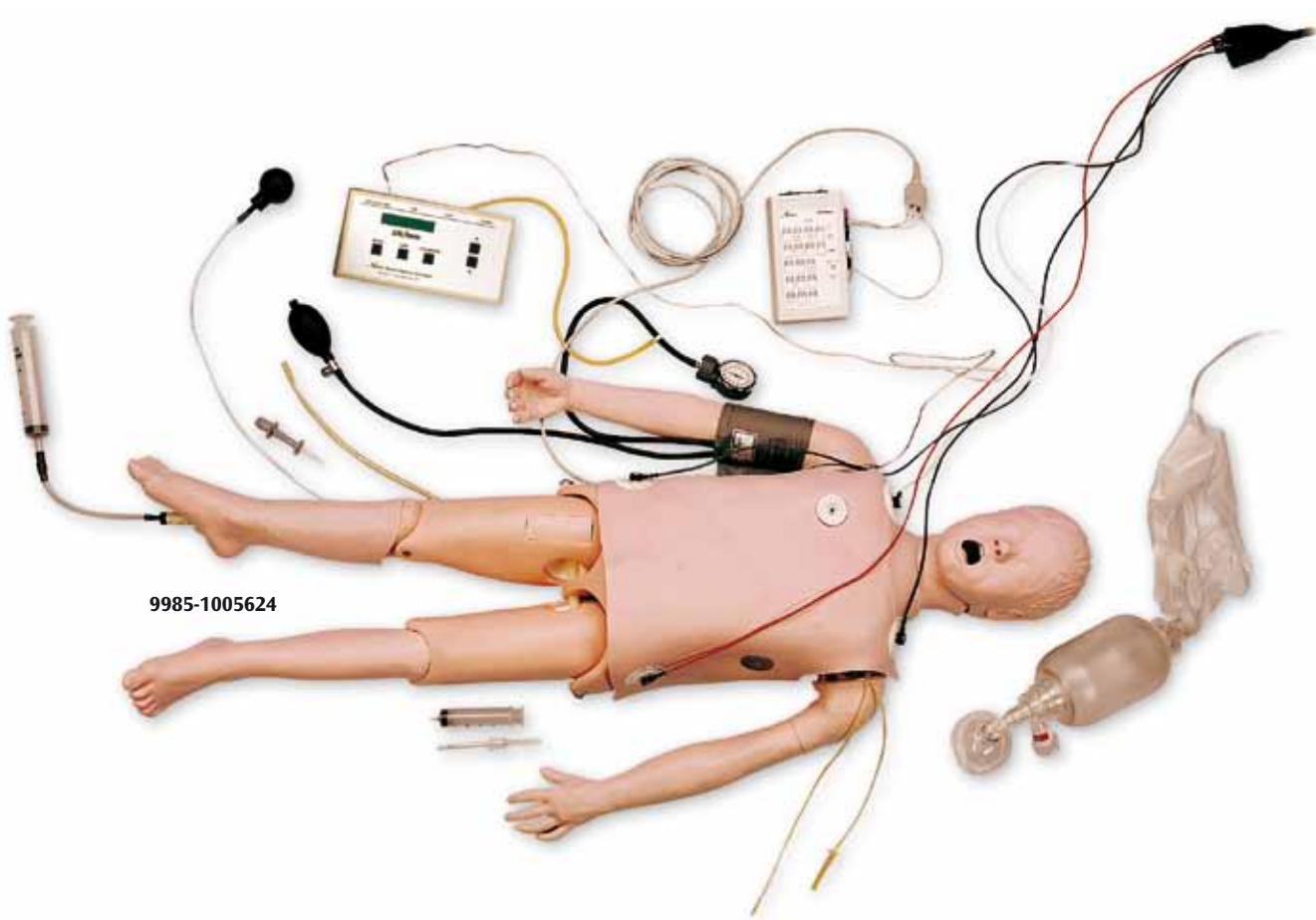

9985-1005624

Child ACLS Manikin with Interactive Arrhythmia Simulator

This full body manikin of a 5 year old child offers a wide range of ACLS training:

CPR

- Palpable and visual landmarks
- Fully articulated head, neck and jaw

Airway Management

- Realistic anatomy of the mouth, tongue, oral pharynx, larynx, epiglottis, vocal cords, trachea and oesophagus
- Separate left and right lungs for auscultation
- Suctioning capabilities
- Oral, nasal and digital intubation capabilities
- Inflatable stomach bladder to indicate oesophageal intubation

I.v. Injection (at arm)

- Realistic size of a child's veins
- Articulated at the biceps for antecubital and dorsal access
- Realistic flashback from a pressurized system

Blood Pressure Measurement

- Instructor determines systolic and diastolic levels, heart rate and sound volume
- Speaker in arm reproduces real blood pressure sounds
- 5 Korotkoff phases can be turned on and off
- Auscultatory gap can be turned on and off

Intraosseous Infusion

- Palpable landmarks include the patella, tibia and tibial tuberosity
- Pressurized system allows aspiration of fluid

Femoral Access

- Palpable arterial pulse
- Palpable symphysis pubis and anterior superior iliac spine
- Realistic flashback from a pressurized system

Defibrillation Chest

- Internal load box absorbs full strength of every shock
- Manual, semi-automatic, automatic defibrillation
- Monitor manikin like a real patient at 4 ECG sites and 2 defibrillation sites
- Compatible with all standard brands and types of defibrillators and ECG-monitors

Interactive ECG-Simulator

This external unit allows defibrillator and pacer training directly on the manikin. Training without a manikin is also possible. Various ECG rhythms can be generated and displayed on an ECG-monitor (not included) for diagnostic and defibrillation training. All arrhythmias can be displayed in adult or paediatric mode so that a total of 34 rhythms are available.

- The following 6 different arrhythmias are available for pacer training: Sinus Brady, Junctional Brady, 2nd degree type I A-V block, 2nd degree type II A-V block, 2nd degree type II A-V block with PVCs and 3rd degree A-V block.
- Cardioversion can be simulated by defibrillating the manikin with a manual, semi automatic, or automatic defibrillator. The following 11 arrhythmias are available for defibrillator training: V. Fib, V. Tach (fast), V. Tach (slow), V. Tach (polymorphic), A. Fib, A. Flutter, SVT, Sinus Tach, Sinus rhythm with PVCs, Asystole and NSR.
- An LED illuminates for: pacer pulse detection, defibrillator discharge detection, adult mode, paediatric mode and low battery. Battery saver feature powers-off simulator automatically when not in use.

119 cm; 9 kg

E

9985-1005624

Options and Replacements for 9985-1005624

Lungs

9985-1005652

Stomach

9985-1005653

Skin and Veins

9985-1005654

Intraosseous Leg Bones,

(pkg. of 10)

9985-1005655

Intraosseous Leg Skins,

(pkg. of 2)

9985-1005656

Femoral Injection Pad

9985-1005657



9985-1005821

Child Interactive PALS Manikin with Laptop Computer / Child 5 Years Old

Sensor equipped manikin of a 5 year old child with intubatable airway, i.v. injection arm and iv./i.o. injection leg. 15 heart rates and 9 breath sounds can be checked. Virtual instruments allow the trainee to monitor and treat the manikin (linked by an Interface). An instructor driven interactive system (CodeMaker) with teaching stations according to AHA (American Heart Association) resuscitation guidelines. Featuring colour graphics it allows the instructor to choose from 10 pre-programmed codes or to define thousands of testing experiences (may be stored, resumed or printed) such as

- Cardioversion
- Arrhythmia detection and treatment
- Assessment of vital signs using blood pressure/pulse oximeter
- Selection of medication

Sensors confirm if the following procedures have been done correctly:

- Placement of ET-tube
- Airway ventilation
- Chest compression
- Placement of i.v. needle (antecubital region, femoral vein) and i.o. needle (tibia)
- Placement of ECG leads
- Placement of blood pressure cuff and finger cuff
- Placement of defibrillator pads and external cardiac pacer

Supplied with Multimedia laptop computer and carrying bags.

E

9985-1005821

MegaCode Kelly

Realistic Life Support Training Made Easy

The MegaCode Kelly VitalSim™ with the advantages of the new VitalSim™ electronics is an excellent trainer for Advanced Life Support. The following measures can be trained:

- Intubation (oral and nasal) with obstructed airways
- Oropharyngeal and nasopharyngeal airway access
- Fibroptic and lightwand intubation
- Retrograde intubation
- Needle and surgical cricothyroidotomy
- Auscultation of the stomach
- Chest decompression (midclavicular and midaxillary)
- Blood pressure measurements on movable arm
- Bilateral palpation of carotid pulse
- Peripheral IV training

Supplied with: full body model, 6 neck skins, 1 roll of cricothyroid tape, lubricant, jacket, pants, carrying case, instructions

E

Please note that VitalSim™ has to be ordered separately!

MegaCode Kelly Advanced (VitalSim™-Capable)

9985-1005257

MegaCode Kelly VitalSim™ Basic (ECG Only)

9985-1005260



9985-1005213

VitalSim™

Using the customisable wireless or hand held wired remote, the VitalSim™ control unit works with VitalSim™ capable manikins and task trainers to simulate ECG, sounds, blood pressure and pulses (see page 106).

9985-1005213

Arterial Stick Arm (see page 131)

Infusible arteries designed for training the proper arterial puncture procedure for blood gas analysis

9985-1005276



9985-1005257/
9985-1005260



9985-1005649

Adult

Adult ACLS Manikin with Interactive Arrhythmia Simulator

This full body manikin offers a wide range of ACLS training possibilities including arrhythmia recognition and confirmable defibrillation. The manikin is supplied with a storage case and allows training of the following ACLS procedures:

CPR

- Palpable and visual landmarks
- Fully articulated head, neck and jaw
- A printer unit allows CPR evaluation (adult/child mode, confirmation of proper hand placement, shows compression rate and depth plus ventilation duration and volume)

Airway Management

- Realistic anatomy of the mouth, tongue, oral pharynx, larynx, epiglottis, vocal cords, trachea and oesophagus
- Cricoid cartilage allows for practice of Sellick manoeuvre
- Separate left and right lungs for auscultation
- Suctioning capabilities
- Oral, nasal and digital intubation capabilities

I.v. and I.m. Injection (arm)

- Articulated at the biceps for antecubital and dorsal access
- Bony landmark at shoulder to identify muscle tissue for i.m. injections
- Realistic flashback from a pressurized system

Blood Pressure Measurement

- Instructor determines systolic and diastolic levels, heart rate and sound volume
- Speaker in arm reproduces real blood pressure sounds
- 5 Korotkoff phases can be turned on and off
- Auscultatory gap can be turned on and off

Defibrillation Chest

- Internal load box absorbs full strength of every shock
- Manual, semi-automatic, automatic defibrillation
- Monitor manikin like a real patient at 4 ECG sites and 2 defibrillation sites
- Compatible with all standard brands and types of defibrillators and ECG-monitors

E

9985-1005649

Interactive ECG-Simulator

See 9985-1005624, page 157.

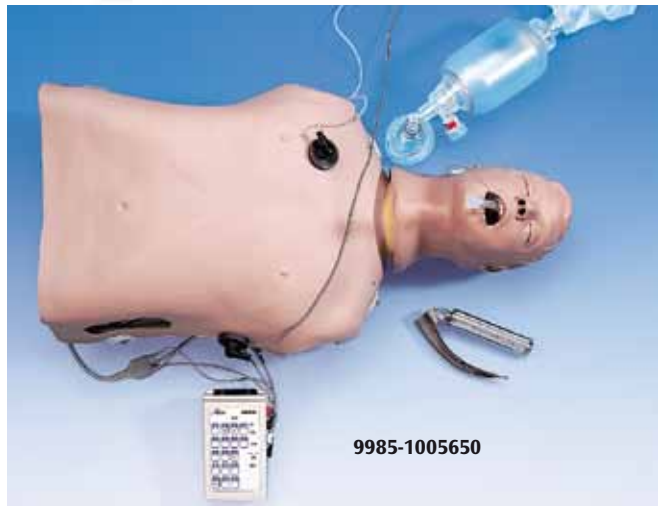

9985-1005650

Adult ACLS Torso with Interactive Arrhythmia Simulator

This easy to transport torso allows training for the same procedures as 9985-1005649, but without blood pressure measurement, i.v. and i.m. injection (at arm), storage case and without printer unit. Ventilation bag, laryngoscope, tube and electrodes are not included in scope of delivery.

E

9985-1005650

Options and Replacements for 9985-1005649 / 9985-1005650

Lungs

9985-1005607

Stomach

9985-1005608

Skin and Veins

(9985-1005649)

9985-1005647

Storage Case for ACLS Torso

(9985-1005650)

9985-1005651

Resuscitation Advanced Techniques



9985-1005180

Mini Cricotracheotomy Trainer Individual

The main benefit of this trainer is the low running cost. Use of a simple disposable trachea transforms the trainer into a very effective low cost system.

18x16x10.5 cm; 0.56 kg

E



9985-1005184

9985-1005184

Mini Cricotracheotomy Trainer 4-Packs

All other features like 9985-1005184.

9985-1005185

Cricotracheotomy Trainer

For advanced Trauma Life Support courses.

An innovative non biological trainer is the Cricotracheotomy Trainer that simulates the laryngeal body tissue. Use of a simple disposable trachea transforms the trainer into a very effective low cost system. Up to 18 Tracheostomies or 36 Cricothyroidostomies can be performed on a single component. Palpable anatomical presence is achieved with comparatively easy identification of the cricothyroid cartilage and the thyroid cartilage. Responsive incision making. Effective alternative to use of animal tissue. Supported in a strong and immoveable base. Scalpel is not included in scope of delivery.

45x15x36 cm; 3.0 kg

E

9985-1005180

Replacements for 9985-1005180

Art. Nr.	Description
9985-1005181	Trauma Kit (2 Tracheas and 4 Sheets of Skin) 19x15x5 cm; 0.6 kg
9985-1005182	Cricotracheotomy Tracheal Rings 9.5x5x5.5 cm; 0.08 kg
9985-1005183	Cricotracheotomy Neck Muscle 12x8x7 cm; 0.3 kg

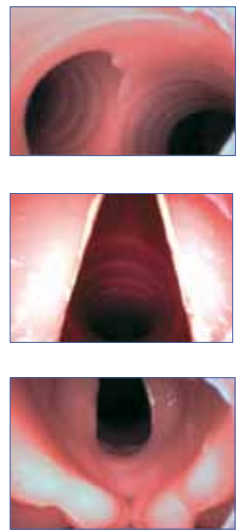

9985-1005325

Intubation Trainer™

The Intubation Trainer™ is the ideal tool for physicians, paramedics, nurses, lung specialists and other medical professionals to train endotracheal intubations. The product comes with a standard USB port and is compatible with the operating systems Windows 98, 2000, ME and XP. Benefits of the Intubation Trainer™:

- See and understand the anatomy of the upper airways
- Learn the correct positioning of the tube in the trachea and correct handling of the laryngoscope
- Real-time feedback of eye-hand coordination
- Procedure recording capability improves inclusion of the whole study group during a session

The Intubation Trainer™ can be used with our following models: 9985-1005396, 9985-1005649, 9985-1005633, 9985-1005214, 9985-1005827
Supplied with: case, software, driver, instructions, camera.

E

9985-1005325



9985-1003657

9985-1003659

Emergency Laryngoscope

- Fibre optic handle for two C batteries (2.5 V Halogen)
 - Mac 3a blade made of special plastic
 - Robust and unbreakable
 - Exceptional strength with low weight
 - Patient friendly with reduced risk of injury or damage of teeth
 - Blade does not “freeze” at low temperatures
- Supplied with zipper pouch.
19x11x4 cm; 0.26 kg

9985-1003657

Deluxe Laryngoscope

- Fibre optic handle for two C batteries (2.5 V Halogen)
 - Mac 3 fibre optic blade
 - Modular construction – swap modules in a few seconds
 - Ideal Mac shape with no light pipe in the line of sight
 - Blade module made entirely of stainless steel
 - Bright white light from 3.5 mm F.O. bundle
- Supplied with zipper pouch.
19x11x4; 0.26 kg

9985-1003659

Options and Replacements for 9985-1003657 / 9985-1003659

Art. Nr.	Description
9985-1003658	6 Halogen Bulbs 2.5 V

9985-1005396



Endotracheal Intubation Simulator

This intubation simulator provides exceptionally good and realistic intubation training, enabling you to:

- Acquire both the skill of oral and nasal tracheal intubation
- Acquire the skill of handling supraglottic airway devices (e.g. laryngeal mask airway, oesophageal gastric tube airway)
- Confirm left and right air sound with a stethoscope
- Neck flexion and head extension
- Advancement of the mandible

Tongue, epiglottis and pharynx are reproduced realistically, with the tongue and mouth made of soft material. The front teeth (upper four) are made to break when pressure is exerted incorrectly and the teeth are used as a fulcrum while using a laryngoscope. Determining incorrect intubation is possible! When intubation and ventilation were carried out correctly, this is shown by simultaneous rising of the left and right chest. When only one lung is ventilated, the error is shown in that only one side will rise. When the tracheal tube has been mistakenly intubated into the oesophagus and air is sent, the abdomen will rise (stomach inflation), making it possible to determine the error. Parts of the model are purposefully made to be damaged if handled roughly. Accessories: 3 teeth, silicone oil, carrying case. Ventilation bag, tube, stethoscope and laryngoscope are not included in scope of delivery.

75x45x24 cm; 6.2 kg

E

9985-1005396

Options and Replacements for 9985-1005396

Art. Nr.	Description
9985-1005397	Front Teeth, set of 3
9985-1005399	Synthetic Skin for the Body (skin-coloured)
9985-1005400	Lubricant (silicon oil)

Intubation Head

This trainer simulates a non-anaesthetized patient and features anatomical landmarks such as: teeth, tongue, oral and nasal pharynx, larynx, epiglottis, arytenoids, false cords, true vocal cords, trachea, lungs, oesophagus, cricoid cartilage and stomach. Supplied with stand, pump spray lubricant and hard carrying case.

The following airway management procedures can be trained:

- Intubation (oral, digital and nasal)
- E.T. (Endotracheal Training)
- E.O.A. (Oesophageal Oral Airway)
- P.T.L. (Pharyngeal Tracheal Lumen)
- Combitube® insertion
- Ventilation and suction techniques
- Proper cuff inflation
- Sellick manoeuvre (applying cricoid pressure changes the position of the trachea and closes the oesophagus)

63x30.5x40.6 cm; 15 kg

E

9985-1005633

Options and Replacements for 9985-1005633

Art. Nr.	Description
9985-1005607	Lungs
9985-1005608	Stomach



9985-1005396

Adult

Airway Management Trainer

Realistic practice is the key to developing proficiency in airway management skills. The Airway Management Trainer's lifelike upper torso and head simulates real world complications when practising a variety of intubation, ventilation and suction techniques.

- Realistic anatomical features allow demonstration of Sellick Manoeuvre and laryngospasm
- Practical training in clearing an obstructed airway and suctioning of liquid foreign matter
- Provides visual inspection of lung expansion and auscultation of breath sounds
- Simulates stomach inflation and vomiting situation
- Airway demonstration model is standard with each trainer
- Can be used with trachlight products
- Improved airway allows insertion of laryngeal mask airway and combi-tube

Includes: Manikin on sturdy board, airway demonstration model, cleaning kit, lubricant, carry case, and directions for use.

75x27x45 cm; 15 kg

E/D/F/S/J/SE/FIN

9985-1005214

Replacements for 9985-1005214

Art. Nr.	Description	Dimensions/Weight
9985-1005215	Airway Demonstration Model	20x10x10 cm; 0.22 kg
9985-1005216	Concentrated Simulated Vomit	8x2x2 cm; 0.01 kg
9985-1005217	Airway Lubricant	23x18x16 cm; 3.5 kg



9985-1005214



9985-1005633



9985-1005827

Intubation Torso

This upper torso features:

- Realistic chest cavity with trachea, bronchi and lungs, heart and stomach
- Nominal 18 mm airway
- Anatomically accurate mouth, tongue, airway and oesophagus
- Fully articulating head, neck and jaw
- Wide, straight, stiffer epiglottis and realistic vocal cords
- Soft neck with cricocartilage

The following airway management procedures can be performed:

- Head tilt/chin lift, jaw thrust and neck extension into the sniffing position
- Placement of cuffed ET tubes and EOA (Oesophagus Obturator Airway)
- Intubation (oral, digital, nasal)
- Sellick manoeuvre
- Observation of unilateral or bilateral lung expansion under positive pressure ventilation
- Surgical placement of tracheotomy tube
- Emergency needle cricothyrotomy stick
- Bilateral tension pneumothorax decompression

Supplied with 6 neck collars, 3 cricocartilages, membrane tape and carrying bag. Laryngoscope and tube are not included in scope of delivery. 76x56x30.5 cm; 11.4 kg

E

9985-1005827

Pneumothorax Training Manikin

Recommended by EMT (Emergency Medical Training) instructors, this model permits instruction of the delicate procedure for successfully managing chest wounds in which a collapsed lung interferes with the victim's respiration and blood flow. The model accepts needle and thoracotomy in the second intercostal space, in the mid-clavicular line, the fifth intercostal space in the mid-axillary line. A realistic training aid to practice proper needle insertion which enables built-up air pressure to escape the thorax. Delivered with foot pump, replacement pleural cavity and carrying bag, without procedural needle.

23x48.5x48.5 cm; 3.6 kg

E

9985-1005713

Options and Replacements for 9985-1005713

Skin	Pleural Cavity
9985-1005736	9985-1005737



9985-1005780

9985-1005774



Economy Adult Airway Management Trainer

This detailed adult intubation head comes mounted for clinical teaching and practice of advanced airway management. Intubation procedures and skills, including anatomy knowledge and recognition, endotracheal intubation, nasotracheal intubation, use of field emergency airway adjunct tubes like LMAs and Combitube, securing, and suctioning, and maintenance of the installation can all be practiced with this unit. A soft carry bag, lubricant, and instructions for use are included. Without tube.

53x23x25 cm; 4.5 kg

E

9985-1005780

Adult Airway Management Trainer

Detailed anatomy featured on the adult intubation trainer stands out. Get a clear picture of human anatomy from the sculpted alveolar sac, bronchial tree, and blood vessel structures of the cross sectioned and exposed flexible lungs, to the interior main bronchus and oral/nasal pharyngeal spaces. Combine these details with an airway complicated by breakout teeth, tongue oedema, and laryngo-spasm, and this airway trainer rates hard. An anatomical stomach that swells with oesophageal intubation, or excessive pressure with the BVM during rescue breathing, together with the vomiting capability of this manikin makes this an exceptional educational tool for multitasking. Includes instructions for use, soft carry bag, lubricant, and replaceable lungs and stomach.

84x64x30 cm; 20 kg

E

9985-1005774



9985-1005713

Water Rescue Manikin

This manikin allow Coast Guards, Lifeguard Trainers and Emergency Personnel to train water rescue and retrieval. When filled with water the manikins will sink to the bottom.

CPR Water Rescue Manikin (adult), 165 cm

This manikin of an adult allows Coast Guards, Lifeguard Trainers and Emergency Personnel to teach water rescue and retrieval as well as CPR. The manikin has articulated joints and is made of durable plastic and rust resistant steel. When filled with water the manikin will submerge to the neck, if an additional 5 kg (a brick will do) is added, it will sink completely.

19 kg

E

9985-1005767



9985-1005767

Newborn Water Rescue Manikin

Filled with water this manikin has a weight of 3.2 kg

E

9985-1005699

Child Water Rescue Manikin (3 years old)

Filled with water this manikin has a weight of 9 kg

E

9985-1005739

Options and Replacements for 9985-1005767

Airway Systems,
(pkg. of 24)

9985-1005765

Mouth / Nose Pieces,
(pkg. of 10)

9985-1005741



9985-1005699

9985-1005739

Rescue Manikins

Rescue Manikins

These manikins allow training in the extrication of a person from a pole top situation, confined spaces, collapsed buildings, smoky rooms and also ladder carry-down protocols. A perfect aid in situations too hazardous or uncomfortable for human volunteers and especially suitable for Military, Fire Departments, Police Departments, Safety Teams and Emergency Personnel. The manikins feature articulated joints and realistic weight distribution. They are made of durable plastic with strong plastic-coated cables. These manikins are not fire resistant and are not for water rescue.

E

9985-1005768,
9985-1005769

Rescue Manikin 167 cm
25 kg

9985-1005700

Rescue Manikin 167 cm
75 kg

9985-1005703

Rescue Manikin 182 cm
66 kg

9985-1005768

Rescue Manikin 167 cm
48 kg

9985-1005701

Rescue Manikin 121 cm
7.25 kg

9985-1005704

Rescue Manikin 182 cm
75 kg

9985-1005769

Rescue Manikin 167 cm
66 kg

9985-1005702

9985-1005700,
9985-1005701,
9985-1005702,
9985-1005703

Options and Replacements for Rescue Manikins 121 cm/167 cm/182 cm

Art. Nr.	Description
9985-1005705	Weighted Vest 9 kg
9985-1005706	Weighted Vest 13.5 kg
9985-1005707	Weighted Vest 18 kg
9985-1005771	Carrying Bag for Rescue Manikin 121 cm
9985-1005748	Carrying Bag for Rescue Manikin 167 cm
9985-1005770	Carrying Bag for Rescue Manikin 182 cm



9985-1005705,
9985-1005706,
9985-1005707

Recovery & Accident Simulation

9985-1005708



Casualty Simulation Kit I

The most economical way to get started in simulated injuries. Reusable wounds and refillable accessories let you practice bandaging and splinting techniques repeatedly. The kit is supplied in a storage case and includes:

Bleeding wound (complete with reservoir bags with pump assembly):

- 1 compound fracture tibia

Non bleeding wounds:

- 12 assorted stick-on lacerations and open fracture wounds

Make-up Accessories:

1 atomizer mist sprayer; 1 bottle coagulant make-up blood; 1 pkg. blood powder for 4.5 litre simulated blood; 1 casualty simulation wax; 1 pkg. broken Plexiglas® for simulating glass imbedded wound; 4 grease paint colours: white, blue, brown and red; 1 pkg. methyl cellulose for blood thickening; 1 body adhesive for stick-on wounds; 3 spatulas; 3 tongue depressors
33x25.5x13 cm; 2.3 kg

E

9985-1005708

Casualty Simulation Kit III

This kit is especially suitable for use in the creation of a disaster scenario where application of make-up on multiple casualties creates the widest range of wounds. This kit contains specialty wounds associated with gunshots, like perforations, major avulsions and complex jaw wounds and also a large supply of makeup components. The kit is supplied in a storage case and includes:

Bleeding wounds (complete with reservoir bags with pump assembly):

- 2 compound fractures of humerus
- 2 compound fractures of tibia

Non bleeding wounds:

- 60 assorted stick-on lacerations and open fracture wounds

Make-up Accessories:

1 make-up palette; 1 scissors; 1 mirror; 1 measuring cup; 2 atomizer mist sprayer; 2 casualty simulation wax; 2 bottles coagulant make-up blood; 3 pkg. blood powder, each for 4.5 litre simulated blood; 2 pkg. broken Plexiglas® for simulating glass imbedded wound; 2 fake dirt; 2 each make-up Liners: red, blue, brown, white, yellow, black and flesh; 2 plasticine modelling paste: white and dark; 1 glycerine for simulating perspiration; 1 cold cream; 1 mineral oil; 1 charcoal; 3 latex compound to simulate scars; 2 petroleum jelly; 2 pressure sensitive tape; 1 pkg. methyl cellulose for blood thickening; 2 body adhesive for stick-on wounds; 6 spatulas; 10 tongue depressors; 10 cotton balls; 10 cotton applicators/swab sticks; 1 pkg. of tissues; 6 make-up sponges.
41x33x56 cm; 12.3 kg

E

9985-1005710

9985-1005709



Casualty Simulation Kit II

This kit gives you more complex wounds for testing higher levels of skill in bandaging and patient care while keeping initial expenditures low. The kit is supplied in a storage case and includes:

Bleeding wounds (complete with reservoir bags with pump assembly):

- 1 open amputation
- 1 compound fracture of humerus
- 1 compound fracture of tibia
- 1 sucking wound of chest
- 1 gunshot wound of palm

Non-bleeding wounds:

- 24 assorted stick-on lacerations and open fracture wounds

Make-up Accessories:

1 bottle coagulant make-up blood; 1 pkg. methyl cellulose for blood thickening; 3 pkg. blood powder, each for 4.5 litre simulated blood; 1 body adhesive for stick-on wounds; 1 casualty simulation wax; 1 pkg. broken Plexiglas® for simulating glass imbedded wound; 4 grease paint colours: white, blue, brown and red; 4 reservoir bags with pump assembly; 1 atomizer mist sprayer; 3 spatulas; 3 tongue depressors
25.5x23x46 cm; 4.1 kg

E

9985-1005709

9985-1005710



9985-1005711



Casualty Simulation Kit IV

This complex EMT (Emergency Medical Training) kit uses components applied to human and manikin patients to get the widest variety of training situations possible. Wounds strapped on, stuck on, created from wax and made to bleed challenge both the volunteer and the professional in areas of burns, lacerations, fractures of arms and legs and amputations; a good kit to simulate community disasters like bus accidents, or building explosions. The kit is supplied in a storage case and includes:

Bleeding wounds (complete with reservoir bags with pump assembly):

- 1 jaw wound
- 1 abdominal wound with protruding intestines
- 1 sucking wound of chest
- 2 compound fractures of humerus
- 2 compound fractures of femur
- 2 compound fractures of tibia
- 1 laceration of the forehead
- 1 open amputation
- 2 gunshot wound of palm

Non-bleeding wounds:

- 36 assorted stick-on lacerations and open fracture wounds
- 1 phosphorous burn of the hand
- 1 face in shock
- 2nd & 3rd degree burn of the face
- 2nd & 3rd degree burn of the chest
- 2nd & 3rd degree burn of the back
- 2nd & 3rd degree burn of the hand
- 2nd & 3rd degree burn of the forearm

Make-up Accessories:

1 mirror; 1 body adhesive for stick-on wounds; 2 casualty simulation wax; 3 bottles coagulant make-up blood; 5 pkg. blood powder, each for 4.5 litre simulated blood; 1 pkg. methyl cellulose for blood thickening; 4 grease paint colours: white, blue, brown and red; 2 pkg. broken Plexiglas® for simulating glass imbedded wound; 1 cold cream; 2 atomizer mist sprayer; 2 plasticine modelling paste: white and dark; 6 tongue depressors; 1 pkg. of tissues; 2 fake dirt; 1 charcoal; 1 petroleum jelly; 2 spatulas 61x23x46 cm; 14.6 kg

E

9985-1005711

Forensic Science Wound Package

These wounds are the special stick-on wounds found in the Forensic Science Wound Simulation Kit. You receive the 18 wounds developed for forensic science. Use these to augment your existing casualty simulation kit.

Wounds Included:

Petechiae; ecchymosis; pattern ligature; slash; shotgun close range; shotgun; intermediate range; intermediate range round; intermediate range flake; exit gunshot; contact gunshot contact handgun; contact wound; screwdriver; bite partial; bite complete; hesitation; single-edge knife; double-edge knife; blunt bat; bunny ears exit wound; exit wound ice pick. 36x25x15 cm; 5 kg

9985-1005781

9985-1005772



Forensic Science Wound Simulation Kit

This basic wound identification set was developed with the help of forensic experts and contains a number of injuries developed specifically for students to acquire proficiency in crime scene analysis and crime scene reconstruction. The details in the wounds are designed to determine type of weapon, direction of force, and other related details that only come with realistic trauma reproduction. This innovative kit contains carefully sculpted models of injuries taken from actual victim's wounds and reviewed by forensic education professionals ensuring real scene representations of trauma commonly found on violent crime victims.

This kit is a must for any applied program of wound study. Materials in this kit will provide first time exposure for the novice as well as continued training for the professional already in the field. From simple puncture wounds associated with sharp instrument trauma to firearms entry and exit wounds, this kit is critical in studying the methodology of crime scene reconstruction based on wound demographics. Can you recognize pattern ligature in strangulation? What was the murder weapon? What does a single bladed knife stab wound look like compared to a double edge wound? What are the difference between the wound of mechanism for suicide and hesitation marks? Each of these questions and more are addressed with a kit that also includes moulage wax, coagulant blood, and a selection of make-up for bruising, blanching and lividity. The entire case is packed in a sturdy carrying case for protection and ease of transportation to the training site. 24 different wounds in the kit; 72 pieces in all.

Wounds Included:

Petechiae; ecchymosis; pattern ligature; slash; shotgun close range; shotgun; intermediate range; intermediate range round; intermediate range flake; exit gunshot; contact gunshot contact handgun; contact wound; screwdriver; bite partial; bite complete; hesitation; single edge knife; double-edge knife; blunt bat; bunny ears exit wound; exit wound ice pick; compound fracture humerus; foreign body protrusion; large laceration; medium laceration large compound fracture; 2nd degree burn. 53x33x38 cm; 6 kg

9985-1005772

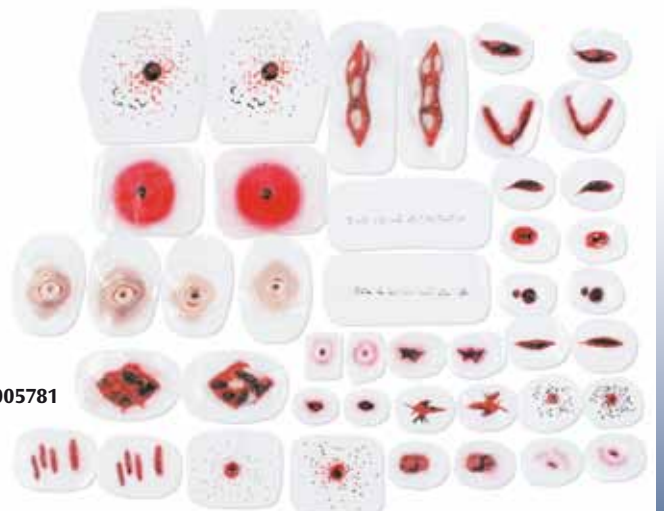

9985-1005781



9985-1004924

9985-1004924

9985-1004923

Female Acupuncture Model

- Made in China
 - approx. 50 cm tall
 - Chinese lettering
- With German and English descriptions

9985-1004924

Male Acupuncture Model Showing Muscles

- Made in China
 - approx. 50 cm tall
 - Chinese lettering
- With German and English descriptions

9985-1004925

Male Acupuncture Model

- Made in China
 - approx. 50 cm tall
 - Chinese lettering
- With German and English descriptions

9985-1004923



9985-1004930

9985-1004931

Acupuncture Model of the Hand

- Made in China
- Chinese lettering

9985-1004930

Acupuncture Model of the Foot

- Made in China
- Chinese lettering

9985-1004931

You will find our large selection of Charts starting on page 108.

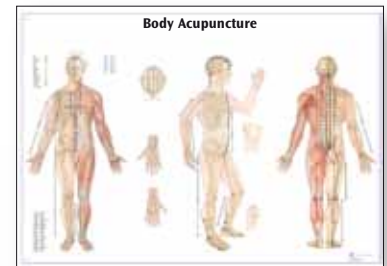

98x68 cm
9985-4006730 *
9985-1001626 **



9985-1004926

9985-1004928

9985-1004927

9985-1004929

Acupuncture Model of a Horse

Plastic model on a wooden base; one half of the body shows the Chinese acupuncture points and meridians and the other half of the body shows the skeleton and internal organs.

LxWxH = 26x7x23 cm

9985-1004926

Acupuncture Model of a Cat

Plastic model on a wooden base; one half of the body shows the Chinese acupuncture points and meridians and the other half of the body shows the skeleton and internal organs.

LxWxH = 28x8x19 cm

9985-1004928

Acupuncture Model of a Dog

Plastic model on a wooden base; one half of the body shows the Chinese acupuncture points and meridians and the other half of the body shows the skeleton and internal organs.

LxWxH = 30x9x28 cm

9985-1004927

Acupuncture Model of a Cow

Plastic model on a wooden base; one half of the body shows the Chinese acupuncture points and meridians and the other half of the body shows the skeleton and internal organs.

LxWxH = 26x8x14 cm

9985-1004929

Acupuncture Ears from 3B Scientific – Impressively Real

Experts around the world agree: these true to nature copies of the human ear are of outstanding quality.

The life size acupuncture ear from 3B Scientific is manufactured from high quality 3B SKINlike™ silicon – a guarantee for long life, remarkably realistic surface structures and phenomenal insertion characteristics.

Making it perfectly suited for learning and mastering ear acupuncture.



9985-1000375

9985-1000374



9985-1000373

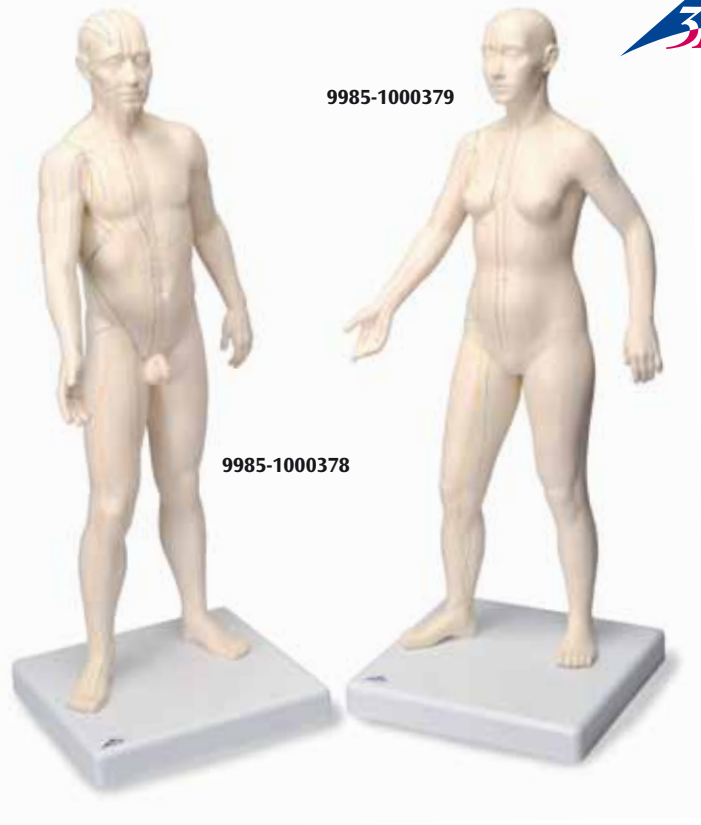

9985-1000379

9985-1000378

3B Acupuncture Model, Female
As 9985-1000378

9985-1000379

3B Acupuncture Ear Set (Left and Right) with Acupuncture Needles

9985-1000373

3B Acupuncture Ear, Left

9985-1000374

Set of 3B Acupuncture Ears, 10 Pieces each, left and right

9985-1000376

3B Acupuncture Ear, Right

9985-1000375

3B Acupuncture Model, Male

This new acupuncture model sets the standard in didactics and aesthetics and has been developed in cooperation with experienced European acupuncture specialists. It is about 70 cm tall and contains 396 acupuncture points. All conduction paths are coloured according to the 5 phases. We have intentionally dispensed with Chinese labelling on the model. This makes the accurate identification of acupuncture points significantly easier. True to the motto: less is sometimes more.

E/D/S/E/I/P/J/R/C www.3b-sc.com

9985-1000378

Please Enquire About SEIRIN® Acupuncture Needles and our High Quality 3B Lasers!

Further information is available at www.3b-acupuncture.co.uk

- 40 mW, red light
- 50 mW, infrared
- 150 mW, infrared
- 500 mW, infrared



9985-4006731 *
9985-1001628 **

You will find our large selection of Charts starting on page 108.

NEW



3B LASER NEEDLE The New Dimension

The new 3B LASER NEEDLE is one of the most attractive innovations in the field of low-level laser therapy. It impressively demonstrates that modern technology and attentive care for the patient are not mutually exclusive.

More information: www.3b-akupunktur.de

All the advantages at a glance:

LASER NEEDLE unit with 12 laser diodes

- Mobile Touch Screen (Control Touch Pad)
- Self explanatory and logical operation
- Low space requirements and high level of mobility
- Perfect Ergonomics
- Reliable and sophisticated technology
- Painless and side effect free treatment
- Broad therapy spectrum
- High patient acceptance
- Low capital expenditure
- Amortisation after only a few treatments
- Comprehensive, fast service
- Made in Germany: guaranteed highest product quality and safety

9985-1004916

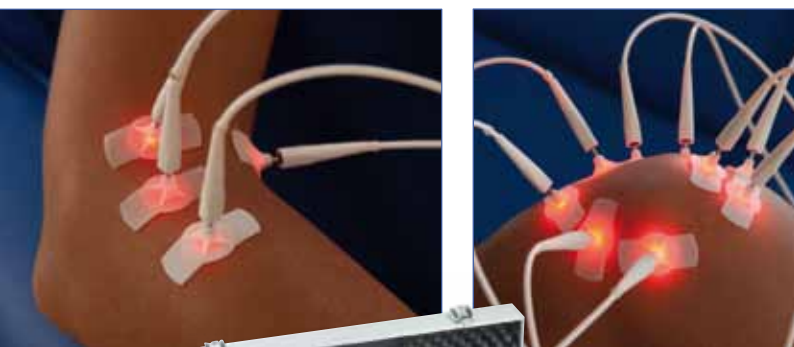

» Traditional Chinese medicine is being continuously advanced by such outstanding innovations and contributes increasingly to public health.

*Dr. Michael Weber, Germany,
President of the European TCM Laser Academy*



Acupuncture



Accurate, Aesthetic, Graphic: the MEDart™ Series by 3B Scientific.

Depicting various areas of the human body, this is a collection of small, artistically sculpted and hand-painted models. Whether you use it as a decorative object at home or in the office, as a detailed patient information aid or as a practical visual model for your training sessions – enjoy the versatility of MEDart™!

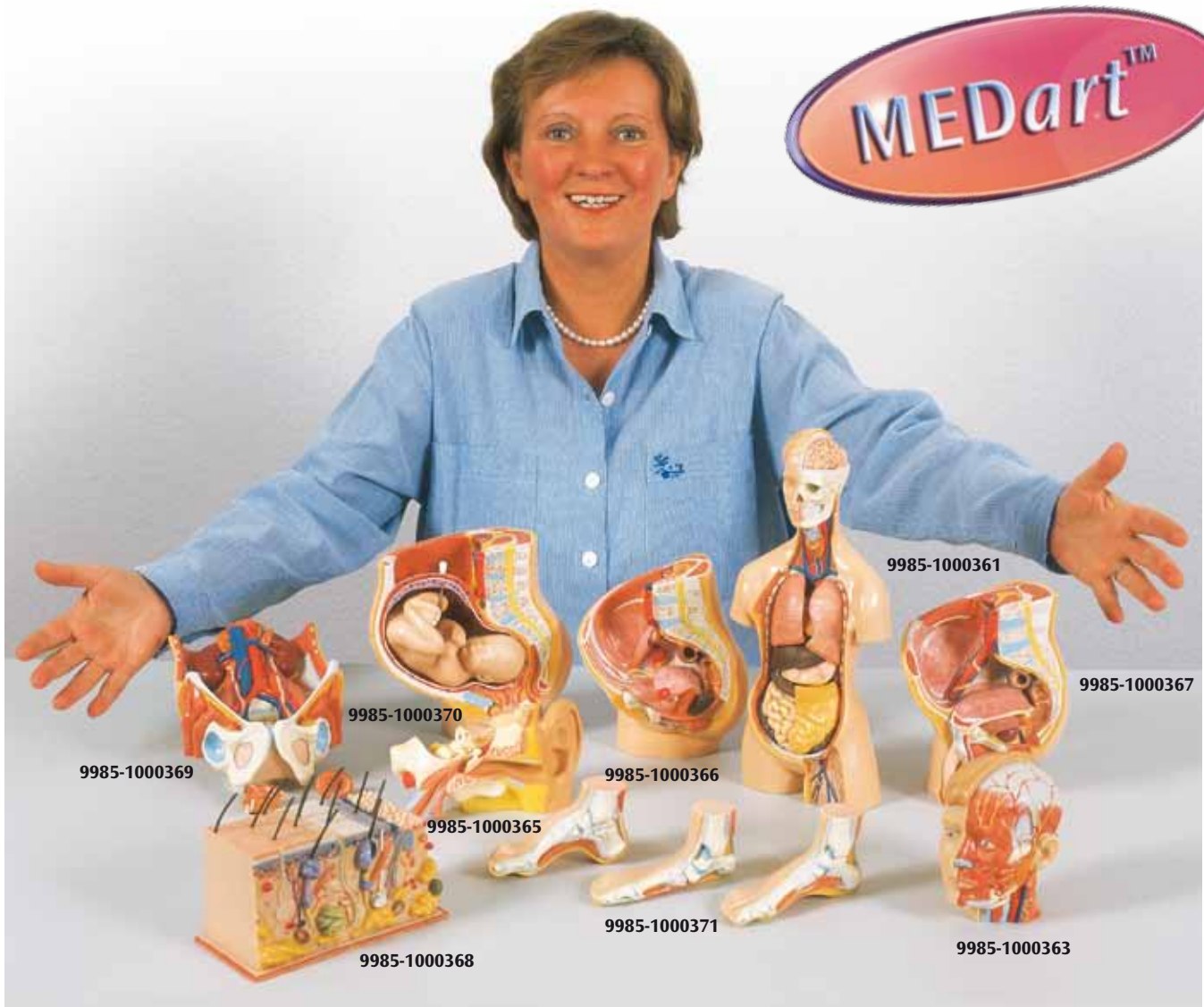

MEDart™

Art. No.	Model	Measures
9985-1000363	MEDart™ Head with Neck	11.5x8.5x10.5 cm; 0.45 kg
9985-1000361	MEDart™ Torso	30x14x6 cm; 1.12 kg
9985-1000366	MEDart™ Female Pelvis	17.5x14x8.5 cm; 0.66 kg
9985-1000367	MEDart™ Male Pelvis	17x14x7 cm; 0.71 kg
9985-1000370	MEDart™ Pregnancy Pelvis	18.5x18.5x9 cm; 1.3 kg
9985-1000369	MEDart™ Urinary Tract	18.5x14x7 cm; 0.65 kg
9985-1000365	MEDart™ Ear	15x5.5x8.5 cm; 0.3 kg
9985-1000371	MEDart™ Foot Series – Normal, Flat and Hollow Feet	each 6x12x4.5 cm; each 0.1 kg
9985-1000368	MEDart™ Block Model of the Skin	10x16x8.5 cm; 0.63 kg

L/E/D/S/F/P/I/J

...going one step further

Medical Art at Affordable Prices

Inspired by various popular 3B models, a circle of talented artists is committed to creating valuable anatomical art objects in small volumes.

Here is a collection of frequently chosen subjects for you – wonderful works of art for your office!

Art. No.	Showcase	Measures
9985-1005327	“Auditory Canal”	24x20x20 cm
9985-1005328	“Tooth with Nerve”	24x20x20 cm
9985-1005331	“Heart Construction Site”, open	24x20x20 cm
9985-1005332	“Cervical Spine”	24x20x20 cm
9985-1005333	“Shoulder Construction Site”	24x20x20 cm
9985-1005334	“Knee Construction Site”	24x20x20 cm
9985-1005340	“Pelvis”	42x40x24 cm



9985-1005340



9985-1005328



9985-1005331



9985-1005327



9985-1005334



9985-1005332



9985-1005333

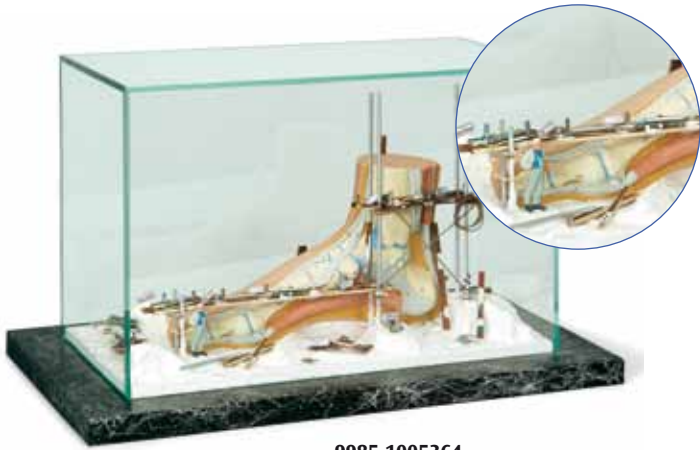

9985-1005364

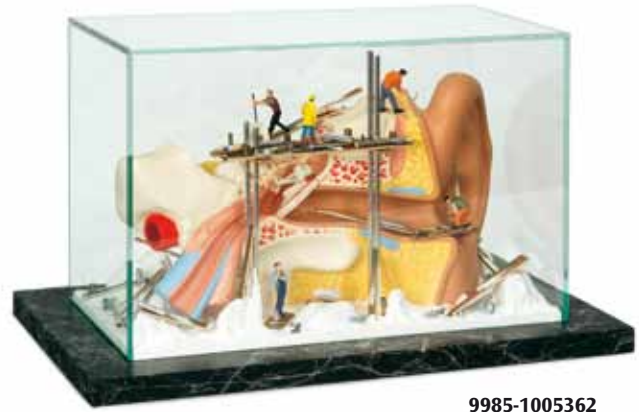

9985-1005362



9985-1005370

NEW



9985-1006534



9985-1005375



9985-1006535

NEW

Art. No.	Showcase	Measures
9985-1005364	"Foot"	24x42x24 cm
9985-1005375	"Muscle Man"	20x20x24 cm
9985-1005370	"Brain"	32x38x33 cm
9985-1005362	"Auditory Canal"	24x42x24 cm
9985-1006534	"Hip" display case with business card holder	15x15x20
9985-1006535	"Knee" display case with business card holder	15x15x20



9985-1006536



9985-1005353



9985-1006537



9985-1005342



9985-1005351

Art. No.	Showcase	Measures
9985-1006536	"Vertebrae/Slipped Disc" display case with business card holder	15x15x20
9985-1006537	"Spine" display case with business card holder	15x15x20
9985-1005342	"Spine"	30x30x42 cm
9985-1005351	"Tooth"	30x30x42 cm
9985-1005353	"Jaw"	25x50x28 cm

**MEDart™ Copper-Like Models –
High Quality and Unique**

A highlight that will brighten any room! Anatomical precision combined with the elegant shimmer of a copper patina. These valuable objects will give unique aesthetic enjoyment to all lovers of exceptional things.

MEDart™ Torso Copper

This high quality miniature is true to anatomical detail and has been hand-refined in a copper tone with an elaborate wiping technique. Can be disassembled into torso body, head, 2 lungs, heart, stomach, liver with gall bladder and intestinal unit. It is not only an object of art but also ideally suited to explain and understand the human anatomy.
33 cm; 1,0 kg

9985-1000362

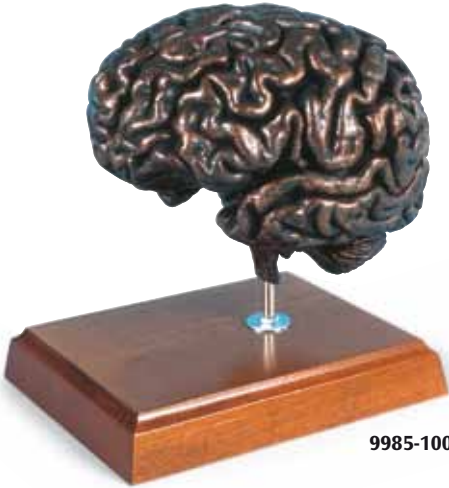

9985-1000364

MEDart™ Brain Copper

Cast from an original, this natural size brain has been refined in a copper tone using an elaborate wiping technique.
16 cm; 0,6 kg

9985-1000364



9985-1000362



MEDart™ Treasures Made of Glass

Modern data and laser technologies make this filigreed masterwork possible! Selected 3B models are presented in 3D inside a cube made of high-quality optical glass. An unusually elegant gift, we supply these precision laser-decorated treasures in a presentation gift box.

8x5x5 cm; 0.5 kg each

MEDart™ Glass Block Skeleton

9985-1002392

MEDart™ Glass Block Skull

9985-1002393

MEDart™ Glass Block Heart

9985-1002396

MEDart™ Glass Block Brain

9985-1002395





9985-1005330



9985-1005335



9985-1005329



9985-1005339



9985-1005338



9985-1005337



9985-1005336



9985-1005341



Art. No.	Image	Measures
9985-1005329	"Heart Construction Site"	24x34 cm
9985-1005330	"Spine"	29x44 cm
9985-1005335	"Knee Construction Site"	29x44 cm
9985-1005336	"Elbow"	28x22 cm
9985-1005337	"Shoulder"	28x22 cm
9985-1005338	"Hip"	28x22 cm
9985-1005339	"Knee"	28x22 cm
9985-1005341	"Acupuncture"	44x29 cm



9985-1005369

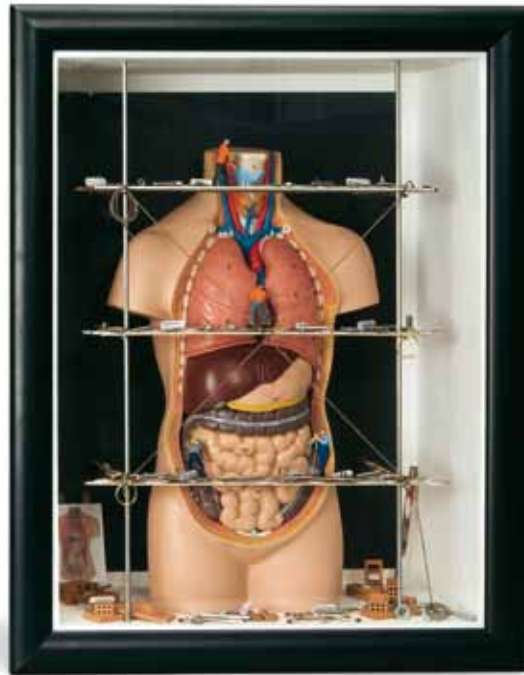

9985-1005366



9985-1005356



9985-1005346



Art. No.	Image	Measures
9985-1005346	"Mouth"	72x52 cm
9985-1005356	"Eye"	72x52 cm
9985-1005366	"Torso"	43x53 cm
9985-1005369	"Spine" XL	52x97 cm

Prints from Donna Krin Korkes

These unusual art prints show anatomical variations and interpretations. Originally painted in oil on canvas, these pictures are reproduced and printed on high quality museum grade paper. These pieces of art, known worldwide for their joyous use of colour, originality of design and high quality of reproduction, will brighten any décor. Supplied unframed.



MEDart™ Neat Feet
61x50.5 cm

9985-1005873



MEDart™ Double Exposure
50x70 cm

9985-1005867



MEDart™ Standing Straight
50x70 cm

9985-1005868



MEDart™ Balancing Act
50x70 cm

9985-1005869

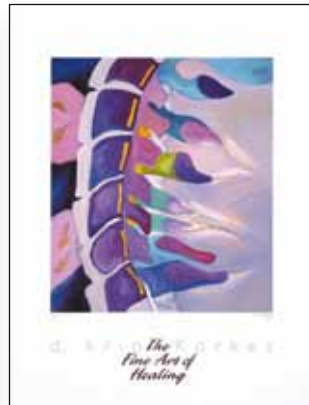

MEDart™ Fugue
45.5x60 cm

9985-1005870

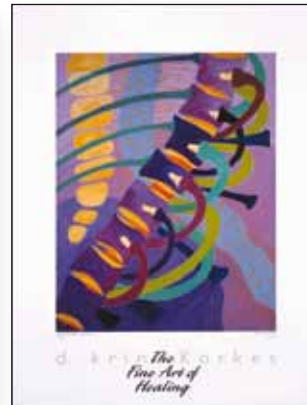

MEDart™ Instrumental Parts
45.5x60.5 cm

9985-1005871



MEDart™ High Five
48x61 cm

9985-1005874



MEDart™ Redux
66x84 cm

9985-1005872



Pop-Art Poster "Running Stan"

Artfully transposed into bright colours and printed on high quality film, our skeleton "Stan" has been turned into an original eye-catcher. The film increases the artistic brilliance and is UV and smudgeproof. Supplied unframed.

**MEDart™ Poster Skeleton,
4 motifs, Background Black**
50x70 cm

9985-1002401

T-Shirt 100% Cotton



Musculature
 XL = 9985-1005505
 L = 9985-1005506



Skeleton
 XL = 9985-1005503
 L = 9985-1005504



Brain
 XL = 9985-1005517
 L = 9985-1005518

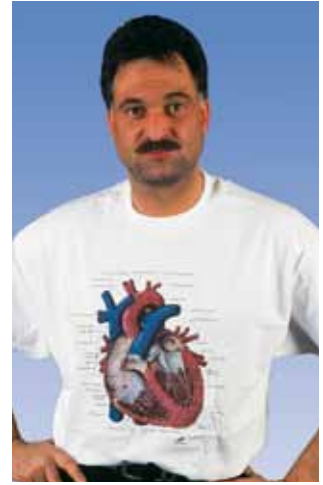

Heart
 XL = 9985-1005509
 L = 9985-1005510



Spine
 XL = 9985-1005514
 L = 9985-1005515



"I'm going one step further"
 XL = 9985-1005527



9985-1005526
 9985-1005525 9985-1005522 9985-1005524 9985-1005519 - 9985-1005521
 9985-1005523

Silk Neckties

"Going One Step Further"
 9985-1005525 Pink
 9985-1005526 Black

Sport Skeleton Neckties:
 9985-1005519 Black
 9985-1005520 Red
 9985-1005521 Grey

Spine, Black
 9985-1005522

"Eating Skeleton", Red
 9985-1005523

"No Smoking", Blue
 9985-1005524

Gonorrhea, Blue
 9985-1005499

Gonorrhea, Grey
 9985-1005500



9985-1003805

Bath Towel "Muscleman"
 145x77 cm

9985-1003805



9985-1005466

Magic Thinking Cap

This cap doesn't make you any cleverer but you'll surely stand out in a crowd. 100% cotton, one size fits all.

9985-1005466



9985-1005499

9985-1005500

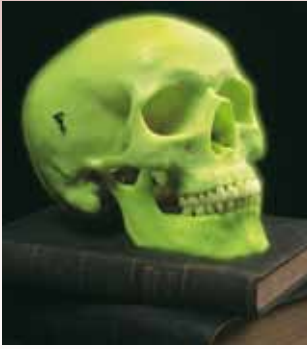

Neon Skull

This skull is an illuminating example of human anatomy. Just as you have come to expect from 3B Scientific®, all anatomical details are not only true but glow in the dark as well! A great gift for Halloween or for those students or friends needing a flash of inspiration. 20x13.5x15.5 cm; 0.6 kg

9985-1000050



9985-1002500

Desktop Mini-Skull

An anatomical as well as ana(c)omical addition to your home or office.

9985-1002500

Mini-Skeleton for Mini-Budget

Surprise your friends, patients or colleagues with this unusual ana(c)omical gift. 48 cm

9985-1005099



9985-1005099



9985-1005467

Jumbo Sized Lumbar Mug

9985-1005467



9985-1000181

Femur Bone Penholder

Without pens. 45 cm

9985-1000181



9985-1003646

Finger Bone Pen

16 cm

9985-1003646



9985-1008546

Bone with Knot

A thigh bone paperweight with a knot to remind practitioners. 0.3 kg

9985-1008546



9985-1000138

Lumbar Penholder

Show everyone that you have really got backbone with this unusual and interesting desk accessory. Without pens.

9985-1000138



Art. No.	Motif
9985-1005458	Skull
9985-1005459	Heart
9985-1005460	Vertebral Column
9985-1005461	Hand
9985-1005462	Feet
9985-1005463	Hip
9985-1005464	Knee
9985-1005465	Molar

12 Eye Key Rings

With movable eyeball, diameter 2.8 cm. The set includes 4 keyrings each in green, blue, red.

9985-1003648



9985-1003648



9985-1003647

Injection Pen

12.7 cm

9985-1003647

Description	Page No.	Description	Page No.
3B ANATOMYtrainer™	95	– C –	
3B BONELike™	29, 30, 33, 34	Cannulation Pad	135
3B MICROanatomy™ Artery and Vein	75	Caries Attack	58
3B MICROanatomy™ Bone Structure	11, 21	Carrying Bag	103, 122, 134, 145, 146, 148, 152, 154
3B MICROanatomy™ Digestive System	10, 76	Casualty Simulation Kit I – IV	164, 165
3B MICROanatomy™ Eye	10, 67	Catheterisation	10, 121, 122, 123
3B MICROanatomy™ Kidney	11, 79	CD-ROM Histopathology, English	96
3B MICROanatomy™ Liver	10, 77	Central Venous Cannulation Simulator	133
3B MICROanatomy™ Muscle Fibre	11, 47	Cerebrospinal Fluid Circulation	63
3B MICROanatomy™ Tongue	10, 60	Cervical Spinal Column	34
3B MUSCLEtrainer™	95	Chart Display Stand	114
3B NEUROtables™	96	Charts	108-119
3B NEUROteacher™	96	Chest Drain Simulator	145
3B NEUROtrainer™	95	Chester Chest™	134
3B Scientific® Pregnancy Series	82	Child ACLS Manikin with Interactive Arrhythmia Simulator	157
3B Scientific® Beauchene Skull, Didactic Coloured Version	28	Child Interactive PALS Manikin	158
3B Scientific® Life-Size Dual Sex Asian Muscular Figure	45	Child Patient Care Manikin	102
3B Scientific® Life-Size Dual Sex European Muscular Figure	45	Child Water Rescue Manikin (3 years old)	163
3B Scientific® Patient Care Manikin, I – II	104	Childbirth Demonstration Pelvis	85
3B Scientific® Pregnancy Series	82, 83	Childbirth Simulator	84, 85, 88
3B Scientific® Skull Kit – Anatomical Version	28	Chronic Obstructive Pulmonary Disease (COPD)	12
3B Torso Classroom Set	49	Circulatory System	75
3B Torso Guide	48	Clinical Breast Trainer	90, 128
– A –		Concentrated Simulated Vomit	141
Abdominal Open and Closure Trainer	85, 144, 145	Condoms / Condom Training	92, 99
Acupuncture Models	166, 167	Contraception	11, 92, 99
Acupuncture Ears	167	Corpuient Manikin “Fat Old Fred Manikin”	151
Adult ACLS Manikin with Interactive Arrhythmia Simulator	159	CPR	5, 146, 147, 151, 152, 153, 154
Adult ACLS Torso with Interactive Arrhythmia Simulator	159	Cricotracheotomy Trainer	120, 160
Adult Airway Management Trainer	142, 162	CT Bronchial Tree with Larynx	71
Adult Choking Torso	148	– D –	
Adult Dentures	60	Decubitus Treatment Simulator	10, 122
Adult Trach Tube	120	Degenerative Lumbar Set, 4-Stage	36
Advanced Child Airway Management Trainer	140, 155	Demonstration Skulls	27
Advanced Half Lower Jaw with 8 diseased teeth	60	Dental Disease	59
Advanced Venipuncture and Injection Arm	136	Dental Morphology Series	59
AIDS-Virus	99	Dentition Development	60
Airway Demonstration Model	141	Desktop Ear Model	70
Airway Management Trainer	140, 161	Desktop Skeleton	20
Airway Systems	146, 152, 163	Diabetes, Injection Simulator	11
Airway/Lung/Face Shield Systems	146, 148	Didactic Flexible Spines	31
Arms and Legs	46, 47, 135, 150	Didactic Skull on Cervical Spine	27
Arterial Puncture Arm	131	Digestive System	15, 76
Arterial Stick Arm	106, 131	Disarticulated Skeletons	21
Arteriosclerosis Model, with Cross Section of Artery	75	Disc-Torso	55
Artificial Blood	85, 132, 133, 134, 135, 136	Diseases of the Oesophagus	78
Artificial Semen	92, 99	Display Case “Hip” with Business Card Holder	171
Atlas and Axis	34	Display Case “Knee” with Business Card Holder	171
Atlas and Axis, with occipital plate	34	Display Case “Spine” with Business Card Holder	172
Auscultation Trainer and SmartScope™	125	Display Case “Vertebrae/slipped disc”	
Auscultation Trainer, (Body only)	125	with Business Card Holder	172
– B –		Dissectable Muscled Arm	46
Baby “Arti”, “Ivy”, “Hippy”, “Stap”	100, 131, 132, 139	DNA Double Helix	94
Baby Care Model	100, 101,	Double-Sided Skin Suture Pad	124, 144
Bandaging Simulator	125	Down’s Syndrome Dolls (Trisomy 21)	98
Basic Heart Sounds	126	Dual Sex Muscle Figure	42
Basic Kidney Section	79	Dual Sex Torsos	51, 52, 53, 54
Basic Murmurs	126	Dual Sex Urinary System	80
Basic Patient Care Manikin	103	Dust Cover for Skeletons, Heavy Duty	17
Birthing Process / Birthing Station Simulator	84	– E –	
Blood Pressure	105, 126, 127	Ear Examination Simulator	130
Brad™ Compact CPR Training Manikin	151	Early Pregnant Uteri	91
Brain	61, 62, 63	Ears	9, 12, 70
Breast Examination Module	107	Earwax	130
Breast Self Examination Model	91, 128	ECG-Simulator	156
Breath Sounds	126	Economy Adult Airway Management Trainer	142, 162
Buttock Injection Simulator	138	Elbow Joint	39
		Elderly Care and BLS Manikin	105

Description	Page No.	Description	Page No.
Elderly-Care Manikin, I – III	103	Gynaecology Simulator	91, 92
Embryo / Embryonic Development	82	– H –	
Emergency Laryngoscope	141, 160	Haemorrhoid Model	78
Endocrine System	15	Half Head with Musculature	57
Endotracheal Intubation Simulator	141, 162	Half Lower Jaw	60
Enema Administration Simulator	121	Halogen Bulbs	130, 141
ENT diagnostic set	130	Hand and Wrist, Deluxe	23
Episiotomy Suturing Simulator	89, 124	Hand Skeleton Models	23
Eyes	65, 66	Head and Neck	57, 58
– F –		Head Models	12, 57
Face Mask	141, 150	Head Musculature	58
Family Planning Educator	92, 99	Head Section Model	149
Feeding Organs and Metabolism in the Human Body	97	Heart and Breath Sounds Simulator	126
Female breast and chest wall	90	Heart Models	73, 74
Female Muscular Figure, Complete	44	Heart on Diaphragm	73
Femoral Fracture and Hip Osteoarthritis	40	Heart with Conducting System	73
Femoral Injection Pad	157	Heart with Bypass	74
First Aid/Trauma Arms and Legs	150	Heart with Left Ventricular Hypertrophy (LVH)	74
Flat Foot (Pes Planus)	24	Heart with Oesophagus and Trachea	74
Flexible Spines	31, 32	Heart with Thymus	72
Fluid Supply Bag	136	Heart, assembled in parts	72, 73, 74
Fluid Supply Stand	136	Heredity and Genetics of Man, Part I – II	97
Fluid-filled Cysts	128	Herniated Disc Simulator	36
Foam Pad	143	Hip Joint	39
Foetal Monitoring and Labour Progress Model Set	84	Histology of Man and Mammals	97
Foetal Skull	28	Hollow Foot (Pes Cavus)	24
Foetus for Vacuum Delivery	88	Hormones, Hormone System and Control	97
Foetus Model	85	Hormone, Inplant	11
Foetus, 4th Month, transverse lie	82	Human Parasites and Diseases	97
Foetus, 5th Month	82	Human Pathology	15
Foetus, 5th Month, breech position	82	Human Respiratory and Circulatory Systems, the Human Heart	97
Foetus, 7th Month	82	Human Skeleton, Musculature and Apparatus of Movement	97
Foetus, Articulating	88	Human Skin Series with Burn Pathologies	56
Foot and Ankle, Deluxe	23	Hydrocephalic Skull	27
Foot Skeleton Models	24	Hyoid bone on stand	21
Forensic Science Wound Simulation Kit	165	Hypertension Model	75
Fred Deluxe Skeleton	19	– I –	
Fred Deluxe Skeleton	19	I.m. Injection Simulator	137, 138
Free-Standing Urinary System	80	I.U.D Trainer	92, 99
Front Teeth	141	I.v. Injection	101, 102, 132, 133, 134, 135, 136
Full Term Newborn for Forceps Delivery	85	I.v. Lower Arm with Hand	154
Functional Ear Model	70	I.v. Torso	133
Fun Products	177, 178	I.v. Training Hand	135
Functional Elbow Joint	41	Infant Arterial Training Arm	130
Functional Elbow Joint Model, Deluxe	41	Infant Choking Manikin	147
Functional Eyes	67	Infant Heart and Breath Sounds	126
Functional Heart and Circulatory System	75	Infant IO Leg	130
Functional Hip Joints	41	Infant Patient Care Manikin	101
Functional Knee Joints	41	Infant Venous Access Simulator	132
Functional Larynx	71	Infusion Bottle	134
Functional Shoulder Joints	41	Inguinal Hernia Model	81
Functional Skeleton Model “Frank”	19	Injection Arm	100, 102, 136
Functional Skull with Masticator Muscles	26	Instrument Kit (puncture needle and syringe)	139
Fundus Skills and Assessment Module	107	Interactive Birthing Simulator	89
– G –		Interactive ECG-Simulator	159
Gallstone Model	78	Internal Finger Structure Model	23
Gastric Band	7	Internal Hand Structure Model	23
General Parasitology	15	Intervertebral Discs on Nylon	21
Genital System	15	Intestinal Diseases	7, 11
Geriatric IV Arm	135	Intestinal Villi, 100 times life size	10, 77
Giant Brain	63	Intra-muscular Injection Pad	137
Giant Dental Care Model	59	Intradermal Injection Simulator	137
Giant DNA Model	94	Intramuscular Injection Simulator	6, 137
Giant Ear	69	Intraosseous Leg, Bones, Skin	155, 157
Giant Heart	73	Introductory Brain	61
Giant Molar with Dental Caries	59	Intubation Head	140, 155, 161
Giant Toothbrush	59		
Glass Cell	94		

Description	Page No.	Description	Page No.
Intubation Torso	142, 162	Mini Vertebral Columns	31
Intubation Trainer™	140, 160	Mitosis Model	93
– K –		Model of Kidney Vessels	80
Kidney Sections	79	Motor End Plate	64
Kidney Stone Model	81	Motor Neuron Diorama	46, 64
Kidney with Adrenal Gland	79	Mouth/Nose Pieces	146, 152, 154, 163
Kidneys with Rear Organs of the Upper Abdomen	76	Multifunctional Spinal Column Stand	32
Kidneys with Vessels	79	Muscle Figure, Female	42
Knee Joint / Deluxe Knee	39, 40	Muscular Arm	46
– L –		Muscular Figure	44
Labour Delivery Module	88	Muscular Figure, Complete, Dual Sex, with Internal Organs	44
Labour Stages Model	84	Muscular Leg	47
Laparoscopic Trainer	144	Muscular Leg	47
Laryngoscope, Deluxe	141, 160	Muscular System on Study Cards	119
Larynx	71	Myelin Sheaths of the CNS	64
Laser Needle	168	– N –	
Laser Pointer	114	Nasogastric Intubation Model	121
Life size Auditory Ossicles	70	Neoprene Sheets	144
Life size Male Muscular Figure	43	Nephrons and Blood Vessels	79
Life size Muscle Torso	43	Nervous System	15, 65
Life/form® NG Tube and Trach Skills Simulator	120	Nervous System and Transmission of Information, Part I – II	97
Lifetime Flexible Spine	31	Neuro-Anatomical Brain	62
Lifetime Flexible Spine with Femur Heads	31	Neuron Cell Body	64
Lifting Demonstration Figure	34	Neurovascular Skull	28
Lig. Flavum, Vertebral Bones and Intraspinous Ligament	139	Newborn Patient Care Baby	101
Ligamented Female Pelvis	37	Newborn Water Rescue Manikin	163
Little Anne Airways	149	Normal Foot	24
Little Anne®	149	Nose and Olfactory Organ	12, 68
Little Junior	148	Nose with Paranasal Sinuses	68
Little Junior, Dark Skin	148	Numbered Classic Skull	26
Liver with Gall Bladder	77	Nurse Training Baby	100
Lower Canine	58	Nursing Anne	107
Lower Incisor	58	Nursing Baby	102
Lower Muscled Leg with Knee	47	Nursing Kelly	106
Lower Single-Root Pre-Molar	58	Nursing Kid	102
Lower Stump Bandaging Simulator	125	– O –	
Lower Twin-Root Molar Showing	58	Organ Board	144
Lubricants	87, 120, 121, 129, 139, 141	Organ of Corti	12
Lumbar Epidural Injection Trainer	139	Osteoporosis Models	35, 36
Lumbar Spinal Column	34, 35	Ostomy Care	123
Lumbar Vertebrae	34, 35	– P –	
Lumpy Axillary Gland / Lumps	128, 129	Paediatric Breath and Heart	126
Lung Models	72	Paediatric Head	132
Lung/Mouth Protection Bags	152	Paediatric Heart	126
Lungs	140, 157, 159	Palpation Module for Leopold's Manoeuvres	88
– M –		PALS Baby with ECG-Simulator	155
Malpighian Corpuscle of Kidney	79	PALS Manikins	156
Manikin Face Shields	150	Pathogenic Bacteria	15
Mastectomy Module	107	Patient Care Manikin	105
MEDart™	169-176	Pelvic Model	85
Median and Frontal Section of the Head	57	Pelvic Skeletons	32, 37, 81
Median Section of the Head	57, 58	Pelvis	37, 81
MegaCode Kelly Advanced (VitalSim™-Capable)	158	Pelvis and Pelvic Floor, Female	37
MegaCode Kelly VitalSim™ Basic (ECG Only)	158	Pelvis Section, Male	80
Meiosis Model	93	Pelvis with Ligaments	37, 38
Methyl cellulose to prepare tracheal secretions	120	Pericardiocentesis Kit	145
Microcephalic Skull	27	Physical Eye Model	66
Microscopes	12, 13, 14	Physical Therapy Skeleton	19
Milk Dentures	60	Physio Baby	98, 101
Mini Cricotracheotomy	120, 160	Physiological Skeleton Phil	19
Mini Elbow Joints	41	Physiology of Nerves Series	64
Mini Hip Joints	41	Pink Skin with Fatty Tissue	144
Mini Knee Joints	41	Placenta and Umbilical Cord	83, 85
Mini Shoulder Joints	41	Pleural Cavity	162
Mini Skeleton "Shorty"	20	Pneumothorax Kit	145
Mini Skull	28	Pneumothorax Training Manikin	162
Mini Torsos	55		

Description	Page No.	Description	Page No.
Pocket Mask	151	STAT Baby	155
Pocket Otoscope	130	Sternum with Rib Cartilage	21
Postpartum Uterus	91	Stethoscope	126
Pregnancy Pelvis	83	Stethoscope Sounders	126
Pregnant Belly Overlay	85	Stoma Care Training Model I – II	10, 123
Pressurised Cannulation Pad	135	Stomach	7, 76, 140, 157, 159
Prostate Examination	129	Stomach with Ulcers	78
Prostate Model	80	Storage Case for ACLS Torso	159
Protective device cover	87	Study and Information System for Selfstudy	119
Pulmonary lobes	72	Stump Bandaging Simulators	125
– R –			
Rat Brain Comparative Anatomy	63	Stylus pen for touchscreen	87
Rear Organs of the Upper Abdomen	76	Supplementary Ears	130
Regional Brain	63	Support Sheet for Pink Skin	144
Reproduction and Sex Instruction	97	Surgery and Laparoscopy Torso	144
Rescue Manikins	163	Surgery Trainer	124, 143
Respiratory and Circulatory System	15	Suture Practice	124, 143
Resusci Anne CPR	150	Synapse	64
Resusci Junior	148, 149	Synthetic Skin	141
Rib Cage / Ribs	21, 145	– T –	
Rods for Charts 50 and 98 cm	108	Testicle Self Examination Model	129
– S –			
Sacrum and Coccyx	34	Thin Man – Sequential Human Anatomy Programme	119
Sam Deluxe Skeleton	18	Thoracic Spinal Column	34
Sanitary Face Masks	153	Tissues	15
Schwann Cells of the PNS	64	Tongue Model	60
Scelerotherapy, Ultrasound	6	Tooth Model Series, Classic, 5 models	58
Sectional Knee Joint	40	Torso, African	50, 53
Segmented Lung Reproduction	72	Torso, Asian	53, 54
Sense Organs as a Window to the World	97	Torso, Deluxe, Male, with Head	51
Sensory Organs	15	Torso, Female Deluxe	51
Seymour II™ Decubitus Treatment Simulator	122	Tracheal Airways	153
Shoulder Joint with Rotator Cuff	39	Tracheotomy Care Simulator	121
Sigmoidoscopic Examination Simulator	129	Training Model for a Female Condom	92, 99
SIMone™ Birth Simulator	87	Transparent Skin for Daylight Use	144
Simulated Amniotic Fluid	85	Trauma Moulage Kit	154
Simulated Stool	123	Tubing Systems	134
Sinusitis	12	Twin Foetuses, 5th Month, normal position	82
Skeletal System on Study Cards	119	Two-in-One i.m. Injection Model of Buttock	138
Skeleton Leo	17	– U –	
Skeleton Max	17	Umbilical Cord / Umbilical Cord Clamps	85
Skeleton Stan	16	Unisex Torsos	48, 49, 50
Skin	162	Upper Incisor	59
Skin and Veins	102, 105, 132, 136, 157, 159	Upper Stump Bandaging Simulator	125
Skin Cancer Model, 6 Different Stages	56	Upper Triple-Root Molar	58, 59
Skin Flap	133	Urethral and Supra-pubic Catheterisation Trainer	122
Skin Model	56	Urethral Catheter, CH16	121
Skin Section	56	Urinary System, Male	80
Skin Section	11, 56	Uteri – Normal and with External Pathologies	91
Skin Suture Trainer	124, 144	– V –	
Skin with 3 Artery Sections	131	Vascular Arm	75
Skin, Block Model	11, 56	Veins, Vein Replacement Kit	6, 136
Skin, Musculature and Spinal Cord	139	Venous Access Device Model, Deluxe	133
Skull on Cervical Spine	25	Vertebrae	34
Skull with Brain, Classic	26	Virkon tablets	150
Skull with Cleft Jaw and Plate	27	VitalSim™	102, 106, 158
Skull with Opened Lower Jaw, Classic	26	Vulva	85
Skull with Opened Lower Jaw, Classic, painted	26	– W –	
Skull with Teeth for Extraction	26	Wearable Breast Self Examination Model	90, 128
Skull, Classic	25, 26	World's Largest Ear	69
Skull, Classic, transparent	25	Wound Care and Assessment Set	106, 107
Spinal Cord Fluid-Filled Sachets	139		
Spinal Cord with Nerve Endings	64		
Spinal Injection Simulator	139		
Spongiosa	8		
Sports Shoulder	40		
Stages of Disc Prolapse and Vertebral Degeneration	35		
Stages of Fertilisation and Development of the Embryo	83		



3B Scientific History



The international 3B Scientific group of companies is the world's largest and most experienced manufacturer of anatomical teaching aids. The oldest production site was set up as early as 1819 in Budapest, Hungary. The continuously growing success of 3B Scientific is the result of global expansion, based on the production and sales of high-quality medical and scientific teaching aids available at fair prices. The internationally registered brand name 3B Scientific® can be found around the world in the fields of natural sciences, medical training and patient education. The product range includes products for lectures in physics and biology as well as anatomical models, software and charts, medical simulators, acupuncture and other therapy products. The company has been awarded the DIN EN ISO 9001:2008 certification for the excellent quality of its services, products and organizational structures. This official step towards quality management emphasizes the continuing process of innovation, product improvement and customer orientation that is associated with the brand name 3B Scientific®.

3B stands for: *Best Quality Best Value Best Service*



- 1819 Calderoni founded in Budapest, Hungary
- 1912 Training Workshops of the German Hygiene Museum founded in Dresden
- 1948 Paul Binhold Lehrmittelfabrik founded in Hamburg
- 1950 Production of the first plastic skeleton
- 1952 First skeleton manufacturing plant opened
- 1963 New headquarters at Rudorffweg, Hamburg
- 1965 Introduction of the Torso product line
- 1970 Introduction of the Binhold company logo
- 1979 Anatomical models first exported to the USA
- 1983 First manufacturing of injection moulded skeleton parts
- 1986 Care simulators added to the product range
- 1988 Anatomical models first exported to Japan
- 1991 DHM Lehrmittelfabrik GmbH founded in Dresden
- 1993 Acquisition of Calderoni and foundation of Biocalderoni in Hungary
- 1995 American 3B Scientific founded in Atlanta, USA
- 1996 New logo for the 3B Scientific Group
- 1997 Nihon 3B Scientific founded in Niigata, Japan
- 1998 France 3B Scientific founded in Bartenheim, France
- 1998 Merger of Paul Binhold Lehrmittelfabrik GmbH and DHM Lehrmittelfabrik to form 3B Scientific GmbH
- 1999 China 3B Scientific founded in Suzhou, China
- 2000 DIN EN ISO 9001 certification
- 2001 Introduction of the full 3B Scientific® product range for physics
- 2002 Italy 3B Scientific founded in Bologna, Italy
- 2003 España 3B Scientific founded in Valencia, Spain
- 2003 UK 3B Scientific founded in Weston-super-Mare, United Kingdom
- 2004 All-European distributor of SEIRIN® acupuncture needles
- 2004 Acquisition of ELWE Didactic GmbH in Klingenthal
- 2005 Acquisition of TELTRON® brand name and production
- 2005 Russia 3B Scientific founded in St. Petersburg.
- 2006 Brasil 3B Scientific founded in Joinville, Brasil.
- 2007 Thai 3B Scientific Co Ltd., founded in Bangkok, Thailand
- 2009 DIN EN ISO 9001:2008 certification

...going one step further



Page 28



Page 9



Page 55



Page 59



Page 137



Page 40



Page 86



Page 4



Page 12



Page 134