

Gas Triode S with He-Filling 1000618

Instruction sheet

10/15 ALF

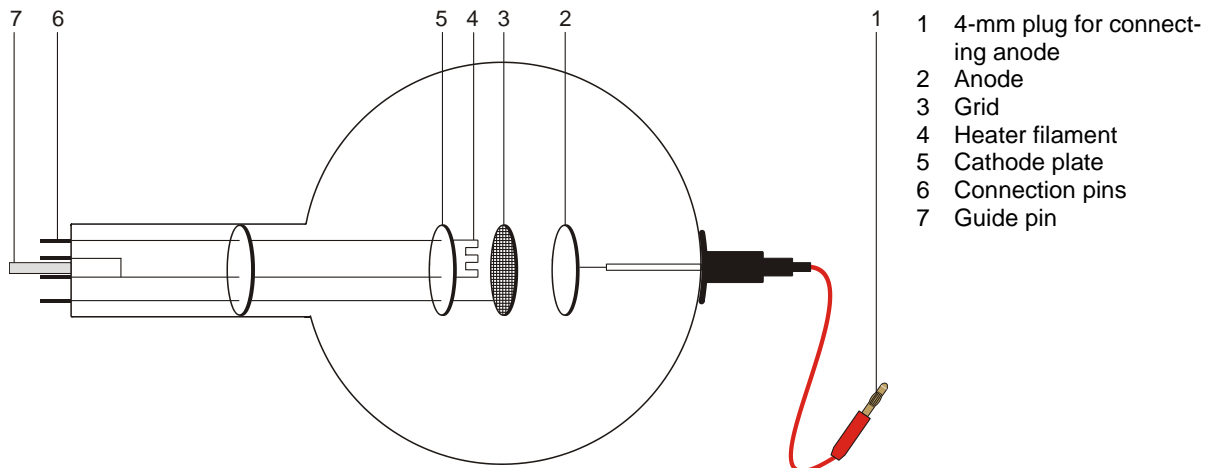

1. Safety instructions

Hot cathode tubes are thin-walled, highly evacuated glass tubes. Treat them carefully as there is a risk of implosion.

- Do not subject the tube to mechanical stresses.
- Do not subject the connection leads to any tension.
- The tube may only be used with tube holder S (1014525).

When the tube is in operation, the terminals of the tube may be at high voltages with which it is dangerous to come into contact.

- Only use safety experiment leads for connecting circuits.
- Only change circuits with power supply equipment switched off.
- Only exchange tubes with power supply equipment switched off.

If voltage or current is too high or the cathode is at the wrong temperature, it can lead to the tube becoming destroyed.

- Do not exceed the stated operating parameters.

When the tube is in operation, the stock of the tube may get hot.

- Allow the tube to cool before dismantling.

Use of the equipment over long periods and involving hefty gas discharges can cause loss of material from the electrodes, which is deposited on the glass of the tube itself resulting in darkening of the surface.

The compliance with the EC directive on electromagnetic compatibility is only guaranteed when using the recommended power supplies.

2. Description

The gas triode allows recording of the $I_A - U_A$ characteristic of a thyatron, observation of excited and non-excited discharge and of the discontinuous transfer of energy by helium atoms in inelastic collision with free electrons.

The gas triode is a helium-filled tube with a pure tungsten heater filament (cathode) and a round metal plate (anode) with a wire grid between them, all inside a clear glass bulb. The cathode, anode and grid are all aligned parallel to one another. This planar configuration corresponds to the conventional symbol for a triode. A circular metal plate attached as a backing to the filament ensures that the electric field between the anode and cathode is uniform.

3. Technical data

Gas filling:	Helium
Filament voltage:	≤ 7.5 V AC/DC
Anode voltage:	max. 400 V DC max.
Anode current:	10 mA typ. at $U_a = 300$ V
Grid voltage:	max. 30 V
Glass bulb:	130 mm diam. approx
Length of tube:	260 mm approx.

4. Operation

To perform experiments using the gas triode the following equipment is also required:

1 Tube holder S	1014525
1 DC Power supply 500 V (@115 V)	1003307
or	
1 DC Power supply 500 V (@230 V)	1003308
2 Analogue multimeter AM50	1003073

4.1 Setting up the tube in the tube holder

- The tube should not be mounted or removed unless all power supplies are disconnected.
- Press tube gently into the stock of the holder and push until the pins are fully inserted. Take note of the unique position of the guide pin.

4.2 Removing the tube from the tube holder

- To remove the tube, apply pressure with the middle finger on the guide pin and the thumb on the tail-stock until the pins loosen, then pull out the tube.

5. Example experiments

5.1 Discharge, evidence of positive charge carriers

- Set up the circuit as in fig. 1.
- To demonstrate the existence of positive charge carriers (He^+ ions) for gas discharge at a maximum heater filament voltage U_F , measure the current I_G taking note of the sign.

5.2 Non-self-sustaining discharge

- Set up the circuit as in fig. 2.
- Record a characteristic curve of I_A against $U_A (= U_G)$ for various filament voltages U_F (5 V ... 7.5 V).

At about 25 V the anode current I_A increases considerably in the gas triode. This increase is

accompanied by the appearance of a blue luminescence. It is apparent that there are many more charge carriers transporting charge than in the vacuum triode (since there are He^+ ions as well as thermal electrons).

5.3 Self-sustaining discharge

- Set up the circuit as in fig. 3.
- Gradually increase the anode voltage U_A and determine the striking voltage U_S for the gas discharge.
- Reduce the anode voltage U_A again until the self-sustaining discharge ceases. Record this extinguishing voltage U_E .

5.4 Simplified Franck-Hertz-set-up

Experiment for demonstrating discontinuous energy emission resulting from inelastic collisions between electrons and helium atoms. The electrons have to travel through a decelerating reverse-potential field between the grid and anode, so that they only arrive at the anode if they possess sufficient kinetic energy. Only then do they contribute to the current I_A between anode and ground.

- Set up the circuit as in fig. 4.
- For a reverse polarity U_R of 6 V, gradually raise the accelerating potential U_A from 0 V to 70 V and measure the anode current I_A .
- Plot a graph of the anode current as a function of the accelerating voltage.

Up to an accelerating potential of about 24 V, the anode current increases but then it drops suddenly. As the accelerating potential is further increased the current increases once again but after another 20 V or so it drops again.

A plot of the anode current should exhibit two clear maxima. If this is not perceptible, the filament voltage should be lowered somewhat.

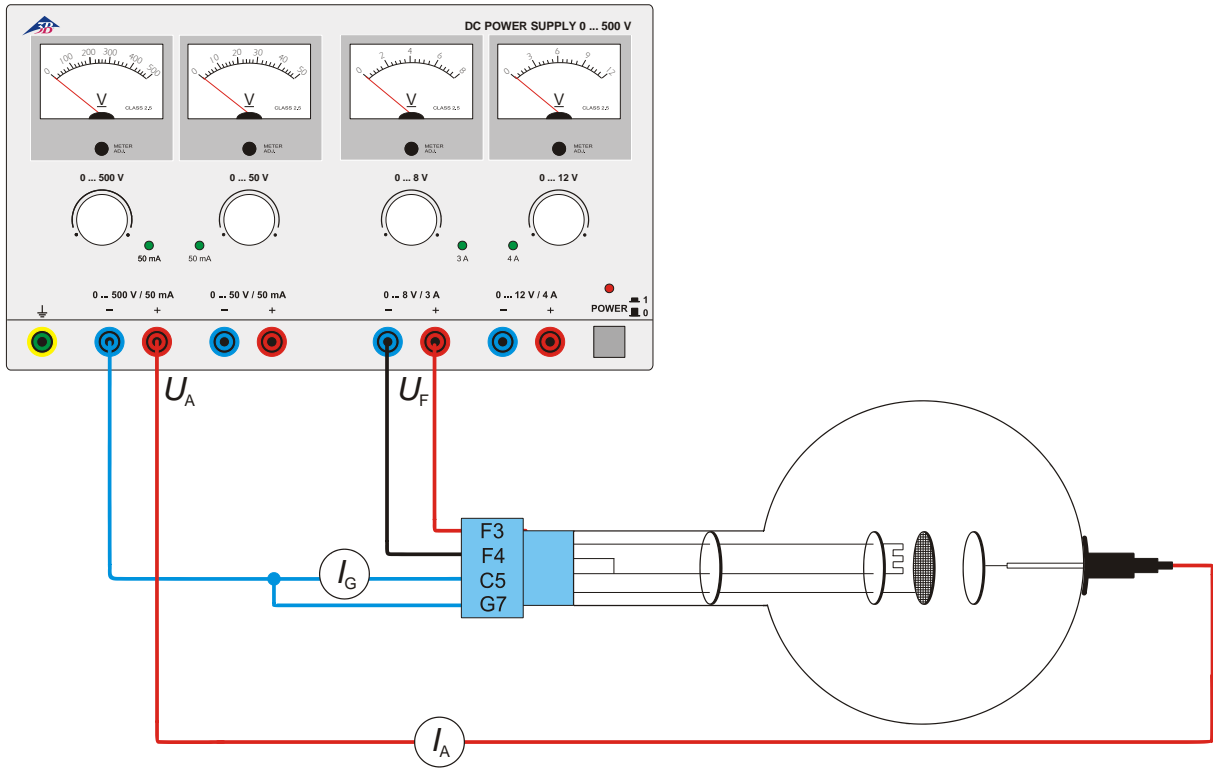

Fig. 1 Evidence for positive charge carriers

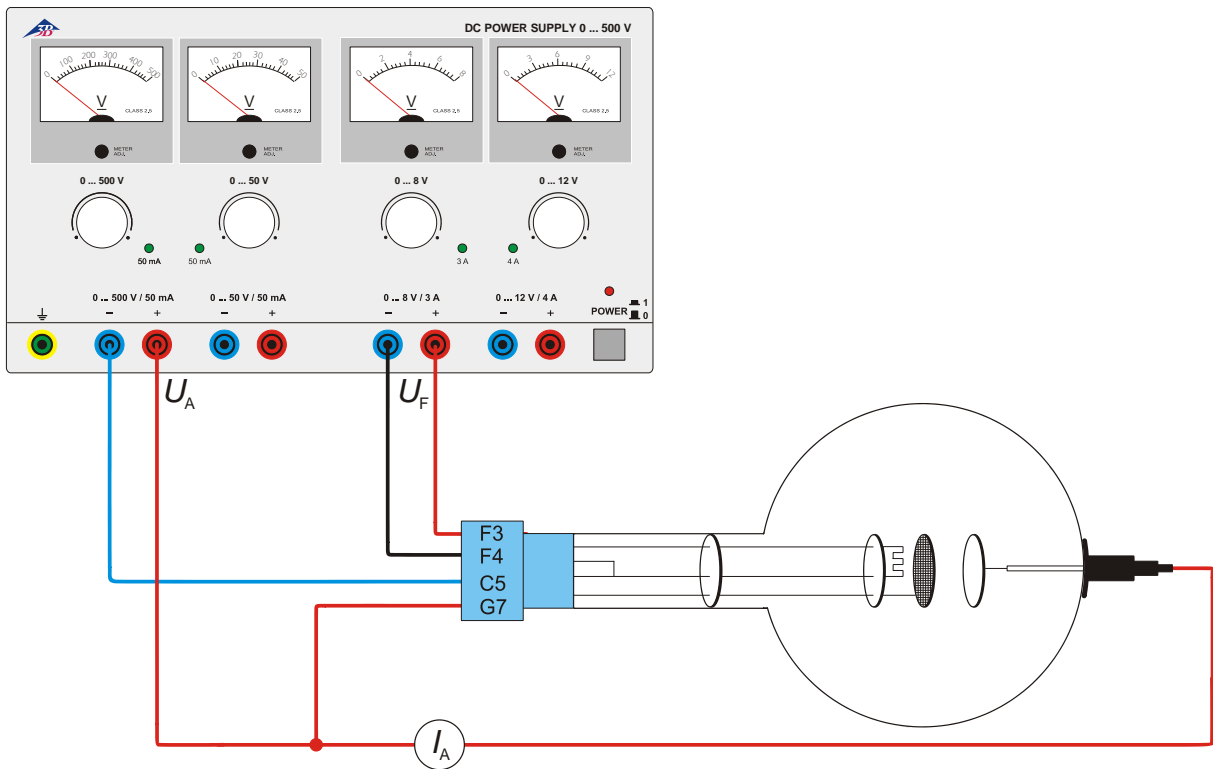

Fig. 2 Non-self-sustaining discharge

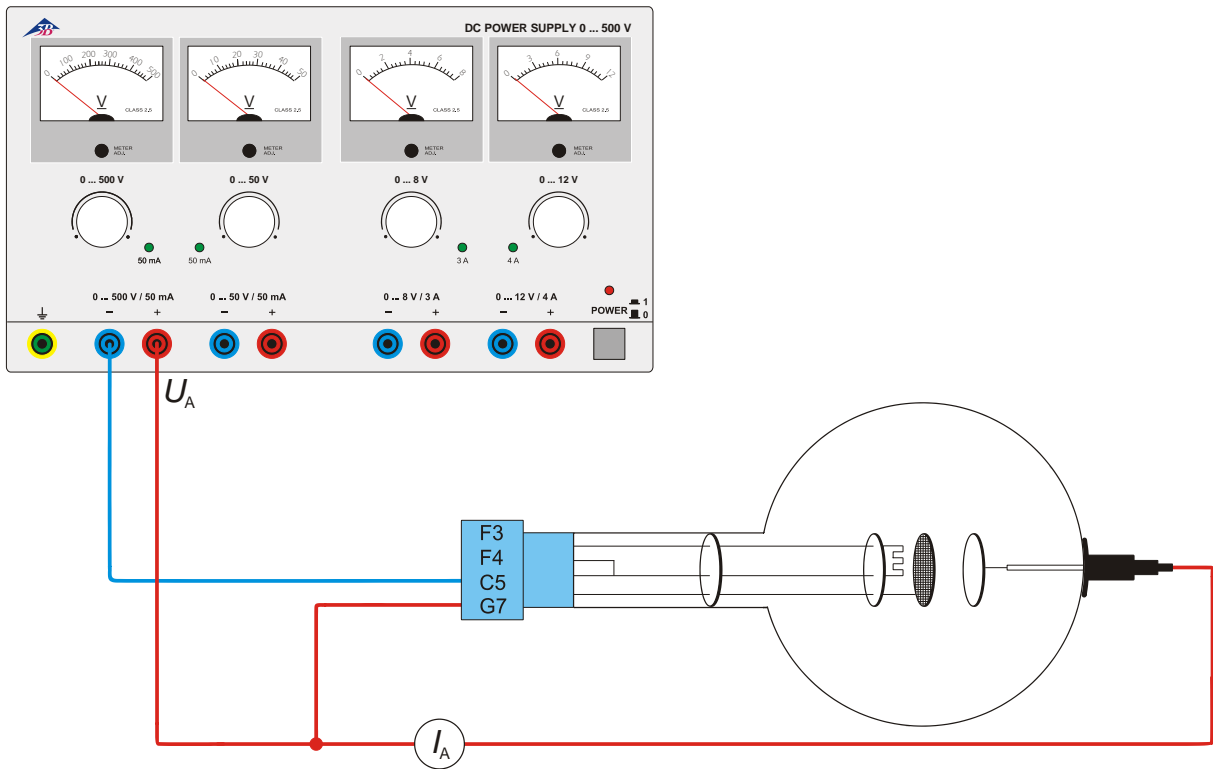

Fig.3 Self-sustaining discharge

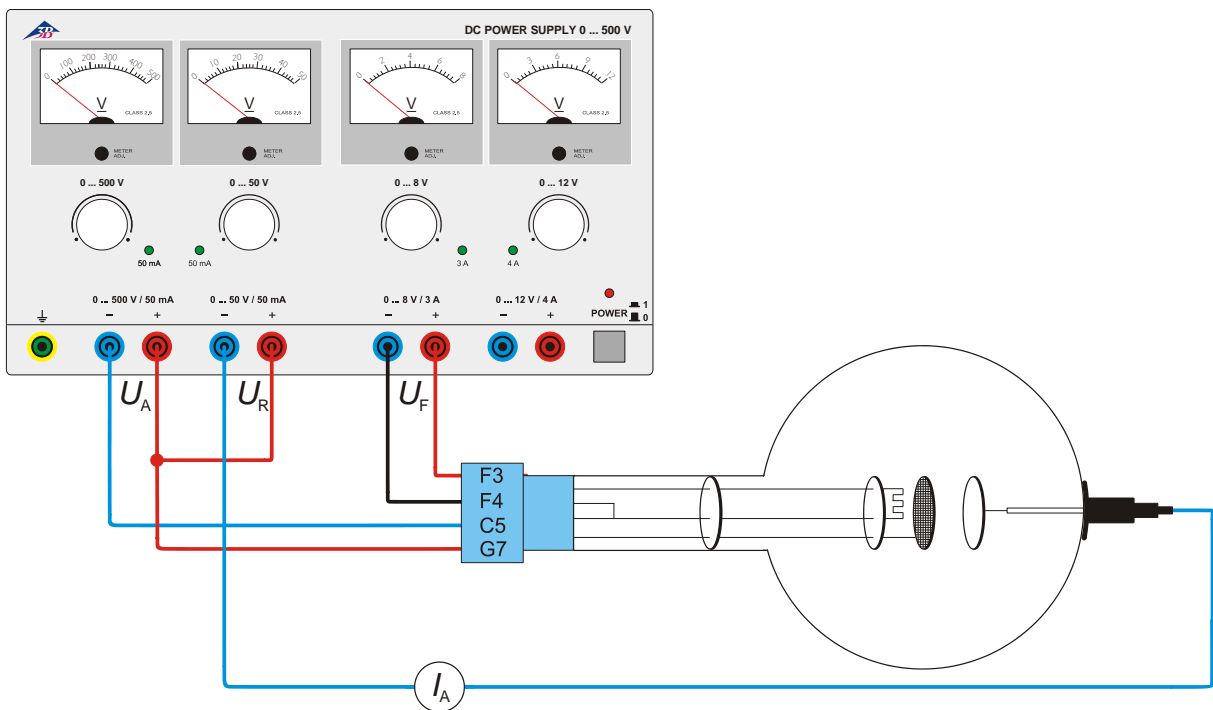

Fig. 4 Franck-Hertz set-up