

**Foucault's Pendulum @115 V 1000747**

**Foucault's Pendulum @230 V 1000748**

## Instruction sheet

06/15 ALF

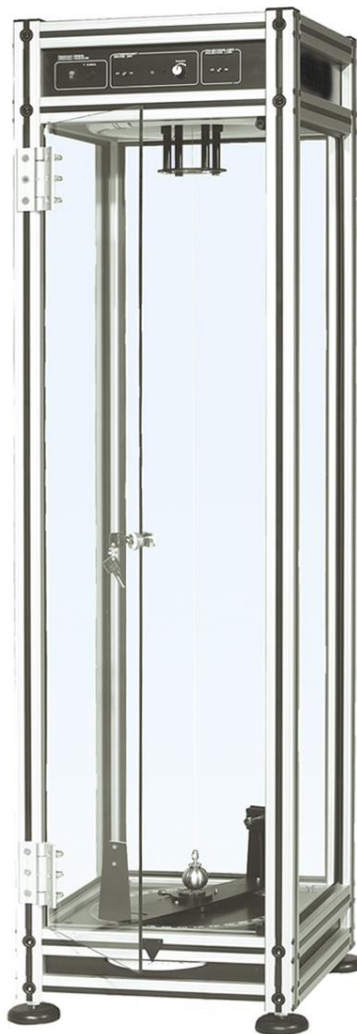

### 1. Safety instructions

- The glass housing should not be subjected to any mechanical load or stress. Caution: Danger of breakage and injury!
- Follow the instructions for positioning (4.1 Setup).
- When configuring the electrical excitation, do not turn up the electricity so high that the bob hits the glass wall.

### 2. Description

Foucault's pendulum is used for the quantitative measurement and qualitative demonstration of the earth's rotation.

In 1850, Frenchman Jean Bernard Leon Foucault demonstrated the rotation of the earth for the first time with the help of a pendulum. To do so, he used a pendulum with a weight of 28 kg and a length of 67 m.

The 3B Foucault pendulum is a compact apparatus which maintains the amplitude of the pendulum by constant excitation. A Charron ring (see Fig. 2) prevents any elliptical motion. By virtue of this, long-term measurements are possible. A measuring device consisting of an angle scale divided into minutes (Fig. 1) enables quick and precise measurements. The housing

permits clear visibility from all sides and allows several observers to simultaneously observe the change in the direction of oscillation. The apparatus can be operated during the experiment without having to open the door. An exact adjustment of Foucault's pendulum can be carried out easily with the aid of accessories.

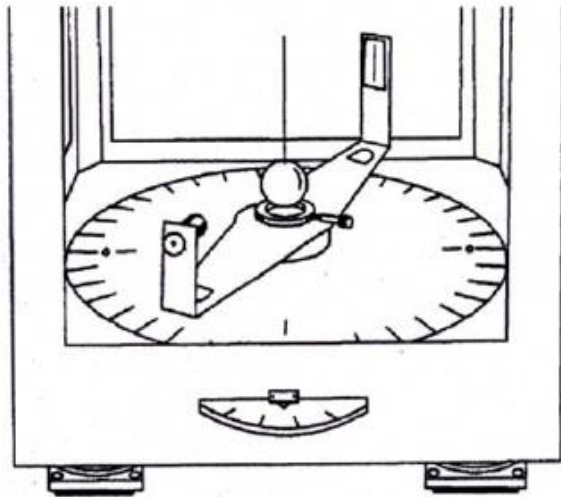

Fig. 1 Scale for measurement of angle

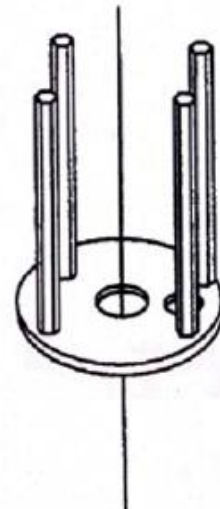

Fig. 2 Charron ring

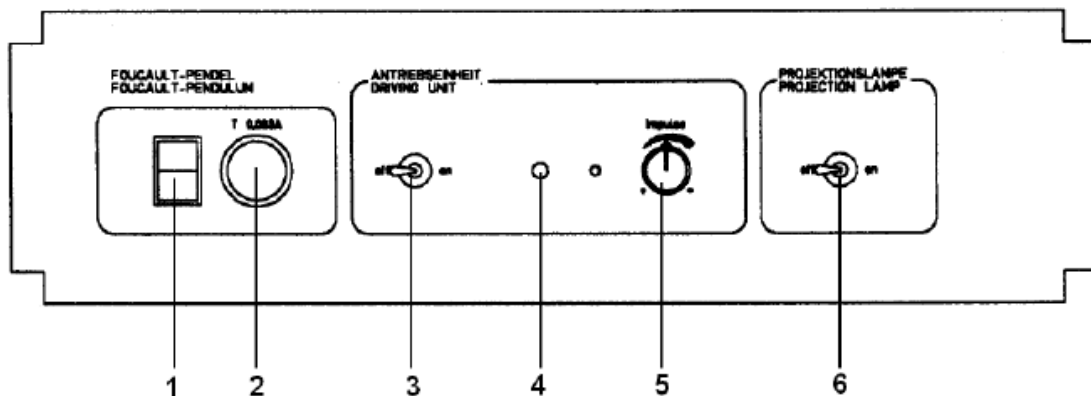

Fig. 3 Control panel 1 Main switch, 2 Fuse, 3 Drive unit switch, 4 Control lamp, 5 Pulse regulator, 6 Projection lamp switch

## 2.1 Basic functions

### 2.1.1 Continuous swinging of the pendulum

An electromagnet with a radially symmetric magnetic field is mounted exactly in the middle of the pendulum's path. The magnet only has an effect when the pendulum is moving towards the centre. The electromagnet is controlled by a photovoltaic cell which registers the shadow of the pendulum motion by the light provided by a built-in fluorescent lamp. The pendulum is excited in a way such that its amplitude remains constant.

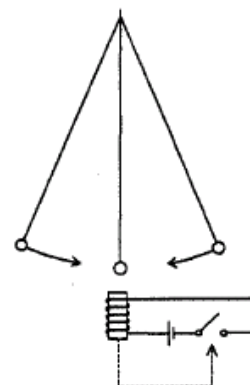

Fig. 4

### 2.1.2 Measurement of the angle of precession

The angular velocity of the pendulum's precession is  $\omega$

$$\omega = \omega_e \cdot \sin \theta$$

where  $\omega_e$  = angular velocity of the earth (= 360°/day = 15°/hour) and  $\theta$  = latitude of the place of experimentation.

In temperate latitudes, the pendulum swings at approx. 8°-13° per hour. By virtue of its measuring scale (see Fig. 5), Foucault's

pendulum allows measurements to be carried out quickly and effectively, taking up just a few minutes of the lesson.

Move the source of light for the situation in Fig. 5c until the projection of the string stops moving on the screen (Fig. 5b). By this means, the present plane of oscillation can be accurately determined. A 36:1 vernier scale enables the measurement of angles <1°.

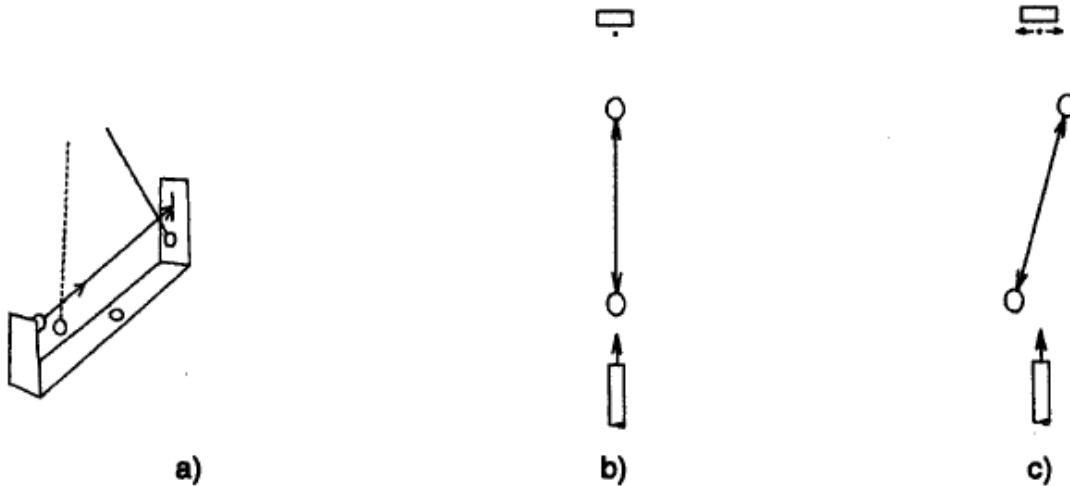

Fig. 5 Angular measurement by shadow projection (swing of the pendulum observed from above)

### 2.1.3 Preventing elliptical motion of the pendulum

During the experiment, the pendulum must swing in one and the same plane (Fig. 6b). If the pendulum begins to swing in an elliptical fashion (Fig. 6c), other factors apart from the rotation of the earth have an influence on its rotational motion. Accurate measurements are therefore not possible.

In order to prevent elliptical motion, a ring is used in Foucault's pendulum (see Fig. 2). At an ideal amplitude setting, the ring has no influence on the plane of the pendulum. It does, however, suppress any component of the motion that is perpendicular to the plane of oscillation at its endpoint.

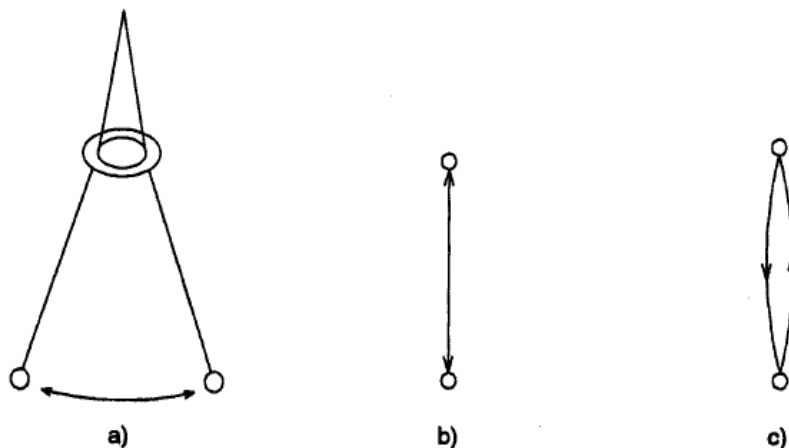

Fig. 6 Preventing elliptical motion (swing of the pendulum observed from above)

### 3. Technical specifications

Suspension string:	120 cm
Metal pendulum bob:	38 mm Ø, 230 g
Protractor disc:	340 mm Ø, 360°
Divisions:	Vernier 0.1°
String projection by means of a light beam that can be switched on and off	
Incandescent lamp with lens:	E10 3.7 V, 0.3 A
Excitation:	Electromagnetic pulse excitation mechanism, integrated photovoltaic cell for synchronisation, switch for regulating the amplitude, indicator lamp for excitation
Housing:	Glazed metal housing with door, 40x40x150 cm <sup>3</sup> Stand base with 4 adjustable feet for plumb vertical positioning
Lighting:	Fluorescent tube 36 W
Power supply:	
1000747:	115 V, 50/60 Hz
1000748:	230 V, 50/60 Hz
Mains fuse:	0.063 A, slow blow

### 4. Operation

#### 4.1 Setup

##### 4.1.1 Assembly

- Set up Foucault's pendulum on a horizontal surface with a stable foundation.
- Using your hands, check the housing and the ring for vibrations. If any vibrations are felt, it means that this place is unsuitable. If a floor is able to vibrate, a spot must be chosen where few people are likely to pass close by. Pay special attention to air conditioning units and other appliances that are capable of generating vibrations.
- Avoid direct solar radiation, as this may make it difficult to register the shadow projected from the string and possibly even cause incorrect triggering of the photovoltaic cell.

##### 4.1.2 Mounting the pendulum

- Set the distance between the pendulum bob and the electromagnet to approx. 3 mm. This distance is achieved when the bob barely touches the plate that can be laid over the electromagnet in order to make this adjustment (see Fig. 7). If the distance is too great, the effect of the excitation mechanism is weaker.

- If the bob is suspended for a longer period, then the distance should be checked, because the string can stretch by 1 to 2 mm.

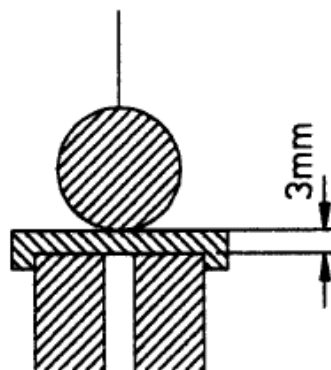

Fig. 7 Distance between the pendulum bob and the electromagnet

##### 4.1.3 Horizontal adjustment

- Insert the adjustment cylinder onto the measuring scale and insert the pendulum bob into this cylinder (see Fig. 8).
- For correct adjustment, turn the feet of the stand base till a suitable height is attained. Adjustment becomes easier when two feet of the stand base are moved simultaneously.
- The bob must be suspended exactly in the middle of the cylinder.

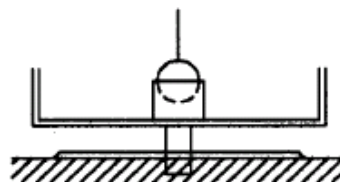

Fig. 8 Horizontal adjustment

##### 4.1.4 String projection

- After switching on the projection lamp, while retaining the suspended bob in the adjustment cylinder, make sure that the string projection covers the vertical line on the screen.
- This factory calibration may need to be carried out once again when the bulb has to be changed (see 4.3).

#### 4.2 Experimental procedure

- Check whether all preparations described in 4.1 have been carried out.
- If the experiment is to be carried out only with the natural swing of the pendulum, then the switch for excitation of the pendulum must be switched to "OFF". In this case, the swing of the pendulum is reduced to less than 1/3 of its initial amplitude in 15 minutes. The measurements must be conducted within this period.

- If the experiment is conducted with excitation, then the amplitude must be observed for approx. 5 minutes and, if required, should be corrected using the excitation adjustment switch.
- Displace the pendulum bob by hand and release it. During the experiment, the pendulum must swing in one and the same plane. If it begins to swing in an elliptical path, the experiment will have to be stopped and restarted.
- Shut the door carefully.
- When the swinging motion becomes stable after a few minutes, set the protractor disc such that the projected image of the string coincides with the baseline.
- The measurement of the angle of rotation is conducted at the point where the string projection on the screen stops moving horizontally as the angle adjustment dial is turned.
- If the string projection unit does not move while the angular adjustment dial is rotating, then check whether the locking screw has been properly screwed down.
- Take readings of the approximate angle on the base plate and use the vernier scale to read the exact angle.

#### 4.3 Further instructions

- In the case of an excited pendulum, the fluorescent tube must be switched on, as it is a source of light for the photovoltaic sensor.
- The fastening screws for the string and the ring plate must be checked to ensure that they are secure. Measurements can be inaccurate, if the string fastening is not tight (Fig. 10).

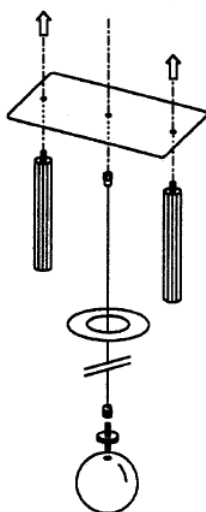

Fig. 10

- The centring of the ring is factory-adjusted. If a new setting is required, the following steps must be followed (Fig. 11):
- The pendulum must be aligned with the help of the adjustment cylinder (see 4.1.3).
- Insert the adjustment ring.
- Loosen the screws on the underside of the Charron ring without taking them out completely.
- Fit the adjustment ring in the middle of the Charron ring and move the Charron ring by knocking on it lightly till you see that the string is suspended exactly in the middle of the adjustment ring.
- Tighten the screws without displacing the ring.

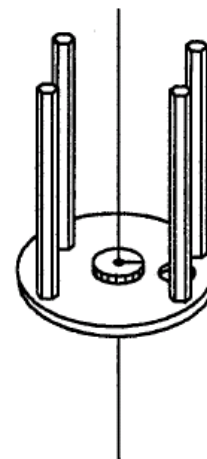

Fig. 11

- When changing the suspension string care should be taken to make sure the mounting bracket for the string is not displaced, as this would mean repeating the adjustments for the ring. As far as possible, only the string's own fastening screw should be involved in replacing the string.
- If the amplitude of the pendulum has not been adjusted accurately, then the plane of the pendulum can precess either too quickly or too slowly. For precision measurements, the ideal amplitude is determined by observing the precession of the plane of oscillation.
- Inaccuracies in the adjustment of the housing, centring of the ring and the amplitude of the pendulum, or poor surface conditions can have an adverse effect on the precession of the pendulum and can lead to the precession becoming either too slow or too quick.
- If the pendulum stops swinging, the following are possible causes:
  - The excitation has been switched off.
  - The fluorescent lamp has been switched off.

- Twists in the suspension string can induce measurement errors. In order to remove twists in the string, allow the string to hang freely for a few hours with the pendulum bob suspended from it.
- If the projection lamp does not light, the following are possible causes:
- The projection lamp has not been switched on.
- The bulb is loose. Remove the sleeve of the lamp by turning gently and fasten the bulb.
- The bulb is faulty. Remove the sleeve of the lamp by turning gently and replace the bulb.
- The sliding contacts are not making contact. Loosen the locking screw, gently press down the string projection unit and fasten it under this pressure. In case of further malfunctioning, loosen the locking screw and remove the string projection unit. Check the sliding contacts for any mechanical damage.
- If the string projection cannot be made to coincide with the screen, remove the sleeve of the lamp by turning gently and direct the light beam on to the screen by applying radial pressure on the lamp socket. For verification, suspend the bob in the adjustment cylinder. If the string projection does not cover the vertical line, then the factory settings must be recalibrated. Loosen the two fastening screws of the lamp socket and move the lamp socket horizontally till the string projection covers the vertical line.

## 5. Storage, cleaning and disposal

- Keep the equipment in a clean, dry and dust-free place.
- Before cleaning the equipment, disconnect it from its power supply.
- Do not clean the unit with volatile solvents or abrasive cleaners.
- Use a soft, damp cloth to clean it.
- The packaging should be disposed of at local recycling points.
- Should you need to dispose of the equipment itself, never throw it away in normal domestic waste. Local regulations for the disposal of electrical equipment will apply.

